

NFPA 30

Flammable and Combustible Liquids Code

2003 Edition

Copyright © 2003, National Fire Protection Association, All Rights Reserved

This edition of NFPA 30, *Flammable and Combustible Liquids Code*, was prepared by the Technical Committees involved with the Flammable and Combustible Liquids project, released by the Technical Correlating Committee on Flammable and Combustible Liquids, and acted on by NFPA at its May Association Technical Meeting held May 18–21, 2003, in Dallas, TX. It was issued by the Standards Council on July 18, 2003, with an effective date of August 7, 2003, and supersedes all previous editions.

This edition of NFPA 30 was approved as an American National Standard on July 18, 2003.

Origin and Development of NFPA 30

From 1913 to 1957, this document was written as a model municipal ordinance known as the *Suggested Ordinance for the Storage, Handling, and Use of Flammable Liquids*. In 1957, the format was changed to a code, although the technical requirements and provisions remained the same. During the 90-year period of existence of NFPA 30, numerous revised editions have been published as dictated by experience and advances in technology.

A brief review of the major changes adopted over the previous six editions follows. In 1984, the chapter covering automotive and marine service stations was removed from NFPA 30 and was used as the basis for a separate document, NFPA 30A, *Automotive and Marine Service Station Code*, now titled *Code for Motor Fuel Dispensing Facilities and Repair Garages*. In 1987, Chapter 5 (Industrial Plants), Chapter 6 (Bulk Plants and Terminals), Chapter 7 (Process Plants), and Chapter 8 (Refineries, Chemical Plants, and Distilleries) were combined into a single chapter on operations. In 1990, a new section was added to Chapter 4 to address hazardous materials storage lockers, and more detailed guidance was added to Section 5-3 to address ventilation of enclosed process areas and for estimation of fugitive emissions. In 1993, Chapter 4, Container and Portable Tank Storage, was completely rewritten so that its requirements were presented more clearly, especially for mercantile occupancies. In addition, changes were made to the tank diking provisions to allow combined remote impounding and diking systems and to provide relief from the spill control requirements for certain secondary containment-type tanks.

In 1996, the following major changes were incorporated: requirements for temporary and permanent closure of underground storage tanks; requirements for tightness testing of tanks

Copyright NFPA

of specific design; recognition of intermediate bulk containers; mandatory fire protection design criteria for inside storage of liquids.

In 2000, the following major changes were incorporated: complete editorial rewrites of Chapter 2, Tank Storage, and Chapter 3, Piping Systems; requirements for vaults for aboveground tanks and for protected aboveground tanks; recognition of specific nonmetallic intermediate bulk containers for Class II and Class III liquids, along with fire protection system design criteria; simplified spill containment and drainage requirements; new fire protection design criteria for a number of flammable and combustible liquid commodities; expansion of the requirements in Subsection 5.3.3.1 for construction and separation of process buildings; new Section 5.4 was added to address recirculating heat transfer fluid heating systems; new Section 5.11 was added to address solvent recovery distillation units; consolidation into a new Chapter 6 of all requirements for hazardous location electrical area classification.

This 2003 edition of NFPA 30 incorporates the following changes:

- (1) All mandatory referenced publications have been consolidated into a new Chapter 2 and all definitions into a new Chapter 3. All subsequent chapters have been renumbered accordingly.
- (2) Numerous occupancy definitions have either been added or corrected to correlate with NFPA 1, *Uniform Fire Code*[™]; NFPA 101[®], *Life Safety Code*[®]; and NFPA 5000[™], *Building Construction and Safety Code*[™].
- (3) Separation distance requirements have been reduced in Table 4.3.2.1.1(a) for protected aboveground tanks, and separation distance requirements for tanks in vaults constructed in accordance with 4.2.7 have been eliminated.
- (4) Special operating requirements have been added in 4.6.1.5 for shop-fabricated aboveground tanks with abnormally long vertical piping for fill and/or vent lines.
- (5) New criteria have been added for maximum allowable container sizes in Table 6.2.3 and in appropriate paragraphs of Chapter 6.
- (6) A new Table 6.8.2(k) contains fire protection design criteria for unsaturated polyester resins, including appropriate amendments to Figure 6.8.2(a) and Figure 6.8.5.
- (7) A new Annex D.5 contains suggested fire protection design criteria using high-expansion foam systems for protection of liquids in 1-gallon plastic containers.
- (8) Revisions have been made to the Section 7.3 spacing requirements and construction requirements for process buildings.
- (9) Special requirements have been added in Section 7.4 for insulated piping for recirculating heat transfer systems.
- (10) A new 7.13.3.2 provides guidance prohibiting permanent interconnections between fire water systems and process water systems.

Technical Correlating Committee on Flammable and Combustible Liquids

Edward Hildebrandt, Chair
Village of Morton Grove, IL [E]

John A. Davenport, West Point, VA [I]

James D. Kieffer, Kieffer & Associates, Inc., Canada [SE]

Richard S. Kraus, Petroleum Safety Consultants, VA [M]
Rep. American Petroleum Institute

William E. Rehr, BOCA International, Inc., IL [E]

Douglas A. Rivers, 3M Company, MN [U]

Orville M. Slye, Jr., Loss Control Associates Inc., PA [SE]

Hugh Patrick Toner, Society of the Plastics Industry, Inc., DC [M]

Alternates

Clark D. Shepard, ExxonMobil Corporation, VA [M]
(Alt. to R. S. Kraus)

Nonvoting

David L. Blomquist, Blomquist Fire Protection Engineering, CA
(Member Emeritus)

Gary R. Glowinski, Glowinski & Associates, Inc., WI [SE]

Donald M. Johnson, Walnut Creek, CA
(Member Emeritus)

Anthony M. Ordile, Loss Control Associates, Inc., PA

Brooke B. Smith, Jr., Aspen Engineering Inc., CO

Jack Woycheese, Hughes Associates, Inc., CA

Robert P. Benedetti, NFPA Staff Liaison

This list represents the membership at the time the Committee was balloted on the final text of this edition. Since that time, changes in the membership may have occurred. A key to classifications is found at the back of the document.

NOTE: Membership on a committee shall not in and of itself constitute an endorsement of the Association or any document developed by the committee on which the member serves.

Copyright NFPA

Committee Scope: This Committee shall have primary responsibility for documents on safeguarding against the fire and explosion hazards associated with the storage, handling, and use of flammable and combustible liquids; and classifying flammable and combustible liquids.

Technical Committee on Fundamentals (FLC-FUN)

Gary R. Glowinski, *Chair*
Glowinski & Associates, Inc., WI [SE]

Robert P. Benedetti, *Nonvoting Secretary*
NFPA, MA

Gerald A. Gordon, Greif Brothers Corporation, IL [M]

Dwight H. Havens, City of Phoenix Fire Department, AZ [E]

Jay J. Jablonski, HSB Professional Loss Control, TX [I]

James D. Kieffer, Kieffer & Associates, Inc., Canada [SE]

Richard S. Kraus, Petroleum Safety Consultants, VA [M]

Jack Woycheese, Hughes Associates, Inc., CA [SE]

Cherilyn A. Zeisset, Pennzoil-Quaker State Company, TX [M]

Alternates

Peter R. Apostoluk, Greif Brothers Corporation, IL [M]
(Alt. to G. Gordon)

Joseph L. Scheffey, Hughes Associates, Inc. MD [SE]
(Alt. to J. Woycheese)

Kenneth H. Turnbull, Texaco, TX [M]
(Alt. to R. S. Kraus)

Robert P. Benedetti, NFPA Staff Liaison

This list represents the membership at the time the Committee was balloted on the final text of this edition. Since that time, changes in the membership may have occurred. A key to classifications is found at the back of the document.

NOTE: Membership on a committee shall not in and of itself constitute an endorsement of the Association or any document developed by the committee on which the member serves.

Committee Scope: This Committee shall have primary responsibility for documents or portions of documents on the basic requirements for safeguarding against the fire and

Copyright NFPA

explosion hazards associated with the storage and handling of flammable and combustible liquids. This Committee shall also have responsibility for definitions related to flammable and combustible liquids and for criteria for the classification of flammable and combustible liquids.

Technical Committee on Operations (FLC-OPS)

Jack Woycheese, *Chair*
Hughes Associates, Inc., CA [SE]

Brian J. Clark, Liberty Mutual Group, CT [I]
Rep. Alliance of American Insurers

Gary R. Glowinski, Glowinski & Associates, Inc., WI [SE]

John P. Hartmann, John Hartmann & Associates, IL [SE]

Dwight H. Havens, City of Phoenix Fire Department, AZ [E]

Richard J. Hild, DuPont Performance Coatings, DE [M]

Edward Hildebrandt, Village of Morton Grove, IL [E]

Richard B. Hopkinson, Kemper Insurance Companies, MA [I]

Jay J. Jablonski, HSB Professional Loss Control, TX [I]

Joshy Paul Kallungal, Office of the Fire Marshal, Canada [E]

James D. Kieffer, Kieffer & Associates, Inc., Canada [SE]

Gregory D. Kirby, CYTEC Industries, Incorporated, WV [U]
Rep. American Chemistry Council

David C. Kirby, Baker Engineering & Risk Consulting, WV [SR]

Donald J. Kohn, Kohn Engineering, PA [SE]

Richard S. Kraus, Petroleum Safety Consultants, VA [M]
Rep. American Petroleum Institute

Larry M. Kreh, PPG Industries, Inc., PA [M]

John A. LeBlanc, FM Global, MA [I]

Robert E. McClay, East Carolina University, NC [SE]
Rep. American Society of Safety Engineers

Copyright NFPA

Thaddeus A. Nosal, American Insurance Services Group, NY [I]

Anthony M. Ordile, Loss Control Associates, Inc., PA [SE]

Arlyn H. Poppen, 3M Company-Industrial Markets, MN [U]

Susan M. Preske, St. Paul Insurance Companies, NY [I]

Robert N. Renkes, Petroleum Equipment Institute, OK [M]

George A. Seuss, Jr., Verlan Fire Insurance Company, MD [I]

Clark D. Shepard, ExxonMobil Corporation, VA [M]

Brooke B. Smith, Jr., Aspen Engineering Inc., CO [SE]

Scott M. Tyler, Duke Engineering and Services, IL [U]
Rep. Edison Electric Institute

Alternates

John A. Davenport, West Point, VA [I]
(Voting Alt. to GEGAPS Rep.)

Claire V. De Taeye, LMG Property Engineering, NY [I]
(Alt. to B. J. Clark)

David W. Owen, ExxonMobil Corporation, VA [M]
(Alt. to C. D. Shepard)

Douglas A. Rivers, 3M Company, MN [U]
(Alt. to A. H. Poppen)

Joseph L. Scheffey, Hughes Associates, Inc., MD [SE]
(Alt. to J. Woycheese)

Orville M. Slye, Jr., Loss Control Associates Inc., PA [SE]
(Alt. to A. M. Ordile)

Kevin F. Sykora, The Sherwin-Williams Company, OH [SE]
(Alt. to R. E. McClay)

Nonvoting

Michael B. Moore, U.S. Occupational Safety & Health Administration, DC

Terence P. Smith, U.S. Department of Labor, DC
(Nonvoting Alt. to M. B. Moore)

Robert P. Benedetti, NFPA Staff Liaison

This list represents the membership at the time the Committee was balloted on the final text of this edition. Since that time, changes in the membership may have occurred. A key to classifications is found at the back of the document.

NOTE: Membership on a committee shall not in and of itself constitute an endorsement of the Association or any document developed by the committee on which the member serves.

Committee Scope: This Committee shall have primary responsibility for documents or portions of documents on safeguarding against the fire and explosion hazards associated with operations that involve the handling, transfer, and use of flammable and combustible liquids, either as a principal activity or as an incidental activity.

Technical Committee on Storage and Warehousing of Containers and Portable Tanks (FLC-SWC)

Anthony M. Ordile, *Chair*
Loss Control Associates, Inc., PA [SE]

John A. Davenport, West Point, VA [I]
Rep. GE Global Asset Protection Services

John J. Foley, The RJA Group, Inc., GA [SE]

Gary R. Glowinski, Glowinski & Associates, Inc., WI [SE]

Gerald A. Gordon, Greif Brothers Corporation, IL [M]

Dwight H. Havens, City of Phoenix Fire Department, AZ [E]

Richard J. Hild, DuPont Performance Coatings, DE [M]
Rep. National Paint & Coatings Association

Edward Hildebrandt, Village of Morton Grove, IL [E]

Joshy Paul Kallungal, Office of the Fire Marshal, Canada [E]

James D. Kieffer, Kieffer & Associates, Inc., Canada [SE]

Gregory D. Kirby, CYTEC Industries, Incorporated, WV [U]
Rep. American Chemistry Council

David C. Kirby, Baker Engineering & Risk Consultants, WV [SE]

Richard S. Kraus, Petroleum Safety Consultants, VA [M]

Copyright NFPA

Rep. American Petroleum Institute

John A. LeBlanc, FM Global, MA [I]

Jerry Massa, CP Louisiana, Incorporated, LA [M]
Rep. Steel Shipping Container Institute

Roger McKim, LMG Property Engineering, OR [I]
Rep. Alliance of American Insurers

Navin D. Mehta, U.S. Department of Defense-Defense Logistic Agency, VA [U]

Martin J. Pabich, Underwriters Laboratories Inc., IL [RT]

Lee Rindfuss, Marsh Risk Consulting, MA [I]

Douglas A. Rivers, 3M Company, MN [U]

Joseph L. Scheffey, Hughes Associates, Inc., MD [SE]

Michael Spence, Brown Sprinkler Corporation, KY [IM]
Rep. National Fire Sprinkler Association

Arthur M. Stevens, Stevens Associates, FL [M]
Rep. Safe-T-Way Manufacturing, Inc.

David C. Tabar, The Sherwin-Williams Company, OH [M]

William J. Tomes, TVA Fire and Life Safety, GA [U]
Rep. The Home Depot

Hugh Patrick Toner, Society of the Plastics Industry, Inc., DC [M]

Martin H. Workman, The Viking Corporation, MI [M]
Rep. American Fire Sprinkler Association, Inc.

Alternates

Peter R. Apostoluk, Greif Brothers Corporation, IL [M]
(Alt. to G. A. Gordon)

Tracey D. Bellamy, TVA Fire and Life Safety, GA [U]
(Alt. to W. J. Tomes)

Robert H. Christopher, R-C Associates, DE [M]
(Alt. to R. J. Hild)

Copyright NFPA

Brian J. Clark, Liberty Mutual Group, CT [I]
(Alt. to R. McKim)

Dennis R. Freezer, Steel Shipping Container Institute, DC [M]
(Alt. to J. Massa)

Pravinray D. Gandhi, Underwriters Laboratories Inc., IL [RT]
(Alt. to M. J. Pabich)

Douglas L. Jeffries, Chevron Research & Technology Company, CA [M]
(Alt. to R. S. Kraus)

Craig A. Martens, Lake Havasu City Fire Department, AZ [E]
(Alt. to D. H. Havens)

Arlyn H. Poppen, 3M Company-Industrial Markets, MN [U]
(Alt. to D. A. Rivers)

Orville M. Slye, Jr., Loss Control Associates Inc., PA [SE]
(Alt. to A. M. Ordile)

Ronald J. Stephens, Allan Automatic Sprinkler Corporation of Southern California, CA [IM]
(Alt. to M. Spence)

David C. Swenson, The Sherwin-Williams Company, OH [M]
(Alt. to D. C. Tabar)

Daniel J. Venier, Marsh USA Inc., MI [I]
(Alt. to L. Rindfuss)

Jack Woycheese, Hughes Associates, Inc., CA [SE]
(Alt. to J. L. Scheffey)

Robert P. Benedetti, NFPA Staff Liaison

This list represents the membership at the time the Committee was balloted on the final text of this edition. Since that time, changes in the membership may have occurred. A key to classifications is found at the back of the document.

NOTE: Membership on a committee shall not in and of itself constitute an endorsement of the Association or any document developed by the committee on which the member serves.

Committee Scope: This Committee shall have primary responsibility for documents or portions of documents on safeguarding against the fire and explosion hazards associated with the storage, warehousing, and display merchandising of flammable and combustible liquids in containers and in portable tanks whose capacity does not exceed 2500 liters (660 gallons).

Technical Committee on Tank Storage and Piping Systems (FLC-TAN)

Brooke B. Smith, Jr., *Chair*
Aspen Engineering Inc., CO [SE]

Gary T. Austerman, Burns & McDonnell Engineering Co., MO [SE]

Jon V. Brannan, Underwriters Laboratories Inc., IL [RT]

Sullivan D. Curran, Fiberglass Tank & Pipe Institute, TX [M]

Charles A. Davis, URS Corporation, FL [SE]

Wayne Geyer, Steel Tank Institute, IL [M]

Robert D. Grausam, PARTNER RE US, CT [I]

John P. Hartmann, John Hartmann & Associates, IL [SE]

Dwight H. Havens, City of Phoenix Fire Department, AZ [E]

Douglas L. Jeffries, Chevron Research & Technology Company, CA [U]
Rep. American Petroleum Institute

Joshy Paul Kallungal, Office of the Fire Marshal, Canada [E]

James D. Kieffer, Kieffer & Associates, Inc., Canada [SE]

Gregory D. Kirby, CYTEC Industries, Incorporated, WV [U]
Rep. American Chemistry Council

David C. Kirby, Baker Engineering & Risk Consultants, WV [SE]

Michael D. Lattner, Morrison Brothers Company, IA [M]

Armin E. Mittermaier, Data Action, IN [U]
Rep. Petroleum Marketers Association of America

Susan M. Preske, St. Paul Insurance Companies, NY [I]

Robert N. Renkes, Petroleum Equipment Institute, OK [M]

David P. Saporito, Kemper Insurance Companies, AZ [I]

Clark D. Shepard, ExxonMobil Corporation, VA [U]

Orville M. Slye, Jr., Loss Control Associates Inc., PA [SE]

Brian P. Stuber, Oldcastle Precast/Utility Vault, AZ [M]

Jack Woycheese, Hughes Associates, Inc., CA [SE]

Andrea R. Zajac, Michigan Department of Environmental Quality, MI [E]

Cherilyn A. Zeisset, Pennzoil-Quaker State Company, TX [U]

Alternates

John A. Davenport, West Point, VA [I]
(Voting Alt. to GEGAPS Rep.)

Rodney Hoke, URS Corporation, FL [SE]
(Alt. to C. A. Davis)

Shari L. Hunter, Underwriters Laboratories Inc., CA [RT]
(Alt. to J. V. Brannan)

Makhoul (Mike) T. Kadri, Michigan Department of Environmental Quality, MI [E]
(Alt. to A. R. Zajac)

Richard S. Kraus, Petroleum Safety Consultants, VA [U]
(Alt. to D. L. Jeffries)

Patrick A. McLaughlin, McLaughlin & Associates, RI [M]
(Alt. to S. D. Curran)

Anthony M. Ordile, Loss Control Associates, Inc., PA [SE]
(Alt. to O. M. Slye, Jr.)

David W. Owen, ExxonMobil Corporation, VA [U]
(Alt. to C. D. Shepard)

Jeffrey M. Shapiro, International Code Consultants, TX [M]
(Alt. to B. P. Stuber)

Nonvoting

David L. Blomquist, Blomquist Fire Protection Engineering, CA
(Member Emeritus)

Donald M. Johnson, Walnut Creek, CA

Copyright NFPA

(Member Emeritus)

Robert P. Benedetti, NFPA Staff Liaison

This list represents the membership at the time the Committee was balloted on the final text of this edition. Since that time, changes in the membership may have occurred. A key to classifications is found at the back of the document.

NOTE: Membership on a committee shall not in and of itself constitute an endorsement of the Association or any document developed by the committee on which the member serves.

Committee Scope: This Committee shall have primary responsibility for documents or portions of documents on safeguarding against the fire and explosion hazards associated with the storage of flammable and combustible liquids in fixed aboveground and underground tanks of any size, including tanks in buildings, except as specifically covered by other NFPA documents, and with the installation of piping systems for flammable and combustible liquids. This Committee shall also have primary responsibility for documents or portions of documents on safeguarding against the fire and explosion hazards associated with the storage of flammable and combustible liquids in portable tanks whose capacity exceeds 2500 liters (660 gallons).

NFPA 30
Flammable and Combustible Liquids Code
2003 Edition

IMPORTANT NOTE: This NFPA document is made available for use subject to important notices and legal disclaimers. These notices and disclaimers appear in all publications containing this document and may be found under the heading “Important Notices and Disclaimers Concerning NFPA Documents.” They can also be obtained on request from NFPA or viewed at www.nfpa.org/disclaimers.

NOTICE: An asterisk (*) following the number or letter designating a paragraph indicates that explanatory material on the paragraph can be found in Annex A.

Changes other than editorial are indicated by a vertical rule beside the paragraph, table, or figure in which the change occurred. These rules are included as an aid to the user in identifying changes from the previous edition. Where one or more complete paragraphs have been deleted, the deletion is indicated by a bullet (•) between the paragraphs that remain.

A reference in brackets [] following a section or paragraph indicates material that has been extracted from another NFPA document. As an aid to the user, Annex H lists the complete title and edition of the source documents for both mandatory and nonmandatory extracts. Editorial changes to extracted material consist of revising references to an appropriate division in this document or the inclusion of the document number with the division number when the reference is to the original document. Requests for interpretations or revisions of extracted text shall be sent to the technical committee responsible for the source document.

Information on referenced publications can be found in Chapter 2 and Annex H.

Chapter 1 Administration

Copyright NFPA

1.1 Scope.

1.1.1* This code shall apply to the storage, handling, and use of flammable and combustible liquids, including waste liquids, as herein defined and classified.

1.1.2 This code shall not apply to the following:

- (1)* Any liquid that has a melting point equal to or greater than 37.8°C (100°F) or that does not meet the criteria for fluidity given in the definition for *liquid* in Section 1.7
- (2) Any liquefied gas or cryogenic liquid as defined in Chapter 3
- (3)* Any liquid that does not have a flash point, but which is capable of burning under certain conditions; such liquids include certain halogenated hydrocarbons and certain mixtures of flammable or combustible liquids and halogenated hydrocarbons
- (4)* Any aerosol product
- (5) Any mist, spray, or foam



1.1.3 This code shall also not apply to the following:

- (1)* Transportation of flammable and combustible liquids as governed by the U.S. Department of Transportation
- (2)* Storage, handling, and use of fuel oil tanks and containers connected with oil-burning equipment

1.2* Purpose.

The purpose of this code shall be to provide reasonable requirements for the safe storage and handling of flammable and combustible liquids.

1.3 Application.

Chapter 4 and Chapter 5 shall apply to bulk storage of liquids in tanks and similar vessels. Chapter 6 shall apply to storage of liquids in containers and portable tanks in storage areas and in warehouses. Chapter 7 shall apply to handling of liquids in manufacturing and related operations and processes. Chapter 8 shall apply to electrical systems.

1.4* Retroactivity.

The provisions of this code shall be considered necessary to provide a reasonable level of protection from loss of life and property from fire and explosion. They shall reflect situations and the state of the art prevalent at the time the code was issued. Unless otherwise noted, it shall not be intended that the provisions of this code be applied to facilities, equipment, structures, or installations that were existing or approved for construction or installation prior to the effective date of this code, except in those cases where it is determined by the authority having jurisdiction that the existing situation involves a distinct hazard to life or adjacent property.

1.5 Equivalency.

1.5.1 Nothing in this code shall be intended to prevent the use of systems, methods, or devices of equivalent or superior quality, strength, fire resistance, effectiveness, durability, or safety over those prescribed by this code, provided that technical documentation is submitted to the authority having jurisdiction to demonstrate equivalency and the system, method, or device is approved for the intended purpose.

1.5.2 The provisions of this code shall be permitted to be altered at the discretion of the authority having jurisdiction after consideration of special situations, such as topographical conditions of the site, presence or absence of protective features (e.g., barricades, walls, etc.), adequacy of building exits, the nature of the occupancy, proximity to buildings or adjoining property and the construction of such buildings, capacity and construction of proposed storage tanks and the nature of the liquids to be stored, the nature of the process, the degree to which private fire protection is provided, and the capabilities of the local fire department. Such alternate arrangements shall provide protection at least equivalent to that required by this code.

1.5.3 The provisions of this code shall also be permitted to be altered at the discretion of the authority having jurisdiction in cases where other regulations, such as those for environmental protection, impose requirements that are not anticipated by this code. Such alternate arrangements shall provide protection at least equivalent to that required by this code.

1.5.4 Installations made in accordance with the applicable requirements of the following standards shall be deemed to be in compliance with this code:

- (1) NFPA 30A, *Code for Motor Fuel Dispensing Facilities and Repair Garages*
- (2) NFPA 32, *Standard for Drycleaning Plants*
- (3) NFPA 33, *Standard for Spray Application Using Flammable or Combustible Materials*
- (4) NFPA 34, *Standard for Dipping and Coating Processes Using Flammable or Combustible Liquids*
- (5) NFPA 35, *Standard for the Manufacture of Organic Coatings*
- (6) NFPA 36, *Standard for Solvent Extraction Plants*
- (7) NFPA 37, *Standard for the Installation and Use of Stationary Combustion Engines and Gas Turbines*
- (8) NFPA 45, *Standard on Fire Protection for Laboratories Using Chemicals*
- (9) Chapter 10 of NFPA 99, *Standard for Health Care Facilities*

1.6 Enforcement.

This code shall be administered and enforced by the authority having jurisdiction designated by the governing authority. *(See Annex G for sample wording for enabling legislation.)*

Copyright NFPA

1.7 Definition and Classification of Liquids.

1.7.1 Scope. Section 1.7 shall establish a uniform system of defining and classifying flammable and combustible liquids for the purpose of proper application of this code. This section shall apply to any liquid within the scope of, and subject to, the requirements of this code.

1.7.1.1 Section 1.7 shall not apply to mists, sprays, or foams.

1.7.1.2 Section 1.7 shall not apply to liquids that do not have flash points, but are capable of burning under certain conditions; such liquids include certain halogenated hydrocarbons and certain mixtures of flammable or combustible liquids and halogenated hydrocarbons. [See A.1.1.2(3).]

1.7.2 Definitions. For the purpose of this section, the terms in 1.7.2.1 through 1.7.2.4 shall have the definitions given.

1.7.2.1* Boiling Point. The temperature at which the vapor pressure of a liquid equals the surrounding atmospheric pressure. For purposes of defining the boiling point, atmospheric pressure shall be considered to be 14.7 psia (760 mm Hg). For mixtures that do not have a constant boiling point, the 20 percent evaporated point of a distillation performed in accordance with ASTM D 86, *Standard Method of Test for Distillation of Petroleum Products*, shall be considered to be the boiling point.

1.7.2.2* Flash Point. The minimum temperature of a liquid at which sufficient vapor is given off to form an ignitable mixture with the air, near the surface of the liquid or within the vessel used, as determined by the appropriate test procedure and apparatus specified in 1.7.4.

1.7.2.3 Liquid. Any material that has a fluidity greater than that of 300 penetration asphalt when tested in accordance with ASTM D 5, *Standard Method of Test for Penetration of Bituminous Materials*.

1.7.2.4* Vapor Pressure. The pressure, measured in pounds per square inch, absolute (psia), exerted by a liquid, as determined by ASTM D 323, *Standard Method of Test for Vapor Pressure of Petroleum Products (Reid Method)*.

1.7.3* Classification of Liquids. Any liquid within the scope of this code and subject to the requirements of this code shall be known generally as either a flammable liquid or a combustible liquid and shall be defined and classified in accordance with this subsection.

1.7.3.1 Combustible Liquid. Any liquid that has a closed-cup flash point at or above 100°F (37.8°C), as determined by the test procedures and apparatus set forth in 1.7.4. Combustible liquids are classified as Class II or Class III as follows: (1) *Class II Liquid* — any liquid that has a flash point at or above 100°F (37.8°C) and below 140°F (60°C); (2) *Class IIIA* — any liquid that has a flash point at or above 140°F (60°C), but below 200°F (93°C); (3) *Class IIIB* — any liquid that has a flash point at or above 200°F (93°C).

1.7.3.2* Flammable Liquid. Any liquid that has a closed-cup flash point below 100°F (37.8°C), as determined by the test procedures and apparatus set forth in 1.7.4. Flammable liquids are classified as Class I as follows: *Class I Liquid* — any liquid that has a closed-cup

flash point below 100°F (37.8°C) and a Reid vapor pressure not exceeding 40 psia (2068.6 mm Hg) at 100°F (37.8°C), as determined by ASTM D 323, *Standard Method of Test for Vapor Pressure of Petroleum Products (Reid Method)*. Class I liquids are further classified as follows: (1) *Class IA liquids* — those liquids that have flash points below 73°F (22.8°C) and boiling points below 100°F (37.8°C); (2) *Class IB liquids* — those liquids that have flash points below 73°F (22.8°C) and boiling points at or above 100°F (37.8°C); (3) *Class IC liquids* — those liquids that have flash points at or above 73°F (22.8°C), but below 100°F (37.8°C).

1.7.4 Determination of Flash Point. The flash point of a liquid shall be determined according to the methods specified in this subsection.

1.7.4.1 The flash point of a liquid having a viscosity below 5.5 centiStokes at 40°C (104°F) or below 9.5 centiStokes at 25°C (77°F) shall be determined in accordance with ASTM D 56, *Standard Method of Test for Flash Point by the Tag Closed Cup Tester*.

Exception: Cut-back asphalts, liquids that tend to form a surface film, and liquids that contain suspended solids shall not be tested in accordance with ASTM D 56, even if they otherwise meet the viscosity criteria.

1.7.4.2 The flash point of a liquid having a viscosity of 5.5 centiStokes or more at 40°C (104°F) or 9.5 centiStokes or more at 25°C (77°F) or a flash point of 93.4°C (200°F) or higher shall be determined in accordance with ASTM D 93, *Standard Test Methods for Flash Point by the Pensky-Martens Closed Tester*.

1.7.4.3 As an alternative, ASTM D 3278, *Standard Method of Tests for Flash Point of Liquids by Setaflash Closed Tester*, shall be permitted to be used for paints, enamels, lacquers, varnishes, and related products and their components that have flash points between 0°C (32°F) and 110°C (230°F) and viscosities below 150 Stokes at 25°C (77°F).

1.7.4.4 As an alternative, ASTM D 3828, *Standard Test Methods for Flash Point by Small Scale Closed Tester*, shall be permitted to be used for materials other than those for which ASTM D 3278, *Standard Method of Tests for Flash Point of Liquids by Setaflash Closed Tester*, is specifically required.

1.8 Use of Other Units.

If a value for measurement given in this standard is followed by an equivalent value in other units, the first stated shall be regarded as the requirement. The given equivalent value shall be considered to be approximate.

1.9 General Requirements.

1.9.1 Storage. Liquids shall be stored in tanks in accordance with Chapter 4 or in containers, portable tanks, and intermediate bulk containers in accordance with Chapter 6.

1.9.2 Exits. Egress from buildings and areas covered by this code shall meet the requirements of NFPA 101, *Life Safety Code*.

Chapter 2 Referenced Publications

2.1 General.

The documents or portions thereof listed in this chapter are referenced within this code and shall be considered part of the requirements of this document.

2.2 NFPA Publications.

National Fire Protection Association, 1 Batterymarch Park, P.O. Box 9101, Quincy, MA 02269-9101.

NFPA 11, *Standard for Low-, Medium-, and High-Expansion Foam*, 2002 edition.

NFPA 11A, *Standard for Medium- and High-Expansion Foam Systems*, 1999 edition.

NFPA 12, *Standard on Carbon Dioxide Extinguishing Systems*, 2000 edition.

NFPA 12A, *Standard on Halon 1301 Fire Extinguishing Systems*, 1997 edition.

NFPA 13, *Standard for the Installation of Sprinkler Systems*, 2002 edition.

NFPA 14, *Standard for the Installation of Standpipe and Hose Systems*, 2003 edition.

NFPA 15, *Standard for Water Spray Fixed Systems for Fire Protection*, 2001 edition.

NFPA 16, *Standard for the Installation of Foam-Water Sprinkler and Foam-Water Spray Systems*, 2003 edition.

NFPA 17, *Standard for Dry Chemical Extinguishing Systems*, 2002 edition.

NFPA 25, *Standard for the Inspection, Testing, and Maintenance of Water-Based Fire Protection Systems*, 2002 edition.

NFPA 30A, *Code for Motor Fuel Dispensing Facilities and Repair Garages*, 2003 edition.

NFPA 31, *Standard for the Installation of Oil-Burning Equipment*, 2001 edition.

NFPA 32, *Standard for Drycleaning Plants*, 2000 edition.

NFPA 33, *Standard for Spray Application Using Flammable or Combustible Materials*, 2003 edition.

NFPA 34, *Standard for Dipping and Coating Processes Using Flammable or Combustible Liquids*, 2003 edition.

NFPA 35, *Standard for the Manufacture of Organic Coatings*, 1999 edition.

NFPA 36, *Standard for Solvent Extraction Plants*, 2001 edition.

NFPA 37, *Standard for the Installation and Use of Stationary Combustion Engines and Gas Turbines*, 2002 edition.

NFPA 45, *Standard on Fire Protection for Laboratories Using Chemicals*, 2000 edition.

Copyright NFPA

NFPA 58, *Liquefied Petroleum Gas Code*, 2001 edition.

NFPA 59A, *Standard for the Production, Storage, and Handling of Liquefied Natural Gas (LNG)*, 2001 edition.

NFPA 69, *Standard on Explosion Prevention Systems*, 2002 edition.

NFPA 70, *National Electrical Code*®, 2002 edition.

NFPA 80, *Standard for Fire Doors and Fire Windows*, 1999 edition.

NFPA 85, *Boiler and Combustion Systems Hazards Code*, 2001 edition.

NFPA 90A, *Standard for the Installation of Air-Conditioning and Ventilating Systems*, 2002 edition.

NFPA 91, *Standard for Exhaust Systems for Air Conveying of Vapors, Gases, Mists, and Noncombustible Particulate Solids*, 1999 edition.

NFPA 99, *Standard for Health Care Facilities*, 2002 edition.

NFPA 101®, *Life Safety Code*®, 2003 edition.

NFPA 220, *Standard on Types of Building Construction*, 1999 edition.

NFPA 221, *Standard for Fire Walls and Fire Barrier Walls*, 2000 edition.

NFPA 230, *Standard for the Fire Protection of Storage*, 2003 edition.

NFPA 251, *Standard Methods of Tests of Fire Endurance of Building Construction and Materials*, 1999 edition.

NFPA 303, *Fire Protection Standard for Marinas and Boatyards*, 2000 edition.

NFPA 307, *Standard for the Construction and Fire Protection of Marine Terminals, Piers, and Wharves*, 2000 edition.

NFPA 505, *Fire Safety Standard for Powered Industrial Trucks Including Type Designations, Areas of Use, Conversions, Maintenance, and Operation*, 2002 edition.

NFPA 704, *Standard System for the Identification of the Hazards of Materials for Emergency Response*, 2001 edition.

2.3 Other Publications.

2.3.1 API Publications.

American Petroleum Institute, 1220 L Street, NW, Washington, DC 20005.

API Specification 12B, *Bolted Tanks for Storage of Production Liquids*, 14th edition, 1995.

API Specification 12D, *Field Welded Tanks for Storage of Production Liquids*, 10th edition, 1994.

API Specification 12F, *Shop Welded Tanks for Storage of Production Liquids*, 11th edition, 1994.

Copyright NFPA

API 620, *Recommended Rules for the Design and Construction of Large, Welded, Low-Pressure Storage Tanks*, 9th edition, 1999.

API Standard 650, *Welded Steel Tanks for Oil Storage*, 10th edition, 1998.

API Standard 2000, *Venting Atmospheric and Low-Pressure Storage Tanks*, 5th edition, 1998.

2.3.2 ASME Publications.

American Society of Mechanical Engineers, Three Park Avenue, New York, NY 10016-5990.

ASME Boiler and Pressure Vessel Code.

ASME B31, *Code for Pressure Piping*, 1998.

ASME *Code for Unfired Pressure Vessels*, 1998.

2.3.3 ASTM Publications.

American Society for Testing and Materials, 100 Barr Harbor Drive, West Conshohocken, PA 19428-2959.

ASTM A 395, *Ferritic Ductile Iron Pressure-Retaining Castings for Use at Elevated Temperatures*, 1999.

ASTM D 5, *Standard Test Method for Penetration of Bituminous Materials*, 1997.

ASTM D 56, *Standard Method of Test for Flash Point by the Tag Closed Cup Tester*, 1998.

ASTM D 86, *Standard Method of Test for Distillation of Petroleum Products*, 2000.

ASTM D 92, *Standard Test Method for Flash and Fire Points by Cleveland Open Cup*, 1998.

ASTM D 93, *Standard Test Methods for Flash Point by the Pensky-Martens Closed Tester*, 1999.

ASTM D 323, *Standard Method of Test for Vapor Pressure of Petroleum Products (Reid Method)*, 1999.

ASTM D 3278, *Standard Method of Tests for Flash Point of Liquids by Setaflash Closed Tester*, 1996.

ASTM D 3828, *Standard Test Methods for Flash Point by Small Scale Closed Tester*, 1998.

ASTM F 852, *Standard for Portable Gasoline Containers for Consumer Use*, 1999.

ASTM F 976, *Standard for Portable Kerosene Containers for Consumer Use*, 1999.

2.3.4 ATA Publication.

American Trucking Association Traffic Department, 2200 Mill Road, Alexandria, VA 22314.

National Motor Freight Classification.

Copyright NFPA

2.3.5 FMRC Publications.

Factory Mutual Research Corporation, 1151 Boston-Providence Turnpike, Norwood, MA 02062.

FMRC Class 6083, *Examination Program for Fusible Closures for Steel Drums.*

2.3.6 NRFC Publication.

National Railroad Freight Committee, 222 South Riverside Plaza, Chicago, IL 60606-5945.
Uniform Freight Classification.

2.3.7 UL Publications.

Underwriters Laboratories Inc., 333 Pfingsten Road, Northbrook, IL 60062.

UL 58, *Standard for Steel Underground Tanks for Flammable and Combustible Liquids*, 1996.

UL 80, *Standard for Steel Inside Tanks for Oil Burner Fuel*, 1996.

UL 142, *Standard for Steel Aboveground Tanks for Flammable and Combustible Liquids*, 1993.

UL 971, *Standard for Nonmetallic Underground Piping for Flammable Liquids*, 1995.

ANSI/UL 1313, *Nonmetallic Safety Cans for Petroleum Products*, 1993.

UL 1316, *Standard for Glass-Fiber Reinforced Plastic Underground Storage Tanks for Petroleum Products, Alcohols, and Alcohol-Gasoline Mixtures*, 1994.

UL 1746, *Standard for External Corrosion Protection Systems for Steel Underground Storage Tanks, Part I*, 1993.

UL 2080, *Standard for Fire Resistant Tanks for Flammable and Combustible Liquids*, 2000.

UL 2085, *Standard for Protected Aboveground Tanks for Flammable and Combustible Liquids*, 1997.

UL 2208, *Standard for Solvent Distillation Units*, 1996.

UL 2245, *Standard for Below-Grade Vaults for Flammable Liquid Storage Tanks*, 1999.

UL 2368, *Standard for Fire Exposure Testing of Intermediate Bulk Containers for Flammable and Combustible Liquids*, 2001.

2.3.8 UN Publication.

United Nations, Headquarters, New York, NY 10017.

Recommendations on the Transport of Dangerous Goods, 9th revised edition, 1995.

2.3.9 U.S. Government Publications.

U.S. Government Printing Office, Washington, DC 20402.

Copyright NFPA

Title 33, *Code of Federal Regulations*, Parts 154, 155 and 156.

Title 46, *Code of Federal Regulations*, Parts 30, 32, 35, and 39.

Title 49, *Code of Federal Regulations*, “Transportation.”

Title 49, *Code of Federal Regulations*, Part 173, Appendix H.

Chapter 3 Definitions

3.1 General.

The definitions contained in this chapter shall apply to the terms used in this code. Where terms are not included, common usage of the terms shall apply.

3.2 NFPA Official Definitions.

3.2.1* Approved. Acceptable to the authority having jurisdiction.

3.2.2* Authority Having Jurisdiction. An organization, office, or individual responsible for enforcing the requirements of a code or standard, or for approving equipment, materials, an installation, or a procedure.

3.2.3* Code. A standard that is an extensive compilation of provisions covering broad subject matter or that is suitable for adoption into law independently of other codes and standards.

3.2.4 Labeled. Equipment or materials to which has been attached a label, symbol, or other identifying mark of an organization that is acceptable to the authority having jurisdiction and concerned with product evaluation, that maintains periodic inspection of production of labeled equipment or materials, and by whose labeling the manufacturer indicates compliance with appropriate standards or performance in a specified manner.

3.2.5* Listed. Equipment, materials, or services included in a list published by an organization that is acceptable to the authority having jurisdiction and concerned with evaluation of products or services, that maintains periodic inspection of production of listed equipment or materials or periodic evaluation of services, and whose listing states that either the equipment, material, or service meets appropriate designated standards or has been tested and found suitable for a specified purpose.

3.3 General Definitions.



3.3.1 Area.

3.3.1.1 Fire Area. An area of a building separated from the remainder of the building by construction having a fire resistance of at least 1 hour and having all communicating openings properly protected by an assembly having a fire resistance rating of at least 1 hour.

3.3.1.2 Inside Liquid Storage Area. A room or building used for the storage of liquids in

containers or portable tanks, separated from other types of occupancies.

3.3.2 Barrel. A unit of volume used in the petroleum industry that is equal to 0.159 m³ (159 L or 42 gal).

3.3.3 Basement. For the purposes of this code, a story of a building or structure having one-half or more of its height below ground level and to which access for fire-fighting purposes is restricted.

3.3.4 Boiling Point. The temperature at which the vapor pressure of a liquid equals the surrounding atmospheric pressure. *(See 1.7.2.1.)*

3.3.5* Boil-Over. An event in the burning of certain oils in an open-top tank when, after a long period of quiescent burning, there is a sudden increase in fire intensity associated with expulsion of burning oil from the tank.

3.3.6 Building. A structure used or intended for supporting or sheltering any use or occupancy.

3.3.6.1 Attached Building. A building having only one common wall with another building having other types of occupancies.

3.3.6.2* Important Building. A building that is considered not expendable in an exposure fire.

3.3.6.3 Storage Tank Building. A three-dimensional space that is enclosed by a roof and a wall that covers more than one-half of the possible area of the sides of the space, is of sufficient size to allow entry by personnel, will likely limit the dissipation of heat or dispersion of vapors, and restricts access for fire fighting. *(See 4.3.4.)*

3.3.7* Container. Any vessel of 450 L (119 gal) or less capacity used for transporting or storing liquids.

3.3.7.1 Closed Container. A container as herein defined, so sealed by means of a lid or other device that neither liquid nor vapor will escape from it at ordinary temperatures.

3.3.8 Crude Petroleum. Hydrocarbon mixtures that have a flash point below 65.6°C (150°F) and that have not been processed in a refinery.

3.3.9 Cryogenic Liquid. A liquid having a boiling point lower than -101°C (-150°F) at an absolute pressure of 101 kPa (14.7 psi). [55:3.3]

3.3.10 Damage-Limiting Construction. Any set of construction elements which will act to limit damage from an explosion, including open structures, pressure relieving construction, or pressure resistant construction. These features can be used individually or in combination.

3.3.11 Distillery. A plant or that portion of a plant where liquids produced by fermentation are concentrated and where the concentrated products are also mixed, stored, or packaged.

3.3.12 Dwelling.

3.3.12.1 Multifamily Dwelling. A building that contains three or more dwelling units.

3.3.12.2 One-Family Dwelling. A building that consists solely of one dwelling unit.

Copyright NFPA

3.3.12.3 Two-Family Dwelling. A building that consists solely of two dwelling units.

3.3.13 Dwelling Unit. A single unit, providing complete, independent living facilities for one or more persons, including permanent provisions for living, sleeping, eating, cooking, and sanitation.

3.3.14 Emergency Relief Vent. An opening, construction method, or device that will automatically relieve excessive internal pressure due to an exposure fire.

3.3.15 Fire Point. The lowest temperature at which a liquid will ignite and achieve sustained burning when exposed to a test flame in accordance with ASTM D 92, *Standard Test Method for Flash and Fire Points by Cleveland Open Cup*.

3.3.16 Flash Point. The minimum temperature of a liquid at which sufficient vapor is given off to form an ignitable mixture with the air, near the surface of the liquid or within the vessel used, as determined by the appropriate test procedure and apparatus specified in 1.7.4.

3.3.17* Fugitive Emissions. Releases of flammable vapor that continuously or intermittently occur from process equipment during normal operations.

3.3.18* Hazardous Material or Hazardous Chemical. Material presenting dangers beyond the fire problems relating to flash point and boiling point.

3.3.19 Hazardous Materials Storage Locker. A movable prefabricated structure, manufactured primarily at a site other than the final location of the structure and transported completely assembled or in a ready-to-assemble package to the final location. It is intended to meet local, state, and federal requirements for outside storage of hazardous materials.

3.3.20* Hazardous Reaction or Hazardous Chemical Reaction. Reactions that result in dangers beyond the fire problems relating to flash point and boiling point of either the reactants or of the products.

3.3.21 Heat Transfer Fluid (HTF). A liquid that is used as a medium to transfer heat energy from a heater or vaporizer to a remote heat consumer (e.g., injection molding machine, oven, or dryer, or jacketed chemical reactor).

3.3.22 Hotel. A building or groups of buildings under the same management in which there are sleeping accommodations for more than 16 persons and primarily used by transients for lodging with or without meals. [**101:** 3.3]

3.3.23 Incidental Liquid Use or Storage. Use or storage as a subordinate activity to that which establishes the occupancy or area classification.

3.3.24 Liquefied Gas. A gas, other than in solution, that in a packaging under the charged pressure exists both as a liquid and a gas at a temperature of 20°C (68°F).

3.3.25 Liquid. Any material that has a fluidity greater than that of 300 penetration asphalt when tested in accordance with ASTM D 5, *Standard Method of Test for Penetration of Bituminous Materials*.

3.3.25.1 Combustible Liquid. Any liquid that has a closed-cup flash point at or above 100°F (37.8°C), as determined by the test procedures and apparatus set forth in 1.7.4. Combustible

liquids are classified as Class II or Class III as follows: (1) *Class II Liquid* — any liquid that has a flash point at or above 100°F (37.8°C) and below 140°F (60°C); (2) *Class IIIA* — any liquid that has a flash point at or above 140°F (60°C), but below 200°F (93°C); (3) *Class IIIB* — any liquid that has a flash point at or above 200°F (93°C).

3.3.25.2 Flammable Liquid. Any liquid that has a closed-cup flash point below 100°F (37.8°C), as determined by the test procedures and apparatus set forth in 1.7.4. Flammable liquids are classified as Class I as follows: *Class I Liquid* — any liquid that has a closed-cup flash point below 100°F (37.8°C) and a Reid vapor pressure not exceeding 40 psia (2068.6 mm Hg) at 100°F (37.8°C), as determined by ASTM D 323, *Standard Method of Test for Vapor Pressure of Petroleum Products (Reid Method)*. Class I liquids are further classified as follows: (1) Class IA liquids — those liquids that have flash points below 73°F (22.8°C) and boiling points below 100°F (37.8°C); (2) Class IB liquids — those liquids that have flash points below 73°F (22.8°C) and boiling points at or above 100°F (37.8°C); (3) Class IC liquids — those liquids that have flash points at or above 73°F (22.8°C), but below 100°F (37.8°C).

3.3.25.3 Stable Liquid. Any liquid not defined as unstable.

3.3.25.4 Unstable Liquid. A liquid that, in the pure state or as commercially produced or transported, will vigorously polymerize, decompose, undergo condensation reaction, or become self-reactive under conditions of shock, pressure, or temperature.

3.3.25.5* Water-Miscible Liquid. A liquid that mixes in all proportions with water without the use of chemical additives, such as emulsifying agents.

3.3.26 Liquid Warehouse. See 3.3.49.2.

3.3.27 Occupancy.

3.3.27.1 Assembly Occupancy. An occupancy (1) used for a gathering of 50 or more persons for deliberation, worship, entertainment, eating, drinking, amusement, awaiting transportation, or similar uses; or (2) used as a special amusement building, regardless of occupant load. [1:3.3]

3.3.27.2 Educational Occupancy. An occupancy used for educational purposes through the twelfth grade by six or more persons for four or more hours per day or more than 12 hours per week. [45:1.4]

3.3.27.3 Institutional Occupancy. A building or structure or any portion thereof used by persons who are harbored or detained to receive medical, charitable, or other care or treatment or by persons involuntarily detained.

3.3.27.4 Mercantile Occupancy. An occupancy used for the display and sale of merchandise. [101:3.3]

3.3.27.5 Office Occupancy. A building or structure or any portion thereof used for the transaction of business or the rendering or receiving of professional services.

3.3.28* Occupancy Classification. The system of defining the predominant operating characteristic of a portion of a building or plant for purposes of applying relevant sections of

this code.

3.3.28.1 Outdoor Occupancy Classification. Similar to occupancy classification, except that it applies to outdoor operations not enclosed in a building or shelter.

3.3.29 Operating Unit (Vessel) or Process Unit (Vessel). The equipment in which a unit operation or unit process is conducted. (*See also definition 3.3.42, Unit Operation or Unit Process.*)

3.3.30 Operations. A general term that includes, but is not limited to, the use, transfer, storage, and processing of liquids.

3.3.31* Pier. A structure, usually of greater length than width and projecting from the shore into a body of water with direct access from land, that can be either open deck or provided with a superstructure. [307:2.1]

3.3.32 Plant.

3.3.32.1 Bulk Plant or Terminal. That portion of a property where liquids are received by tank vessel, pipelines, tank car, or tank vehicle and are stored or blended in bulk for the purpose of distributing such liquids by tank vessel, pipeline, tank car, tank vehicle, portable tank, or container.

3.3.32.2 Chemical Plant. A large integrated plant or that portion of such a plant, other than a refinery or distillery, where liquids are produced by chemical reactions or used in chemical reactions.

3.3.33 Pressure Vessel. A container or other component designed in accordance with the *ASME Boiler and Pressure Vessel Code*. [52:3.3]

3.3.34* Process or Processing. An integrated sequence of operations.

3.3.35 Protection for Exposures. Fire protection for structures on property adjacent to liquid storage that is provided by (1) a public fire department or (2) a private fire brigade maintained on the property adjacent to the liquid storage, either of which is capable of providing cooling water streams to protect the property adjacent to the liquid storage.

3.3.36 Refinery. A plant in which flammable or combustible liquids are produced on a commercial scale from crude petroleum, natural gasoline, or other hydrocarbon sources.

3.3.37 Room.

3.3.37.1 Cutoff Room. A room within a building and having at least one exterior wall.

3.3.37.2 Inside Room. A room totally enclosed within a building and having no exterior walls.

3.3.38 Safety Can. A listed container, of not more than 20 L (5.3 gal) capacity, having a spring-closing lid and spout cover and so designed that it will safely relieve internal pressure when subjected to fire exposure.

3.3.39 Solvent Distillation Unit. An appliance that distills a flammable or combustible liquid to remove contaminants and recover the liquid.

3.3.40 Staging. Temporary storage in a process area of liquids in containers, intermediate bulk containers, and portable tanks.

3.3.41 Tank.

3.3.41.1 Aboveground Tank. A tank that is installed above grade, at grade, or below grade without backfill.

3.3.41.1.1 Protected Aboveground Tank. An aboveground storage tank that is listed in accordance with UL 2085, *Standard for Protected Aboveground Tanks for Flammable and Combustible Liquids*, or an equivalent test procedure that consists of a primary tank provided with protection from physical damage and fire-resistive protection from exposure to a high-intensity liquid pool fire.

3.3.41.2* Atmospheric Tank. A storage tank that has been designed to operate at pressures from atmospheric through a gauge pressure of 6.9 kPa (1.0 psig) (i.e., 760 mm Hg through 812 mm Hg) measured at the top of the tank.

•

3.3.41.3 Low-Pressure Tank. A storage tank designed to withstand an internal pressure above a gauge pressure of 6.9 kPa (1.0 psig) but not more than 103.4 kPa (15 psig or 1 bar gauge) measured at the top of the tank.

3.3.41.4 Portable Tank. Any closed vessel having a liquid capacity over 230 L (60 gal) and not intended for fixed installation. This includes intermediate bulk containers (IBCs) as defined and regulated by the U.S. Department of Transportation.

3.3.41.5 Secondary Containment Tank. A tank that has an inner and outer wall with an interstitial space (annulus) between the walls and that has a means for monitoring the interstitial space for a leak.

3.3.41.6 Storage Tank. Any vessel having a liquid capacity that exceeds 230 L (60 gal), is intended for fixed installation, and is not used for processing.

3.3.42 Unit Operation or Unit Process. A segment of a physical or chemical process that might or might not be integrated with other segments to constitute the manufacturing sequence.

3.3.43 Vapor Pressure. The pressure, measured in pounds per square inch, absolute (psia), exerted by a liquid, as determined by ASTM D 323, *Standard Method of Test for Vapor Pressure of Petroleum Products (Reid Method)*.

3.3.44 Vapor Processing Equipment. Those components of a vapor processing system designed to process vapors or liquids captured during transfer or filling operations.

3.3.45* Vapor Processing System. A system designed to capture and process vapors displaced during transfer or filling operations by use of mechanical or chemical means.

3.3.46* Vapor Recovery System. A system designed to capture and retain, without processing, vapors displaced during transfer or filling operations.

3.3.47 Vault. An enclosure consisting of four walls, a floor, and a top for the purpose of

containing a liquid storage tank and not intended to be occupied by personnel other than for inspection, repair, or maintenance of the vault, the storage tank, or related equipment.

3.3.48* Ventilation. As specified in this code, movement of air that is provided for the prevention of fire and explosion.

3.3.49* Warehouse.

3.3.49.1 General-Purpose Warehouse. A separate, detached building or portion of a building used only for warehousing-type operations.

3.3.49.2 Liquid Warehouse. A separate, detached building or attached building used for warehousing-type operations for liquids.

3.3.50* Wharf. A structure at the shoreline, having a platform built along and parallel to a body of water with either open deck or provided with a superstructure.

Chapter 4 Tank Storage

4.1 General.

4.1.1 Scope. This chapter shall apply to the following:

- (1) The storage of flammable and combustible liquids, as defined in 1.7.3, in fixed aboveground and underground tanks
- (2) The storage of flammable and combustible liquids in portable tanks and bulk containers whose capacity exceeds 3000 L (793 gal)
- (3) The design, installation, testing, operation, and maintenance of such tanks, portable tanks, and bulk containers

4.1.2 Applicability. (Reserved)

4.1.3 Special Terms.

4.1.3.1 Floating Roof Tank. For the purposes of this chapter, a floating roof tank shall mean a tank that incorporates one of the following designs:

- (1) A closed-top pontoon or double-deck metal floating roof in an open-top tank constructed in accordance with API Standard 650, *Welded Steel Tanks for Oil Storage*
- (2) A fixed metal roof with ventilation at the top and roof eaves constructed in accordance with API 650 and containing a closed-top pontoon or double-deck metal floating roof meeting the requirements of API 650
- (3) A fixed metal roof with ventilation at the top and roof eaves constructed in accordance with API 650 and containing a metal floating cover supported by liquidtight metal floating devices that provide sufficient buoyancy to prevent the liquid surface from being exposed when half of the flotation is lost

4.1.3.1.1 An internal metal floating pan, roof, or cover that does not meet this definition or one that uses plastic foam (except for seals) for flotation, even if encapsulated in metal or fiberglass, shall be considered a fixed roof tank.

4.2 Design and Construction of Tanks.

4.2.1 General Requirements. Tanks shall be permitted to be of any shape, size, or type consistent with recognized engineering standards. Metal tanks shall be welded, riveted and caulked, or bolted, or constructed using a combination of these methods.

4.2.1.1 Tanks designed and intended for aboveground use shall not be used as underground tanks.

4.2.1.2 Tanks designed and intended for underground use shall not be used as aboveground tanks.

4.2.2 Materials of Construction. Tanks shall be designed and built in accordance with recognized engineering standards for the material of construction being used. Tanks shall be of steel or other approved noncombustible material, with the following limitations and exceptions:

- (1) The materials of construction for tanks and their appurtenances shall be compatible with the liquid to be stored. In case of doubt about the properties of the liquid to be stored, the supplier, producer of the liquid, or other competent authority shall be consulted.
- (2) Tanks shall be permitted to be constructed of combustible materials when approved by the authority having jurisdiction. Tanks constructed of combustible materials shall be limited to any of the following:
 - (a) Underground installation
 - (b) Use where required by the properties of the liquid stored
 - (c) Aboveground storage of Class IIIB liquids in areas not exposed to a spill or leak of Class I or Class II liquid
 - (d) Storage of Class IIIB liquids inside a building protected by an approved automatic fire-extinguishing system
- (3) Unlined concrete tanks shall be permitted to be used for storing liquids that have a gravity of 40° API or heavier. Concrete tanks with special linings shall be permitted to be used for other liquids provided they are designed and constructed in accordance with recognized engineering standards.
- (4) Tanks shall be permitted to have combustible or noncombustible linings. The choice of the lining material and its required thickness shall depend on the properties of the liquid to be stored.
- (5) Special engineering consideration shall be required if the specific gravity of the liquid to be stored exceeds that of water or if the tank is designed to contain liquids at a liquid temperature below -17.8°C (0°F).

4.2.3 Design Standards.

4.2.3.1 Design Standards for Atmospheric Tanks.

4.2.3.1.1 Atmospheric tanks, including those incorporating secondary containment, shall be designed and constructed in accordance with recognized engineering standards or approved equivalents. Atmospheric tanks that meet any of the following standards shall be deemed as meeting the requirements of 4.2.3.1:

- (1) UL 58, *Standard for Steel Underground Tanks for Flammable and Combustible Liquids*; UL 80, *Standard for Steel Inside Tanks for Oil Burner Fuel*; UL 142, *Standard for Steel Aboveground Tanks for Flammable and Combustible Liquids*; UL 2080, *Standard for Fire Resistant Tanks for Flammable and Combustible Liquids*; or UL 2085, *Standard for Protected Aboveground Tanks for Flammable and Combustible Liquids*
- (2) API Specification 12B, *Bolted Tanks for Storage of Production Liquids*; API Specification 12D, *Field Welded Tanks for Storage of Production Liquids*; API Specification 12F, *Shop Welded Tanks for Storage of Production Liquids*; or API Standard 650, *Welded Steel Tanks for Oil Storage*
- (3) UL 1316, *Standard for Glass-Fiber Reinforced Plastic Underground Storage Tanks for Petroleum Products, Alcohols, and Alcohol-Gasoline Mixtures*
- (4) UL 1746, *Standard for External Corrosion Protection Systems for Steel Underground Storage Tanks*

4.2.3.1.2 Atmospheric tanks designed and constructed in accordance with Appendix F of API Standard 650, *Welded Steel Tanks for Oil Storage*, shall be permitted to operate at pressures from atmospheric to a gauge pressure of 6.9 kPa (1.0 psig). All other tanks shall be limited to operation from atmospheric to a gauge pressure of 3.5 kPa (0.5 psig).

Exception No. 1: Atmospheric tanks that are not designed and constructed in accordance with Appendix F of API Standard 650, Welded Steel Tanks for Oil Storage, shall be permitted to operate at pressures from atmospheric to a gauge pressure of 6.9 kPa (1.0 psig) only if an engineering analysis is performed to determine that the tank can withstand the elevated pressure.

Exception No. 2: Horizontal cylindrical and rectangular tanks built according to any of the standards specified in 4.2.3.1.1 shall be permitted to operate at pressures from atmospheric to a gauge pressure of 6.9 kPa (1.0 psig) and shall be limited to a gauge pressure of 17 kPa (2.5 psig) under emergency venting conditions.

4.2.3.1.3 Low-pressure tanks and pressure vessels shall be permitted to be used as atmospheric tanks.

4.2.3.1.4 Atmospheric tanks shall not be used to store a liquid at a temperature at or above its boiling point.

4.2.3.2 Design Standards for Low-Pressure Tanks.

4.2.3.2.1 Low-pressure tanks shall be designed and constructed in accordance with

recognized engineering standards or approved equivalents. Low-pressure tanks that meet either of the following standards shall be deemed as meeting the requirements of 4.2.3.2:

- (1) API 620, *Recommended Rules for the Design and Construction of Large, Welded, Low-Pressure Storage Tanks*
- (2) ASME *Code for Unfired Pressure Vessels*, Section VIII, Division 1

4.2.3.2.2 Low-pressure tanks shall not be operated above their design pressures.

4.2.3.2.3 Pressure vessels shall be permitted to be used as low-pressure tanks.

4.2.3.3 Design Standards for Pressure Vessels.

4.2.3.3.1 Tanks with storage pressures above 1 bar gauge (15 psig) shall be designed and constructed in accordance with recognized engineering standards or approved equivalents. Pressure vessels that meet any of the following standards shall be deemed as meeting the requirements of 4.2.3.3:

- (1) Fired pressure vessels shall be designed and constructed in accordance with Section I (Power Boilers), or Section VIII, Division 1 or Division 2 (Pressure Vessels), as applicable, of the ASME *Boiler and Pressure Vessel Code*.
- (2) Unfired pressure vessels shall be designed and constructed in accordance with Section VIII, Division 1 or Division 2, of the ASME *Boiler and Pressure Vessel Code*.

4.2.3.3.2* Pressure vessels that do not meet the requirements of 4.2.3.3.1(1) or 4.2.3.3.1(2) shall be permitted to be used provided approval has been obtained from the state or other governmental jurisdiction in which they are to be used.

4.2.3.3.3 Pressure vessels shall not be operated above their design pressures. The normal operating pressure of the vessel shall not exceed the design pressure of the vessel.

4.2.4 Design of Tank Supports.

4.2.4.1* Supports for tanks shall be designed and constructed in accordance with recognized engineering standards or approved equivalents.

4.2.4.2 Tanks shall be supported in a manner that prevents excessive concentration of loads on the supported portion of the shell.

4.2.4.3 In areas subject to earthquakes, tank supports and connections shall be designed to resist damage as a result of such shocks.

4.2.5 Design of Tank Vents.

4.2.5.1 Normal Venting for Tanks.

4.2.5.1.1 Atmospheric storage tanks shall be adequately vented to prevent the development of vacuum or pressure that can distort the roof of a cone roof tank or that exceeds the design pressure of other atmospheric tanks when filling or emptying the tank or because of atmospheric temperature changes.

4.2.5.1.2 Normal vents shall be sized in accordance with either API Standard 2000, *Venting Atmospheric and Low-Pressure Storage Tanks*, or another accepted standard. Alternatively, the normal vent shall be at least as large as the largest filling or withdrawal connection but in no case shall it be less than 32 mm (1.25 in.) nominal inside diameter.

4.2.5.1.3 Low-pressure tanks and pressure vessels shall be adequately vented to prevent the development of pressure or vacuum that exceeds the design pressure of the tank or vessel when filling or emptying the tank or vessel or because of atmospheric temperature changes. Means shall also be provided to prevent overpressure from any pump discharging into the tank or vessel when the pump discharge pressure can exceed the design pressure of the tank or vessel.

4.2.5.1.4 If any tank or pressure vessel has more than one fill or withdrawal connection and simultaneous filling or withdrawal can be made, the vent size shall be based on the maximum anticipated simultaneous flow.

4.2.5.1.5 For tanks equipped with vents that permit pressures to exceed a gauge pressure of 17 kPa (2.5 psig) and for low- pressure tanks and for pressure vessels, the outlet of all vents and vent drains shall be arranged to discharge in a manner that prevents localized overheating of or flame impingement on any part of the tank, if vapors from the vents are ignited.

4.2.5.1.6 Tanks and pressure vessels that store Class IA liquids shall be equipped with venting devices that are normally closed except when venting under pressure or vacuum conditions.

4.2.5.1.7 Tanks and pressure vessels that store Class IB and Class IC liquids shall be equipped with venting devices or with listed flame arrestors. When used, vent devices shall be normally closed except when venting under pressure or vacuum conditions.

4.2.5.1.8 Tanks of 475 m³ (126,000 gal or 3000 bbl) capacity or less that store crude petroleum in crude-producing areas and outside aboveground atmospheric tanks of less than 3785 L (1000 gal) capacity that contain other than Class IA liquids shall be permitted to have open vents. (*See also Exception to 4.2.5.2.1.*)

4.2.5.1.9* Flame arrestors or venting devices required in 4.2.5.1.6 and 4.2.5.1.7 shall be permitted to be omitted on tanks that store Class IB or Class IC liquids where conditions are such that their use can, in case of obstruction, result in damage to the tank.

4.2.5.2 Emergency Relief Venting for Fire Exposure for Aboveground Tanks.

4.2.5.2.1 Every aboveground storage tank shall have emergency relief venting in the form of construction or a device or devices that will relieve excessive internal pressure caused by an exposure fire. This requirement shall also apply to each compartment of a compartmented tank, the interstitial space (annulus) of a secondary containment-type tank, and the enclosed space of tanks of closed-top dike construction. This requirement shall also apply to spaces or enclosed volumes, such as those intended for insulation, membranes, or weather shields, that can contain liquid because of a leak from the primary vessel and can inhibit venting during fire exposure. The insulation, membrane, or weather shield shall not interfere with emergency

venting.

Exception: Tanks storing Class IIIB liquids that are larger than 45,400 L (45.4 m³ or 12,000 gal or 285 bbl) capacity and are not within the diked area or the drainage path of tanks storing Class I or Class II liquids do not need to meet this requirement.

4.2.5.2.2 For vertical tanks, the emergency relief venting construction referred to in 4.2.5.2.1 shall be permitted to be a floating roof, a lifter roof, a weak roof-to-shell seam, or another approved pressure-relieving construction. If used, a weak roof-to-shell seam shall be constructed to fail preferential to any other seam and shall be designed in accordance with API Standard 650, *Welded Steel Tanks for Oil Storage*, or UL 142, *Standard for Steel Aboveground Tanks for Flammable and Combustible Liquids*.

4.2.5.2.3* Where entire dependence for emergency relief venting is placed upon pressure-relieving devices, the total venting capacity of both normal and emergency vents shall be sufficient to prevent rupture of the shell or bottom of a vertical tank or of the shell or heads of a horizontal tank. If unstable liquids are stored, the effects of heat or gas resulting from polymerization, decomposition, condensation, or self-reactivity shall be taken into account. If two-phase flow is anticipated during emergency venting, an engineering evaluation shall be conducted in order to properly size the pressure-relieving devices. The total emergency relief venting capacity of both normal and emergency venting devices shall be not less than that determined in Table 4.2.5.2.3. (*See Annex B for the square footage of typical tank sizes.*)

Table 4.2.5.2.3 Wetted Area Versus Cubic Feet Free Air per Hour (CFH) [14.7 psia and 60°F (101.3 kPa and 15.6°C)]

ft ²	CFH	ft ²	CFH	ft ²	CFH
20	21,100	160	168,000	900	493,000
30	31,600	180	190,000	1,000	524,000
40	42,100	200	211,000	1,200	557,000
50	52,700	250	239,000	1,400	587,000
60	63,200	300	265,000	1,600	614,000
70	73,700	350	288,000	1,800	639,000
80	84,200	400	312,000	2,000	662,000
90	94,800	500	354,000	2,400	704,000
100	105,000	600	392,000	2,800	742,000
120	126,000	700	428,000	and over	
140	147,000	800	462,000		

Notes:

(1) For SI units, 10 ft² = 0.93 m²; 36 ft³ = 1.0 m³.

(2) Interpolation should be used for intermediate values not specified in the table.

Exception: As provided for in 4.2.5.2.5 and 4.2.5.2.6.

(A) The following requirements shall also apply:

Copyright NFPA

- (1) Emergency relief vent devices shall be vaportight and shall be permitted to be any one of the following:
 - (a) Self-closing manway cover
 - (b) Manway cover provided with long bolts that permit the cover to lift under internal pressure
 - (c) Additional or larger relief valve or valves
- (2) The wetted area of the tank shall be calculated on the basis of 55 percent of the total exposed area of a sphere or spheroid, 75 percent of the total exposed area of a horizontal tank, 100 percent of the exposed shell and floor area of a rectangular tank, but excluding the top surface of the tank, and the first 9 m (30 ft) above grade of the exposed shell area of a vertical tank.

4.2.5.2.4* The total emergency relief venting capacity for tanks and storage vessels designed to operate at pressures above a gauge pressure of 6.9 kPa (1.0 psig) shall be not less than that determined in Table 4.2.5.2.3.

Exception: When the exposed wetted area of the tank is greater than 260 m² (2800 ft²), the total emergency relief venting capacity shall be not less than that determined in Table 4.2.5.2.4 or shall be not less than that calculated by the following formula:

$$CFH = 1107(A)^{0.82}$$

where:

CFH = venting capacity requirement (ft³ of free air per hour)

A = exposed wetted surface (ft²)

Table 4.2.5.2.4 Wetted Area over 2800 ft² (260 m²) and Pressures over 1 psig (gauge pressure of 6.9 kPa)

ft ²	CFH	ft ²	CFH
2,800	742,000	9,000	1,930,000
3,000	786,000	10,000	2,110,000
3,500	892,000	15,000	2,940,000
4,000	995,000	20,000	3,720,000
4,500	1,100,000	25,000	4,470,000
5,000	1,250,000	30,000	5,190,000
6,000	1,390,000	35,000	5,900,000
7,000	1,570,000	40,000	6,570,000
8,000	1,760,000		

Note: For SI units, 10 ft² = 0.93 m²; 36 ft³ = 1.0 m³.

4.2.5.2.5 The total emergency relief venting capacity for any specific stable liquid shall be permitted to be determined by the following formula:

Copyright NFPA

$$CFH = V \frac{1337}{L\sqrt{M}}$$

where:

V = ft³ of free air per hour (CFH) value from Table 4.2.5.2.3

L = latent heat of vaporization of specific liquid (Btu/lb)

M = molecular weight of specific liquids

4.2.5.2.6* For tanks containing stable liquids, the required emergency relief venting capacity determined by 4.2.5.2.3, 4.2.5.2.4, or 4.2.5.2.5 shall be permitted to be multiplied by one of the following reduction factors when protection is provided as indicated. Only one of the following factors shall be used for any one tank:

- (1) A reduction factor of 0.5 shall be allowed for tanks with wetted area greater than 19 m² (200 ft²) that are provided with drainage that meets the requirements of 4.3.2.3.1.
- (2) A reduction factor of 0.3 shall be allowed for tanks that are protected with a water spray system that meets the requirements of NFPA 15, *Standard for Water Spray Fixed Systems for Fire Protection*, and that are provided with drainage that meets the requirements of 4.3.2.3.1.
- (3) A reduction factor of 0.3 shall be allowed for tanks that are protected with an automatically actuated water spray system that meets the requirements of NFPA 15, *Standard for Water Spray Fixed Systems for Fire Protection*.
- (4) A reduction factor of 0.3 shall be allowed for tanks protected with insulation that meets the requirements of 4.2.5.2.7.
- (5) A reduction factor of 0.15 shall be allowed for tanks that are protected with a water spray system that meets the requirements of NFPA 15, *Standard for Water Spray Fixed Systems for Fire Protection*, and tanks that have insulation that meets the requirements of 4.2.5.2.7.

Exception No. 1: Where water-miscible liquids whose heats of combustion and rates of burning are equal to or less than those of ethyl alcohol (ethanol) are stored, processed, or handled and where there is no potential fire exposure from liquids other than these liquids, the emergency relief venting capacity shall be permitted to be reduced by an additional 50 percent. Drainage shall not be required to obtain this reduction. In no case shall the factors in 4.2.5.2.6(1) through 4.2.5.2.6(5) be reduced to less than 0.15.

Exception No. 2: Where liquids that are not water-miscible and whose heats of combustion and rates of burning are equal to or less than those of ethyl alcohol (ethanol) are stored, processed, or handled and where there is no potential fire exposure from liquids other than these liquids, the emergency relief venting capacity determined by 4.2.5.2.6(1) or 4.2.5.2.6(3) shall be permitted to be reduced by an additional 50 percent. No further reduction shall be allowed for protection by means of water spray. Drainage shall not be required to obtain this reduction. In no case shall the factors in 4.2.5.2.6(1) through 4.2.5.2.6(5) be reduced to less than 0.15.

4.2.5.2.7 Insulation for which credit is taken in 4.2.5.2.6 shall meet the following performance criteria:

- (1) The insulation shall remain in place under fire exposure conditions.
- (2) The insulation shall withstand dislodgment when subjected to hose stream impingement during fire exposure.

Exception: This requirement shall not apply where use of solid hose streams is not contemplated or would not be practical.

- (3) The insulation shall maintain a maximum conductance value of 4.0 Btu per hr per ft² per degree Fahrenheit (Btu/hr/ft²/°F) when the outer insulation jacket or cover is at a temperature of 904°C (1660°F) and when the mean temperature of the insulation is 538°C (1000°F).

4.2.5.2.8 The outlets of all vents and vent drains on tanks equipped with emergency relief venting that permits pressures to exceed a gauge pressure of 17 kPa (2.5 psig) shall be arranged to discharge so that localized overheating of or flame impingement on any part of the tank will not occur if vapors from the vents are ignited.

4.2.5.2.9 Each commercial tank venting device shall have stamped on it the start-to-open pressure, the pressure at which the valve reaches the full open position, and the flow capacity at the latter pressure. If the start-to-open pressure is less than a gauge pressure of 17 kPa (2.5 psig) and the pressure at the full open position is greater than a gauge pressure of 17 kPa (2.5 psig), the flow capacity at a gauge pressure of 17 kPa (2.5 psig) shall also be stamped on the venting device. The flow capacity shall be expressed in cubic feet per hour of air at 15.6°C (60°F) and 1 bar (14.7 psia or 760 mm Hg).

4.2.5.2.9.1 The flow capacity of tank venting devices less than 200 mm (8 in.) in nominal pipe size shall be determined by actual test. These tests shall be permitted to be conducted by a qualified, impartial outside agency or by the manufacturer if certified by a qualified, impartial observer.

4.2.5.2.9.2* The flow capacity of tank venting devices equal to or greater than 200 mm (8 in.) nominal pipe size, including manway covers with long bolts, shall be determined by test or by calculation. If determined by calculation, the opening pressure shall be measured by test, the calculation shall be based on a flow coefficient of 0.5 applied to the rated orifice, the rating pressure and corresponding free orifice area shall be stated, and the word *calculated* shall appear on the nameplate.

4.2.5.2.10* Extension of Emergency Vent Piping. Piping to or from approved emergency vent devices for atmospheric and low-pressure tanks shall be sized to provide emergency vent flows that limit the back pressure to less than the maximum pressure permitted by the design of the tank. Piping to or from approved emergency vent devices for pressure vessels shall be sized in accordance with the ASME *Boiler and Pressure Vessel Code*.

4.2.5.3* Normal Venting for Underground Storage Tanks. Tank venting systems shall be provided with sufficient capacity to prevent blowback of vapor or liquid at the fill opening while the tank is being filled. Vent pipes shall be sized in accordance with Table 4.2.5.3, but

shall not be less than 32 mm (1.25 in.) nominal inside diameter. Where tank venting devices are installed in vent lines, their flow capacities shall be determined in accordance with 4.2.5.2.9.

Table 4.2.5.3 Vent Line Diameters in Inches

Maximum Flow (gpm)	Pipe Length [†]		
	50 ft	100 ft	200 ft
100	1¼	1¼	1¼
200	1¼	1¼	1¼
300	1¼	1¼	1½
400	1¼	1½	2
500	1½	1½	2
600	1½	2	2
700	2	2	2
800	2	2	3
900	2	2	3
1000	2	2	3

Note: For SI units, 1 in. = 25 mm; 1 ft = 0.3 m; 1 gal = 3.8 L.

[†]Vent lines stated length pipe plus 7 ells.

4.2.5.4 Vent Piping. Piping for normal and emergency relief venting shall be designed in accordance with Chapter 5.

4.2.6* Design of Storage Tank System Corrosion Protection. Metal used to fabricate the tank shall be thick enough to compensate for internal corrosion expected during the design life of the tank or other approved means of corrosion protection shall be provided.

4.2.6.1 External Corrosion Protection for Underground Tanks.

4.2.6.1.1 Underground tanks and their piping shall be protected by either of the following:

- (1)* A properly engineered, installed, and maintained cathodic protection system in accordance with recognized engineering standards of design
- (2)* Approved or listed corrosion-resistant materials or systems

4.2.6.1.2* Selection of the type of protection to be employed shall be based upon the corrosion history of the area and the judgment of a qualified engineer. The authority having jurisdiction shall be permitted to waive the requirements for corrosion protection where evidence is provided that such protection is not necessary.

4.2.6.2 Internal Corrosion Protection for All Tanks. Where tanks are not designed in accordance with 4.2.6, or with standards of the American Petroleum Institute, American Society of Mechanical Engineers, or the Underwriters Laboratories Inc. or if corrosion is anticipated beyond that provided for in the design formulas or standards used, additional metal thickness or suitable protective coatings or linings shall be provided to compensate for the corrosion loss expected during the design life of the tank.

4.2.7 Vaults for Aboveground Tanks.

4.2.7.1 Scope. Subsection 4.2.7 shall apply to installation of aboveground tanks in vaults and design and installation of such vaults.

4.2.7.2 General. Aboveground tanks shall be permitted to be installed in vaults that meet the requirements of 4.2.7. Except as modified by the provisions of 4.2.7, vaults shall meet all other applicable provisions of this code. Vaults shall be constructed and listed in accordance with UL 2245, *Standard for Below-Grade Vaults for Flammable Liquid Storage Tanks*. Vaults shall be permitted to be either above or below grade.

4.2.7.3 Vault Design and Construction. Vaults shall be designed and constructed to meet the following requirements:

- (1) The walls and floor of the vault shall be constructed of reinforced concrete at least 150 mm (6 in.) thick.
- (2) The top of an abovegrade vault that contains a tank storing Class I flammable liquid or Class II liquid when stored at temperatures above its flash point shall be constructed of noncombustible material and shall be designed to be weaker than the walls of the vault to ensure that the thrust of any explosion occurring inside the vault is directed upward before destructive internal pressure develops within the vault. The top of an at-grade or belowgrade vault that contains a tank storing Class I flammable liquid or Class II liquid when stored at temperatures above their flash points shall be designed to relieve or contain the force of any explosion occurring inside the vault.
- (3) The top and floor of the vault and the tank foundation shall be designed to withstand all anticipated loading, including loading from vehicular traffic, where applicable.
- (4) The walls and floor of a belowgrade vault shall be designed to withstand anticipated soil and hydrostatic loading. The vault shall be liquidtight.
- (5) Adjacent vaults shall be permitted to share a common wall.
- (6) The vault enclosure shall have no openings except those necessary for access to, inspection of, and filling, emptying, and venting of the tank.
- (7) Where required, the vault shall be designed to be wind and earthquake resistant, in accordance with recognized engineering standards.
- (8) The vault shall be provided with connections to permit ventilation to dilute, disperse, and remove any vapors prior to personnel entering the vault.
- (9) The vault shall be provided with a means for personnel entry.
- (10) The vault shall be provided with an approved means to admit a fire suppression agent.

4.2.7.4 Tank Selection and Arrangement. Tanks shall be listed for aboveground use. Each tank shall be in its own vault and shall be completely enclosed by the vault. Sufficient clearance between the tank and the vault shall be provided to allow for visual inspection and maintenance of the tank and its appurtenances. Backfill shall not be permitted around the

tank.

4.2.7.5 Tank Appurtenances.

4.2.7.5.1 Vent pipes that are provided for normal tank venting shall terminate outside the vault and at least 3.6 m (12 ft) above ground level and shall meet the requirements of 5.7.1.

4.2.7.5.2 Emergency vents shall be vaportight and shall be permitted to discharge inside the vault. Long-bolt manhole covers shall not be permitted for this purpose.

4.2.7.5.3 An approved means of overfill protection shall be provided for the tanks in the vaults. The use of ball float valves shall be prohibited.

4.2.7.5.4 Fill connections for vaults installed inside buildings shall comply with 4.3.2.5.5.

4.2.7.6 Exhaust Ventilation Systems. Vaults that contain tanks storing Class I liquids shall be ventilated at a rate of not less than 0.3 m³/min per m² of floor area (1 cfm/ft²), but not less than 4 m³/min (150 cfm). Such ventilation shall operate continuously or shall be designed to operate upon activation of a vapor and liquid detection system. Failure of the exhaust airflow shall automatically shut down the dispensing system. The exhaust system shall be designed to provide air movement across all parts of the vault floor. Supply and exhaust ducts shall extend to within 75 mm (3 in.), but not more than 300 mm (12 in.), of the floor. The exhaust system shall be installed in accordance with the provisions of NFPA 91, *Standard for Exhaust Systems for Air Conveying of Vapors, Gases, Mists, and Noncombustible Particulate Solids*.

4.2.7.7 Vapor and Liquid Detection Systems.

4.2.7.7.1 The vault shall be provided with an approved vapor and liquid detection system and equipped with on-site audible and visual warning devices with battery back-up.

4.2.7.7.2 Vapor detection systems shall sound an alarm when the system detects vapors that reach or exceed 25 percent of the lower flammable limit of the liquid stored. Vapor detectors shall be located no higher than 300 mm (12 in.) above the lowest point in the vault.

4.2.7.7.3 Liquid detection systems shall sound an alarm upon detection of any liquid, including water. Liquid detectors shall be located in accordance with the manufacturer's instructions.

4.2.7.7.4 Activation of either the vapor detection system or the liquid detection system shall cause a signal to be sounded at an approved, constantly attended location within the facility serving the tanks or at an approved location.

4.2.7.8 Vault Installation. The vault shall be installed in accordance with the following requirements:

- (1) Each vault and its tank shall be anchored to resist uplifting by groundwater or flooding, including when the tank is empty.
- (2) Vaults that are not resistant to damage from the impact of a motor vehicle shall be protected by collision barriers.
- (3) Dispensing devices shall be permitted to be installed on the tops of vaults.

- (4) Means shall be provided to recover liquid from the vault. If a pump is used to meet this requirement, the pump shall not be permanently installed in the vault. Electric-powered portable pumps shall be approved for use in Class I, Division 1 locations, as defined in NFPA 70, *National Electrical Code*.
- (5) At each entry point, a warning sign indicating the need for procedures for safe entry into confined spaces shall be posted. Each entry point shall be secured against unauthorized entry and vandalism.

4.2.7.9 In lieu of the separation distance requirements given in 4.3.2.1.1, separation distances between the vault and any of the following shall be permitted to be reduced to 0 ft (0 m), as measured from the outer perimeter of the vault wall:

- (1) Any property line that is or can be built upon
- (2) The near and far sides of a public way
- (3) The nearest important building on the same property

4.2.7.10 Vaults and their required equipment shall be maintained in accordance with the construction requirements of 4.2.7.

4.2.8 Fire-Resistant Tanks. (Reserved)

4.2.9 Protected Tanks. Protected tanks shall be listed and shall be tested in accordance with UL 2085, *Standard for Protected Aboveground Tanks for Flammable and Combustible Liquids*. Protected tanks shall also meet both of the following requirements:

- (1) The construction that provides the required fire-resistive protection shall reduce the heat transferred to the primary tank and shall prevent release of liquid, failure of the primary tank, failure of the supporting structure, and impairment of venting for a period of not less than 2 hours when tested using the fire exposure specified in UL 2085.
- (2) The size of the emergency vent shall not be permitted to be reduced, as would otherwise be permitted by 4.2.5.2.6.

4.3 Installation of Tanks and Tank Appurtenances.

4.3.1 Foundations for and Anchoring of Tanks.

4.3.1.1* Tanks shall rest on the ground or on foundations made of concrete, masonry, piling, or steel. Tank foundations shall be designed to minimize the possibility of uneven settling of the tank and to minimize corrosion in any part of the tank resting on the foundation.

4.3.1.2 Where tanks are supported above their foundations, tank supports shall be installed on firm foundations. Supports for tanks storing Class I, Class II, or Class IIIA liquids shall be of concrete, masonry, or protected steel.

Exception: Single wood timber supports (not cribbing), laid horizontally, shall be permitted to be used for outside aboveground tanks if not more than 0.3 m (12 in.) high at their lowest

point.

4.3.1.3* Steel support structures or exposed piling for tanks storing Class I, Class II, or Class IIIA liquids shall be protected by materials having a fire resistance rating of not less than 2 hours.

Exception No. 1: Steel saddles do not need to be protected if less than 0.3 m (12 in.) high at their lowest point.

Exception No. 2: At the discretion of the authority having jurisdiction, water spray protection in accordance with NFPA 15, Standard for Water Spray Fixed Systems for Fire Protection, or NFPA 13, Standard for the Installation of Sprinkler Systems, or equivalent shall be permitted to be used.

4.3.1.4 Where a tank is located in an area subject to flooding, provisions shall be taken to prevent tanks, either full or empty, from floating during a rise in water level up to the established maximum flood stage.

4.3.2* Installation of Aboveground Tanks.

4.3.2.1 Location with Respect to Property Lines, Public Ways, and Important Buildings on the Same Property.

4.3.2.1.1 Tanks storing Class I, Class II, or Class IIIA stable liquids and operating at pressures not in excess of a gauge pressure of 17 kPa (2.5 psig) shall be located in accordance with Table 4.3.2.1.1(a) and Table 4.3.2.1.1(b). Where tank spacing is based on a weak roof-to-shell seam design, the user shall present evidence certifying such construction to the authority having jurisdiction upon request.

Table 4.3.2.1.1(a) Stable Liquids [Operating Pressure: Not over gauge pressure of 17 kPa (2.5 psig)]

Type of Tank	Protection	Minimum Distance (ft)	
		From Property Line that Is or Can Be Built Upon, Including the Opposite Side of a Public Way ¹	From Nearest Side of A Way or from Nearest I Building on the Same F
Floating roof	Protection for exposures ²	$\frac{1}{2} \times$ diameter of tank	$\frac{1}{6} \times$ diameter of tank
	None	Diameter of tank but need not exceed 175 ft	$\frac{1}{6} \times$ diameter of tank
Vertical with weak roof-to-shell seam	Approved foam or inerting system ³ on tanks not exceeding 150 ft in diameter ⁴	$\frac{1}{2} \times$ diameter of tank	$\frac{1}{6} \times$ diameter of tank
	Protection for exposures ²	Diameter of tank	$\frac{1}{3} \times$ diameter of tank
	None	$2 \times$ diameter of tank but need not exceed 350 ft	$\frac{1}{3} \times$ diameter of tank

Table 4.3.2.1.1(a) Stable Liquids [Operating Pressure: Not over gauge pressure of 17 kpsi]

Type of Tank	Protection	Minimum Distance (ft)	
		From Property Line that Is or Can Be Built Upon, Including the Opposite Side of a Public Way ¹	From Nearest Side of A Way or from Nearest Building on the Same F
Horizontal and vertical tanks with emergency relief venting to limit pressures to 2.5 psig (gauge pressure of 17 kPa)	Approved inerting system ² on the tank or approved foam system on vertical tanks	$\frac{1}{2} \times$ Table 4.3.2.1.1(b) value	$\frac{1}{2} \times$ Table 4.3.2.1.1(b) value
	Protection for exposures ²	Table 4.3.2.1.1(b) value	Table 4.3.2.1.1(b) value
	None	$2 \times$ Table 4.3.2.1.1(b) value	Table 4.3.2.1.1(b) value
Protected aboveground tank	None	$\frac{1}{2} \times$ Table 4.3.2.1.1(b) value	$\frac{1}{2} \times$ Table 4.3.2.1.1(b) value

Note: For SI units, 1 ft = 0.3 m.

¹The minimum distance shall not be less than 5 ft.

²See definition 3.3.35, Protection for Exposures.

³See NFPA 69, *Standard on Explosion Prevention Systems*.

⁴For tanks over 45 m (150 ft) in diameter, use “Protection for Exposures” or “None,” as applicable.

Table 4.3.2.1.1(b) Reference Table for Use in Tables 4.3.2.1.1(a), 4.3.2.1.2, and 4.3.2.1.4

Tank Capacity (gal)	Minimum Distance (ft)	
	From Property Line that Is or Can Be Built Upon, Including the Opposite Side of a Public Way	From Nearest Side of Any Public Way or from Nearest Important Building on the Same Property
275 or less	5	5
276 to 750	10	5
751 to 12,000	15	5
12,001 to 30,000	20	5
30,001 to 50,000	30	10
50,001 to 100,000	50	15
100,001 to 500,000	80	25
500,001 to 1,000,000	100	35
1,000,001 to 2,000,000	135	45
2,000,001 to 3,000,000	165	55
3,000,001 or more	175	60

Note: For SI units, 1 ft = 0.3 m; 1 gal = 3.8 L.

Exception: Vertical tanks with weak roof-to-shell seams (see 4.2.5.2.2) that store Class IIIA

liquids shall be permitted to be located at one-half the distances specified in Table 4.3.2.1.1(a), provided the tanks are not within the same diked area as, or within the drainage path of, a tank storing a Class I or Class II liquid.

4.3.2.1.2 Tanks storing Class I, Class II, or Class IIIA stable liquids and operating at pressures that exceed a gauge pressure of 17 kPa (gauge pressure) (2.5 psig), or are equipped with emergency venting that will permit pressures to exceed a gauge pressure of 17 kPa (2.5 psig), shall be located in accordance with Table 4.3.2.1.2 and Table 4.3.2.1.1(b).

Table 4.3.2.1.2 Stable Liquids [Operating Pressure: Greater than gau

Type of Tank	Protection	From Property Line that Is c Upon, Including the Oppo Public Way
Any type	Protection for exposures [†]	1½ × Table 4.3.2.1.1(b) value less than 25 ft
	None	3 × Table 4.3.2.1.1(b) value bu less than 50 ft

Note: For SI units, 1 ft = 0.3 m.

[†]See definition 3.3.35, Protection for Exposures.

4.3.2.1.3 Tanks storing liquids with boil-over characteristics shall be located in accordance with Table 4.3.2.1.3. Liquids with boil-over characteristics shall not be stored in fixed roof tanks larger than 45 m (150 ft) in diameter, unless an approved inerting system is provided on the tank.

Table 4.3.2.1.3 Boil-Over Liquids

Type of Tank	Protection	From Property Line th Built Upon, Including tl of a Public W
Floating roof [see Table 4.3.2.1.1(a)]	Protection for exposures ²	½ × diameter of tank
	None	Diameter of tank
Fixed roof	Approved foam or inerting system ³	Diameter of tank
	Protection for exposures ²	2 × diameter of tank
	None	4 × diameter of tank but : 350 ft

Note: For SI units, 1 ft = 0.3 m.

¹The minimum distance shall not be less than 5 ft.

²See definition 3.3.35, Protection for Exposures.

³See NFPA 69, *Standard on Explosion Prevention Systems*.

4.3.2.1.4 Tanks storing unstable liquids shall be located in accordance with Table 4.3.2.1.4

Type of Tank	Protection	From Property Line Built Upon, Including that of a Public Utility
--------------	------------	---

4.3.2.1.4 Tanks storing unstable liquids shall be located in accordance with Table 4.3.2.1.4 and Table 4.3.2.1.1(b).

Table 4.3.2.1.4 Unstable Liquids

Type of Tank	Protection	From Property Line Built Upon, Including that of a Public Utility
Horizontal and vertical tanks with emergency relief venting to permit pressure not in excess of a gauge pressure of 17 kPa (2.5 psig)	Tank protected with any one of the following: approved water spray, approved inerting, ¹ approved insulation and refrigeration, approved barricade	Table 4.3.2.1.1(b) value 25 ft
	Protection for exposures ²	$2\frac{1}{2} \times$ Table 4.3.2.1.1(b) value than 50 ft
	None	$5 \times$ Table 4.3.2.1.1(b) value than 100 ft
Horizontal and vertical tanks with emergency relief venting to permit pressure over a gauge pressure of 17 kPa (2.5 psig)	Tank protected with any one of the following: approved water spray, approved inerting, ¹ approved insulation and refrigeration, approved barricade	$2 \times$ Table 4.3.2.1.1(b) value than 50 ft
	Protection for exposures ²	$4 \times$ Table 4.3.2.1.1(b) value than 100 ft
	None	$8 \times$ Table 4.3.2.1.1(b) value than 150 ft

Note: For SI units, 1 ft = 0.3 m.

¹See NFPA 69, *Standard on Explosion Prevention Systems*.

²See definition 3.3.35, Protection for Exposures.

4.3.2.1.5 Tanks storing Class IIIB stable liquids shall be located in accordance with Table 4.3.2.1.5.

Table 4.3.2.1.5 Class IIIB Liquids

Tank Capacity (gal)	Minimum Distance (ft)	
	From Property Line that Is or Can Be Built Upon, Including the Opposite Side of a Public Way	From Nearest Side of Any Public Way or from Nearest Important Building on the Same Property
12,000 or less	5	5
12,001 to 30,000	10	5
30,001 to 50,000	10	10
50,001 to 100,000	15	10
100,001 or more	15	15

Note: For SI units, 1 ft = 0.3 m; 1 gal = 3.8 L.

Exception: If located within the same diked area as, or within the drainage path of, a tank storing a Class I or Class II liquid, the tank storing Class IIIB liquid shall be located in accordance with 4.3.2.1.1.

4.3.2.1.6 Where two tank properties of diverse ownership have a common boundary, the authority having jurisdiction shall be permitted, with the written consent of the owners of the two properties, to substitute the distances provided in 4.3.2.2 for the minimum distances set forth in 4.3.2.1.

4.3.2.1.7 Where end failure of a horizontal pressure tank or vessel can expose property, the tank or vessel shall be placed with its longitudinal axis parallel to the nearest important exposure.

4.3.2.2 Shell-to-Shell Spacing Between Any Two Adjacent Aboveground Tanks.

4.3.2.2.1 Tanks storing Class I, Class II, or Class III stable liquids shall be separated by the distances given in Table 4.3.2.2.1.

Table 4.3.2.2.1 Minimum Tank Spacing (Shell-to-Shell)

Tank Diameter	Floating Roof Tanks	Fixed or Horizontal Tanks	
		Class I or II Liquids	Class IIIA I
All tanks not over 45 m (150 ft) in diameter	$\frac{1}{6} \times$ sum of adjacent tank diameters but not less than 0.9 m (3 ft)	$\frac{1}{6} \times$ sum of adjacent tank diameters but not less than 0.9 m (3 ft)	$\frac{1}{6} \times$ sum of adjacent tank diameters but not less than 0.9 m (3 ft)

Tanks larger than 45 m (150 ft) in diameter:

Table 4.3.2.2.1 Minimum Tank Spacing (Shell-to-Shell)

Tank Diameter	Floating Roof Tanks	Fixed or Horizontal Tanks	
		Class I or II Liquids	Class IIIA L
If remote impounding is provided in accordance with 4.3.2.3.1	$\frac{1}{6} \times$ sum of adjacent tank diameters	$\frac{1}{4} \times$ sum of adjacent tank diameters	$\frac{1}{6} \times$ sum of adjacent tank diameters
If diking is provided in accordance with 4.3.2.3.2	$\frac{1}{4} \times$ sum of adjacent tank diameters	$\frac{1}{3} \times$ sum of adjacent tank diameters	$\frac{1}{4} \times$ sum of adjacent tank diameters

Exception No. 1: Tanks storing crude petroleum that have individual capacities not exceeding 480 m³ (126,000 gal or 3000 bbl) and that are located at production facilities in isolated locations do not need to be separated by more than 0.9 m (3 ft).

Exception No. 2: Tanks used only for storing Class IIIB liquids need not be separated by more than 0.9 m (3 ft) provided they are not within the same diked area as, or within the drainage path of, a tank storing a Class I or Class II liquid.

4.3.2.2.2 A tank storing unstable liquid shall be separated from any other tank containing either an unstable liquid or a Class I, II, or III liquid by a distance not less than one-half the sum of their diameters.

4.3.2.2.3 Where tanks are in a diked area containing Class I or Class II liquids or in the drainage path of Class I or Class II liquids and are compacted in three or more rows or in an irregular pattern, greater spacing or other means shall be permitted to be required by the authority having jurisdiction to make tanks in the interior of the pattern accessible for fire-fighting purposes.

4.3.2.2.4 The minimum horizontal separation between an LP-Gas container and a Class I, Class II, or Class IIIA liquid storage tank shall be 6 m (20 ft). Suitable measures shall be taken to prevent the accumulation of Class I, Class II, or Class IIIA liquids under adjacent LP-Gas containers such as by dikes, diversion curbs, or grading. Where flammable or combustible liquid storage tanks are within a diked area, the LP-Gas containers shall be outside the diked area and at least 3 m (10 ft) away from the centerline of the wall of the diked area.

Exception No. 1: If a tank storing a Class I, Class II, or Class IIIA liquid operates at pressures exceeding a gauge pressure of 17 kPa (2.5 psig) or is equipped with emergency relief venting that will permit pressures to exceed a gauge pressure of 17 kPa (2.5 psig), it shall be separated from an LP-Gas container by the distance given in 4.3.2.2.1.

Exception No. 2: The requirements of 4.3.2.2.4 shall not apply where LP-Gas containers of 475 L (125 gal) or less capacity are installed adjacent to fuel oil supply tanks of 2500 L (660 gal) or less capacity.

4.3.2.3 Control of Spills from Aboveground Tanks. Every tank that contains a Class I, Class II, or Class IIIA liquid shall be provided with means to prevent an accidental release of liquid from endangering important facilities and adjoining property or from reaching waterways. Such means shall meet the requirements of 4.3.2.3.1, 4.3.2.3.2, or 4.3.2.3.3,

whichever is applicable.

4.3.2.3.1 Remote Impounding. Where control of spillage is by means of drainage to a remote impounding area, so that impounded liquid will not be held against tanks, such systems shall comply with the following:

- (1) A slope of not less than 1 percent away from the tank shall be provided for at least 15 m (50 ft) toward the impounding area.
- (2) The impounding area shall have a capacity not less than that of the largest tank that can drain into it.

Exception: Where this is not possible because there is not enough open area around the tanks or is impractical, "partial" remote impounding for some percentage of the required capacity remote from any tank or adjoining property shall be permitted to be provided. The required volume exceeding the capacity of the partial remote impoundment shall be provided for by diking meeting the requirements of 4.3.2.3.2.

- (3) The route of the drainage system shall be so located that, if the liquid in the drainage system is ignited, the fire will not seriously expose tanks or adjoining property.
- (4) The confines of the impounding area shall be located so that, when filled to capacity, the liquid level will not be closer than 15 m (50 ft) from any property line that is or can be built upon or from any tank. Where partial remote impounding is used, the liquid level in the partial impounding shall meet the requirements of 4.3.2.3.1. The excess volume shall meet the requirements of impounding by diking as provided or as in 4.3.2.3.2. Tank spacing shall be determined based on the diked tank provisions of Table 4.3.2.2.1.

4.3.2.3.2 Impounding Around Tanks by Diking. Where protection of adjoining property or waterways is by means of impounding by diking around the tanks, such systems shall comply with 4.3.2.3.2(A) through 4.3.2.3.2(H).

(A) A slope of not less than 1 percent away from the tank shall be provided for at least 15 m (50 ft) or to the dike base, whichever is less.

(B)* The volumetric capacity of the diked area shall not be less than the greatest amount of liquid that can be released from the largest tank within the diked area, assuming a full tank. To allow for volume occupied by tanks, the capacity of the diked area enclosing more than one tank shall be calculated after deducting the volume of the tanks, other than the largest tank, below the height of the dike.

(C) To permit access, the outside base of the dike at ground level shall be no closer than 3 m (10 ft) to any property line that is or can be built upon.

(D)* Walls of the diked area shall be of earth, steel, concrete, or solid masonry designed to be liquidtight and to withstand a full hydrostatic head. Earthen walls 0.9 m (3 ft) or more in height shall have a flat section at the top not less than 0.6 m (2 ft) wide. The slope of an earthen wall shall be consistent with the angle of repose of the material of which the wall is constructed.

(E) The walls of the diked area shall be restricted to an average interior height of 1.8 m (6

ft) above interior grade.

Exception: Dikes shall be permitted to exceed this height where provisions are made for normal access, necessary emergency access to tanks, valves, and other equipment, and safe egress from the diked enclosure, and where the following requirements are met:

- (1) *Where the average height of the dike containing Class I liquids is over 3.6 m (12 ft) high, measured from interior grade, or where the distance between any tank and the top inside edge of the dike wall is less than the height of the dike wall, provisions shall be made for normal operation of valves and for access to tank roof(s) without entering below the top of the dike. These provisions shall be permitted to be met through the use of remote-operated valves, elevated walkways, or similar arrangements.*
- (2) *Piping passing through dike walls shall be designed to prevent excessive stresses as a result of settlement or fire exposure.*
- (3) *The minimum distance between tanks and toe of the interior dike walls shall be 1.5 m (5 ft).*

(F) Each diked area containing two or more tanks shall be subdivided, preferably by drainage channels or at least by intermediate dikes, in order to prevent spills from endangering adjacent tanks within the diked area as follows:

- (1) Where storing normally stable liquids in vertical cone roof tanks constructed with weak roof-to-shell seams or in floating roof tanks, or when storing crude petroleum in producing areas in any type of tank, one subdivision shall be provided for each tank greater than 1590 m³ (420,000 gal or 10,000 bbl) capacity. In addition, one subdivision shall be provided for each group of tanks [no individual tank exceeding 1590 m³ (420,000 gal or 10,000 bbl) capacity] having an aggregate capacity not greater than 2385 m³ (630,000 gal or 15,000 bbl).
- (2) Where storing normally stable liquids in tanks not covered in 4.3.2.3.2(F)(1), one subdivision shall be provided for each tank greater than 380 m³ (100,000 gal or 2380 bbl) capacity. In addition, one subdivision shall be provided for each group of tanks [no individual tank exceeding 380 m³ (100,000 gal or 2380 bbl) capacity] having an aggregate capacity not greater than 570 m³ (150,000 gal or 3570 bbl).
- (3)* Where storing unstable liquids in any type of tank, one subdivision shall be provided for each tank.

Exception: Tanks installed with drainage meeting the requirements of NFPA 15, Standard for Water Spray Fixed Systems for Fire Protection, need not meet this requirement.

- (4) Whenever two or more tanks storing Class I liquids, any one of which is over 45 m (150 ft) in diameter, are located in a common diked area, intermediate dikes shall be provided between adjacent tanks to hold at least 10 percent of the capacity of the tank so enclosed, not including the volume displaced by the tank.
- (5) The drainage channels or intermediate dikes shall be located between tanks so as to take full advantage of the available space with due regard for the individual tank capacities. Intermediate dikes, where used, shall be not less than 450 mm (18 in.) in height.

(G) Where provision is made for draining water from diked areas, such drains shall be controlled to prevent liquids from entering natural water courses, public sewers, or public drains. Control of drainage shall be accessible under fire conditions from outside the dike.

(H) Storage of combustible materials, empty or full drums, or barrels, shall not be permitted within the diked area.

4.3.2.3.3 Secondary Containment Tanks. Where a secondary containment tank is used to provide spill control, the tank shall meet all of the following requirements:

- (1) The capacity of the tank shall not exceed 45,400 L (45.4 m³ or 12,000 gal).
- (2) All piping connections to the tank shall be made above the normal maximum liquid level.
- (3) Means shall be provided to prevent the release of liquid from the tank by siphon flow.
- (4) Means shall be provided for determining the level of liquid in the tank. This means shall be accessible to the delivery operator.
- (5) Means shall be provided to prevent overfilling by sounding an alarm when the liquid level in the tank reaches 90 percent of capacity and by automatically stopping delivery of liquid to the tank when the liquid level in the tank reaches 95 percent of capacity. In no case shall these provisions restrict or interfere with the proper functioning of the normal vent or the emergency vent.
- (6) Spacing between adjacent tanks shall be not less than 0.9 m (3 ft).
- (7) The tank shall be capable of resisting the damage from the impact of a motor vehicle or suitable collision barriers shall be provided.
- (8) Where the means of secondary containment is enclosed, it shall be provided with emergency venting in accordance with 4.2.5.2.
- (9) Means shall be provided to establish the integrity of the secondary containment, in accordance with 4.4.2.3 and 4.4.2.4. The secondary containment shall be designed to withstand the hydrostatic head resulting from a leak from the primary tank of the maximum amount of liquid that can be stored in the primary tank.

4.3.2.3.4 Equipment, Piping, and Fire Protection Systems in Remote Impoundment Areas or Diked Areas.

4.3.2.3.4.1* Piping Location. Only piping for product, utility, or fire protection purposes directly connected to a tank or tanks within a single diked area shall be routed through a diked area, a remote impoundment area, a spillway draining to a remote impoundment area, or above a storage tank drainage area where the piping can be exposed to a fire.

Exception: Piping for other product lines and from adjacent tanks shall be permitted to be routed through such areas if engineering designs are provided to incorporate features to prevent the piping from creating an exposure hazard.

4.3.2.3.4.2 Drainage. Drainage shall be arranged to prevent accumulation of any liquid under the piping by sloping the grade in accordance with 4.3.2.3.2. Corrosion-resistant

pipings and piping that is protected against corrosion shall be permitted to be buried where such drainage is not provided or is not practical.

4.3.2.3.4.3* Equipment Location. If located in a remote impoundment area, a diked area, or a spillway draining to a remote impoundment area, process equipment, pumps, instrumentation, and electrical utilization equipment shall be located or protected so that a fire involving such equipment does not constitute an exposure hazard to the tank or tanks in the same area for a period of time consistent with the response and suppression capabilities of the fire-fighting operations available to the location.

4.3.2.3.4.4 Fire Protection Systems. Hose connections, controls, and control valves for application of fire protection foam or water to tanks shall be located outside remote impoundment areas, diked areas, or spillways draining to a remote impoundment area.

4.3.2.3.4.5 Combustible Materials. Structures such as stairways, walkways, instrumentation shelters, and supports for piping and equipment that are located in a remote impoundment area, diked area, or spillway draining to a remote impoundment area shall be constructed of noncombustible materials.

4.3.2.4 Vent Piping for Aboveground Tanks. Piping for normal and emergency relief venting shall be constructed in accordance with Chapter 5.

4.3.2.5 Tank Openings Other than Vents for Aboveground Tanks.

4.3.2.5.1 Each connection to an aboveground tank through which liquid can normally flow shall be provided with an internal or an external valve located as close as practical to the shell of the tank.

4.3.2.5.2 Each connection below the liquid level through which liquid does not normally flow shall be provided with a liquidtight closure such as a valve, plug, or blind, or a combination of these.

4.3.2.5.3 Openings for gauging on tanks storing Class I liquids shall be provided with a vaportight cap or cover.

4.3.2.5.4* Fill pipes that enter the top of a tank shall terminate within 150 mm (6 in.) of the bottom of the tank. Fill pipes shall be installed or arranged so that vibration is minimized.

Exception No. 1: Fill pipes in tanks whose vapor space under the expected range of normal operating conditions is not in the flammable range or is inerted need not meet this requirement.

Exception No. 2: Fill pipes in tanks handling liquids with minimal potential for accumulation of static electricity need not meet this requirement provided that the fill line is designed and the system is operated to avoid mist generation and an adequate level of residence time is provided downstream of filters or screens such that the charge generated is dissipated.

4.3.2.5.5 Filling and emptying connections for Class I, Class II, and Class IIIA liquids that are connected and disconnected shall be located outside of buildings at a location free from any source of ignition. They shall be located not less than 1.5 m (5 ft) away from any

building opening. Such connections for any liquid shall be closed and liquidtight when not in use and shall be properly identified.

4.3.2.6 Requirements for Aboveground Tanks Located in Areas Subject to Flooding.

4.3.2.6.1 Vertical tanks shall be located so that the tops of the tanks extend above the maximum flood stage by at least 30 percent of their allowable storage capacity.

4.3.2.6.2 Horizontal tanks that are located where more than 70 percent of the tank's storage capacity will be submerged at the established flood stage shall be secured by one of the following methods:

- (1) Anchored to resist movement
- (2) Attached to a foundation of steel and concrete or of concrete having sufficient weight to provide adequate load for the tank when filled with liquid and submerged by flood water to the established flood stage
- (3) Adequately secured from floating by other means

4.3.2.6.3 Tank vents or other openings that are not liquidtight shall extend above the maximum flood stage water level.

4.3.2.6.4 A dependable water supply shall be available for filling an empty or partially filled tank.

Exception: Where filling the tank with water is impractical or hazardous because of the contents of the tank, the tank shall be protected by other means against movement or collapse.

4.3.2.6.5 Spherical or spheroid tanks shall be protected by any of the methods specified in this 4.3.2.6.

4.3.2.7 Collision Protection. Where a tank might be exposed to vehicular impact, protection shall be provided to prevent damage to the tank.

4.3.2.8 Installation Instructions. Factory-built aboveground tanks shall be provided with instructions for testing and for installation of the normal and emergency vents.

4.3.3 Installation of Underground Tanks.

4.3.3.1 Location. Excavation for underground tanks shall be made with due care to avoid undermining of foundations of existing structures. Underground tanks or tanks under buildings shall be so located with respect to existing building foundations and supports that the loads carried by the latter cannot be transmitted to the tank. The distance from any part of a tank storing Class I liquids to the nearest wall of any basement or pit shall be not less than 0.3 m (1 ft), and to any property line that can be built upon, not less than 0.9 m (3 ft). The distance from any part of a tank storing Class II or Class III liquids to the nearest wall of any basement, pit, or property line shall be not less than 0.3 m (1 ft).

4.3.3.2 Burial Depth and Cover.

4.3.3.2.1* All underground tanks shall be installed in accordance with the manufacturer's

instructions and shall be set on firm foundations and surrounded with at least 150 mm (6 in.) of noncorrosive inert material such as clean sand or gravel well-tamped in place. The tank shall be placed in the hole with care.

4.3.3.2.2 Underground tanks shall be covered with not less than 600 mm (24 in.) of earth, or with not less than 300 mm (12 in.) of earth on top of which shall be placed a slab of reinforced concrete not less than 100 mm (4 in.) thick. Where the tanks are, or are likely to be, subjected to traffic, they shall be protected against damage from vehicles passing over them by at least 900 mm (36 in.) of earth cover, or 450 mm (18 in.) of well-tamped earth plus either 150 mm (6 in.) of reinforced concrete or 200 mm (8 in.) of asphaltic concrete. When asphaltic or reinforced concrete paving is used as part of the protection, it shall extend at least 300 mm (12 in.) horizontally beyond the outline of the tank in all directions.

4.3.3.2.3 Maximum depth of cover shall be specified by the tank manufacturer and marked on the tank. When the depth of cover is greater than the diameter of the tank or if the pressure at the bottom of the tank can exceed a gauge pressure of 69 kPa (10 psig), the manufacturer of the tank shall be consulted to determine if reinforcement of the tank is required. The specific gravity of the liquid to be stored shall be a design factor.

4.3.3.3 Vent Piping for Underground Tanks. Vent pipes from underground tanks shall be installed in accordance with Chapter 5.

4.3.3.4 Tank Openings Other than Vents for Underground Tanks.

4.3.3.4.1 Connections for all tank openings shall be liquidtight.

4.3.3.4.2 Openings for manual gauging, if independent of the fill pipe, shall be provided with a liquidtight cap or cover. Covers shall be kept closed when not gauging. If inside a building, each such opening shall be protected against liquid overflow and possible vapor release by means of a spring-loaded check valve or other approved device.

4.3.3.4.3 Fill and discharge lines shall enter tanks only through the top. Fill lines shall be sloped toward the tank. Underground tanks for Class I liquids having a capacity of more than 3800 L (1000 gal) shall be equipped with a tight fill device for connecting the fill hose to the tank.

4.3.3.4.4 Fill pipes that enter the top of a tank shall terminate within 150 mm (6 in.) of the bottom of the tank. Fill pipes shall be installed or arranged so that vibration is minimized.

Exception No. 1: Fill pipes in tanks whose vapor space under the expected range of normal operating conditions is not in the flammable range or is inerted need not meet this requirement.

Exception No. 2: Fill pipes in tanks handling liquids with minimal potential for accumulation of static electricity need not meet this requirement provided that the fill line is designed and the system operated to avoid mist generation and an adequate level of residence time is provided downstream of filters or screens such that the charge generated is dissipated. (See A.4.3.2.5.4.)

4.3.3.4.5 Filling and emptying and vapor recovery connections for Class I, Class II, or Class IIIA liquids that are connected and disconnected shall be located outside of buildings at a

location free from any source of ignition and not less than 1.5 m (5 ft) away from any building opening. Such connections shall be closed and liquidtight when not in use and shall be properly identified.

4.3.3.4.6 Tank openings provided for purposes of vapor recovery shall be protected against possible vapor release by means of a spring-loaded check valve or dry-break connection, or other approved device, unless the opening is pipe-connected to a vapor processing system. Openings designed for combined fill and vapor recovery shall also be protected against vapor release unless connection of the liquid delivery line to the fill pipe simultaneously connects the vapor recovery line. All connections shall be vaportight.

4.3.3.5 Requirements for Underground Tanks Located in Areas Subject to Flooding.

4.3.3.5.1 At locations where an ample and dependable water supply is available, underground tanks containing flammable or combustible liquids, placed so that more than 70 percent of their storage capacity will be submerged at the maximum flood stage, shall be so anchored, weighted, or secured as to prevent movement when filled or loaded with water and submerged by floodwater to the established flood stage. Tank vents or other openings that are not liquidtight shall be extended above maximum flood stage water level.

4.3.3.5.2 At locations where an ample and dependable water supply is not available or where filling of underground tanks with water is impractical because of the contents, each tank shall be safeguarded against movement when empty and submerged by high groundwater or floodwater by anchoring or by securing by other means. Each such tank shall be so constructed and installed that it will safely resist external pressures if submerged.

4.3.4 Storage Tank Buildings.

4.3.4.1* Scope. Subsection 4.3.4 shall apply to installations of tanks storing Class I, Class II, and Class IIIA liquids in storage tank buildings. This subsection shall not specifically apply to such tanks in process areas. (*See Chapter 7.*) Tanks storing Class IIIB liquids shall not be required to comply with the provisions of this subsection. A tank installation that has a canopy or roof that does not limit the dissipation of heat or dispersion of flammable vapors and does not restrict fire-fighting access and control shall be treated as an outside aboveground tank. (*See 3.3.6.3.*)

Exception: Tanks that meet the requirements of Section 7.5.

4.3.4.2 Location. Tanks and any associated equipment within the storage tank building shall be so located that a fire in the area shall not constitute an exposure hazard to adjoining buildings or tanks for a period of time consistent with the response and suppression capabilities of the fire-fighting operations available to the location. Compliance with 4.3.4.2.1 through 4.3.4.2.5 shall be deemed as meeting the requirements of 4.3.4.2.

4.3.4.2.1 The minimum distance from exposed property lines and buildings for tank installations within structures having walls with a fire resistance rating of less than 2 hours shall be in accordance with Table 4.3.4.2.1. Capacity of any individual tank shall not exceed

Exception: Tanks that meet the requirements of Section 7.5.

4.3.4.2 Location. Tanks and any associated equipment within the storage tank building shall be so located that a fire in the area shall not constitute an exposure hazard to adjoining buildings or tanks for a period of time consistent with the response and suppression capabilities of the fire-fighting operations available to the location. Compliance with 4.3.4.2.1 through 4.3.4.2.5 shall be deemed as meeting the requirements of 4.3.4.2.

4.3.4.2.1 The minimum distance from exposed property lines and buildings for tank installations within structures having walls with a fire resistance rating of less than 2 hours shall be in accordance with Table 4.3.4.2.1. Capacity of any individual tank shall not exceed 380 m³ (100,000 gal or 2380 bbl) without the approval of the authority having jurisdiction.

Table 4.3.4.2.1 Location of Storage Tank Buildings with Respect to Property Lines, Public Buildings, and Other Important Building on the Same Property†

Largest Tank — Operating Liquid Capacity (gal)	Minimum Distance from Property Line that Is or Can Be Built Upon, Including Opposite Side of Public Way (ft)				Minimum Distance from Nearest Building on Same Property	
	Stable Liquid Emergency Relief		Unstable Liquid Emergency Relief		Stable Liquid Emergency Relief	
	Not over 2.5 psig	Over 2.5 psig	Not over 2.5 psig	Over 2.5 psig	Not over 2.5 psig	Over 2.5 psig
Up to 12,000	15	25	40	60	5	10
12,001 to 30,000	20	30	50	80	5	10
30,001 to 50,000	30	45	75	120	10	15
50,001 to 100,000	50	75	125	200	15	25

Note: For SI units, 1 gal = 3.8 L; 1 ft = 0.3 m; 1 psig = 6.9 kPa.

†Double all distances shown if protection for exposures is not provided. Distances need not exceed 90 m (300 ft).

Exception: As modified by 4.3.4.2.2.

4.3.4.2.2 Where a storage tank building has an exterior wall facing an exposure, the distances in Table 4.3.4.2.1 shall be permitted to be modified as follows:

- (1) Where the wall is a blank wall having a fire resistance rating of not less than 2 hours, separation distance between the storage tank building and its exposure need not be greater than 7.6 m (25 ft).
- (2)* Where a blank wall having a fire resistance rating of not less than 4 hours is provided, the distance requirements of Table 4.3.4.2.1 shall not apply. In addition, where Class IA or unstable liquids are stored, the exposing wall shall have explosion resistance in accordance with recognized engineering standards, and adequate deflagration venting shall be provided in the nonexposing walls and roof.

4.3.4.2.3 Other equipment associated with tanks, such as pumps, heaters, filters, and exchangers, shall not be located closer than 7.6 m (25 ft) to property lines where the adjoining property is or can be built upon or to the nearest important building on the same property that is not an integral part of the storage tank building.

Exception: This spacing requirement shall not apply where exposures are protected as outlined in 4.3.4.2.2.

4.3.4.2.4 Tanks in which unstable liquids are stored shall be separated from potential fire exposures by a clear space of at least 7.6 m (25 ft) or by a wall having a fire resistance rating of not less than 2 hours.

4.3.4.2.5 Each storage tank building and each tank within the building shall be accessible from at least two sides for fire fighting and fire control.

4.3.4.3 Construction of Tank Buildings.

4.3.4.3.1 Storage tank buildings shall be constructed so as to maintain structural integrity for 2 hours under fire exposure conditions and to provide adequate access and egress for unobstructed movement of all personnel and fire protection equipment. Compliance with 4.3.4.3.2 through 4.3.4.3.7 shall be deemed as meeting the requirements of 4.3.4.3.1.

4.3.4.3.2* Buildings or structures shall be of at least 2-hour fire resistance rating except that noncombustible or combustible construction shall be permitted when protected by automatic sprinklers or equivalent protection subject to the approval of the authority having jurisdiction.

4.3.4.3.3 Class I liquids and Class II or Class IIIA liquids heated above their flash points shall not be stored in basements. Means shall be provided to prevent liquid spills from running into basements. Where Class I liquids are stored above grade within buildings with basements or other belowgrade areas into which flammable vapors can travel, such belowgrade areas shall be provided with mechanical ventilation designed to prevent the accumulation of flammable vapors. Enclosed storage tank pits shall not be considered basements.

4.3.4.3.4* Storage tanks shall be separated from other occupancies within the building by construction having at least a 2-hour fire resistance rating. As a minimum, each opening shall be protected by either a listed, self-closing fire door or a listed fire damper having a minimum 1-hour fire protection rating. The fire door or fire damper shall be installed in accordance with NFPA 80, *Standard for Fire Doors and Fire Windows*; NFPA 90A, *Standard for the Installation of Air-Conditioning and Ventilating Systems*; or NFPA 91, *Standard for Exhaust Systems for Air Conveying of Vapors, Gases, Mists, and Noncombustible Particulate Solids*; whichever is applicable. Where Class IA or unstable liquids are being stored, deflagration vents shall be provided to the exterior of the building, and any walls separating this storage from other occupancies shall have explosion resistance in accordance with recognized engineering standards. Adequate deflagration venting shall be provided for the nonexposing walls.

4.3.4.3.5* Storage tank buildings shall have exit facilities arranged to prevent occupants from being trapped in the event of fire. Exits shall not be exposed by the drainage facilities described in 4.3.4.5.

4.3.4.3.6 Access aisles of at least 0.9 m (3 ft) shall be maintained for movement of fire-fighting personnel and fire protection equipment.

4.3.4.3.7 Clearance between the top of the tank and the building structure shall be a minimum of 0.9 m (3 ft) for buildings protected in accordance with 4.3.4.12.3. For buildings without fixed fire suppression systems, space shall be provided to allow for the application of hose streams to the top of the tank(s) for cooling purposes.

4.3.4.4 Ventilation of Tank Buildings.

4.3.4.4.1 Storage tank buildings storing Class I liquids, or Class II or Class IIIA liquids at temperatures above their flash points, shall be ventilated at a rate sufficient to maintain the concentration of vapors within the building at or below 25 percent of the lower flammable limit. Compliance with 4.3.4.4.2 through 4.3.4.4.5 shall be deemed as meeting the requirements of 4.3.4.4.1.

4.3.4.4.2* Ventilation requirements shall be confirmed by one of the following procedures:

- (1) Calculations based on the anticipated fugitive emissions. (*See Annex F for calculation methods.*)
- (2) Sampling of the actual vapor concentration under normal operating conditions. The sampling shall be conducted at a distance of 1.5 m (5 ft) radius from each potential vapor source extending to or toward the bottom and the top of the enclosed storage area. The vapor concentration used to determine the required ventilation rate shall be the highest measured concentration during the sampling procedure.
- (3) Ventilation at a rate of not less than 0.3 m³/min of exhaust air for each m² of solid floor area (1 cfm/ft²).

4.3.4.4.3 Ventilation shall be accomplished by natural or mechanical ventilation, with discharge or exhaust to a safe location outside the building, without recirculation of the exhaust air.

Exception: Recirculation is permitted where it is monitored continuously using a fail-safe system that is designed to automatically sound an alarm, stop recirculation, and provide full exhaust to the outside in the event that vapor-air mixtures having concentrations over 25 percent of the lower flammable limit are detected.

4.3.4.4.4* Provision shall be made for introduction of make-up air in such a manner as to avoid short-circuiting the ventilation. Ventilation shall be arranged to include all floor areas or pits where flammable vapors can collect. Where natural ventilation is inadequate, mechanical ventilation shall be provided and shall be kept in operation while flammable liquids are being handled. Local or spot ventilation, if provided, shall be permitted to be used for up to 75 percent of the required ventilation.

4.3.4.4.5 For storage tank buildings with the interior grade more than 300 mm (1 ft) below the average exterior grade, continuous mechanical ventilation in accordance with 4.3.4.4.2(3) shall be provided or a vapor detection system shall be provided and set to give a warning alarm at 25 percent of the lower flammable limit and to start the mechanical ventilation system. The alarm shall sound at a constantly attended location.

4.3.4.5 Drainage from Tank Buildings.

4.3.4.5.1 Drainage systems shall be designed to minimize fire exposure to other tanks and adjacent properties or waterways. Compliance with 4.3.4.5.2 through 4.3.4.5.6 shall be deemed as meeting the requirements of 4.3.4.5.1.

4.3.4.5.2 A facility shall be designed and operated to prevent the normal discharge of flammable or combustible liquids to public waterways, public sewers, or adjoining property.

4.3.4.5.3 Except for drains, solid floors shall be liquidtight and the room shall be liquidtight where the walls join the floor and for at least 100 mm (4 in.) above the floor.

4.3.4.5.4 Openings in interior walls to adjacent rooms or buildings shall be provided with noncombustible, liquidtight raised sills or ramps at least 100 mm (4 in.) in height or shall be otherwise designed to prevent the flow of liquids to the adjoining areas. An open-grated trench across the width of the opening inside of the room that drains to a safe location shall be permitted to be used as an alternative to a sill or ramp.

4.3.4.5.5* The containment area shall have a capacity not less than that of the largest tank that can drain into it. Emergency drainage systems shall be provided to direct flammable or combustible liquid leakage and fire protection water to a safe location. Curbs, scuppers, or special drainage systems shall be permitted to be used. *(See 4.3.2.3.)*

4.3.4.5.6 Emergency drainage systems, if connected to public sewers or discharged into public waterways, shall be equipped with traps or separators.

4.3.4.6 Vents for Tanks Inside Tank Buildings.

4.3.4.6.1 Vents for tanks inside tank buildings shall be designed to ensure that vapors are not released inside the building. Compliance with 4.3.4.6.2 and 4.3.4.6.3 shall be deemed as meeting the requirements of 4.3.4.6.1.

4.3.4.6.2 Vents for tanks inside tank buildings shall be as required in 4.2.5.1 and 4.2.5.2,

except that emergency venting by the use of weak roof-to-shell seam shall not be permitted. Automatic sprinkler systems designed in accordance with the requirements of NFPA 13, *Standard for the Installation of Sprinkler Systems*, shall be accepted by the authority having jurisdiction as equivalent to water spray systems for purposes of calculating the required airflow rates for emergency vents in 4.2.5.2.6, provided the density and coverage requirements of NFPA 15, *Standard for Water Spray Fixed Systems for Fire Protection*, are met. Vents shall terminate outside the building.

4.3.4.6.3 Piping for normal and emergency relief venting shall meet the requirements of Chapter 5.

4.3.4.7 Tank Openings Other than Vents for Tanks Inside Tank Buildings.

4.3.4.7.1 Tank openings other than vents for tanks inside tank buildings shall be designed to ensure that flammable liquids or vapors are not released inside the building. Compliance with 4.3.4.7.2 through 4.3.4.7.9 shall be deemed as meeting the requirements of 4.3.4.7.1.

4.3.4.7.2 All tank openings that are located at or below the maximum liquid level shall be liquidtight; those that are located above the maximum liquid level shall be normally closed and shall be mechanically secured to prevent release of vapors.

4.3.4.7.3 Each connection through which liquid can gravity flow from a tank inside a building shall be provided with an internal or an external valve located as close as practical to the shell of the tank.

4.3.4.7.4 Each liquid transfer connection on any tank storing Class I or Class II liquids inside buildings shall be provided with one of the following:

- (1) A normally closed remotely activated valve
- (2) An automatic-closing, heat-activated valve
- (3) Another approved device

Exception: Connections used for emergency disposal or to provide for quick cutoff of flow in the event of fire in the vicinity of the tank need not meet this requirement.

4.3.4.7.4.1 The requirements of 4.3.4.7.4 shall be permitted to be met by the valve required in 4.3.4.7.3. If a separate valve is used, it shall be located adjacent to the valve required in 4.3.4.7.3.

4.3.4.7.5* Openings for manual gauging of Class I or Class II liquids, if independent of the fill pipe, shall be provided with a vaportight cap or cover. Openings shall be kept closed when not in use. Each such opening for any liquid shall be protected against liquid overflow and possible vapor release by means of a spring-loaded check valve or other approved device.

4.3.4.7.6 Fill pipes that enter the top of a tank shall terminate within 150 mm (6 in.) of the bottom of the tank. Fill pipes shall be installed or arranged so that vibration is minimized.

Exception No. 1: Fill pipes in tanks whose vapor space under the expected range of normal operating conditions is not in the flammable range or is inerted need not meet this

requirement.

Exception No. 2: Fill pipes in tanks handling liquids with minimal potential for accumulation of static electricity need not meet this requirement provided that the fill line is designed and the system operated to avoid mist generation and an adequate level of residence time is provided downstream of filters or screens such that the charge generated is dissipated. (See A.4.3.2.5.4.)

4.3.4.7.7 The inlet of the fill pipe and the outlet of a vapor recovery line for which connections to tank vehicles and tank cars are made and broken shall be located outside of buildings at a location free from any source of ignition and not less than 1.5 m (5 ft) away from any building opening. Such connections shall be closed tight and protected against tampering when not in use and shall be identified.

4.3.4.7.8* Tanks storing Class I, Class II, or Class IIIA liquids inside buildings shall be equipped with a device, or other means shall be provided, to prevent overflow into the building.

4.3.4.7.9 Tank openings provided for purposes of vapor recovery shall be protected against possible vapor release by means of a spring-loaded check valve or dry-break connection or other approved device, unless the opening is pipe-connected to a vapor processing system. Openings designed for combined fill and vapor recovery shall also be protected against vapor release unless connection of the liquid delivery line to the fill pipe simultaneously connects the vapor recovery line. All connections shall be vaportight.

4.3.4.8 Electrical Systems for Tank Buildings. Installation of electrical utilization equipment and wiring shall meet the requirements of Chapter 8. Chapter 8 shall be used to determine the extent of classified locations for the purpose of installation of electrical equipment. In establishing the extent of a classified location, it shall not extend beyond a floor, wall, roof, or other solid partition that has no openings, within the classified area.

4.3.4.9 Inspection and Maintenance for Tank Buildings.

4.3.4.9.1 Combustible waste material and residues in operating areas shall be kept to a minimum, stored in covered metal containers, and disposed of daily.

4.3.4.9.2 Storage of combustible materials and empty or full drums or barrels shall not be permitted within the storage tank building.

4.3.4.10 Detection and Alarm for Tank Buildings.

4.3.4.10.1 An approved means shall be provided to promptly notify those within the plant and the available public or mutual aid fire department of any fire or other emergency.

4.3.4.10.2 Those areas, including buildings, where the potential exists for a flammable liquid spill shall be monitored as appropriate. Such methods shall include both of the following:

- (1) Personnel observation or patrol
- (2) Monitoring equipment that indicates a spill or leak has occurred in an unattended area

4.3.4.11 Portable Fire Control Equipment for Tank Buildings.

4.3.4.11.1* Listed portable fire extinguishers shall be provided for facilities in such quantities, sizes, and types as could be needed for special storage hazards as determined in accordance with 4.5.2.

4.3.4.11.2* Where the need is indicated in accordance with 4.5.4, water shall be utilized through standpipe and hose systems, or through hose connections from sprinkler systems using combination spray and straight stream nozzles to permit effective fire control.

4.3.4.11.3 Where the need is indicated in accordance with 4.5.4, mobile foam apparatus shall be provided.

4.3.4.11.4 Automotive and trailer-mounted fire apparatus, where determined necessary, shall not be used for any purpose other than fire fighting or training.

4.3.4.12 Fixed Fire Control Equipment for Tank Buildings.

4.3.4.12.1 A reliable water supply or other suitable fire control agent shall be available in pressure and quantity to meet the fire demands indicated by special storage hazards or exposure as determined by 4.5.4.

4.3.4.12.2* Hydrants, with or without fixed monitor nozzles, shall be provided in accordance with accepted practice. The number and placement shall depend on the hazard of the storage, or exposure, as determined by 4.5.4.

4.3.4.12.3* Where the need is indicated by the hazards of storage or exposure as determined by 4.5.4, fixed protection shall be required utilizing approved foam, foam-water sprinkler systems, sprinkler systems, water spray systems, deluge systems, fire-resistive materials, or a combination of these. When foam or foam-water fire protection systems are provided, discharge densities shall be determined based on the listing criteria for selected foam discharge devices, the foam concentrate, and the specific flammable or combustible liquids to be protected.

4.3.4.12.4 If provided, fire control systems shall be designed, installed, and maintained in accordance with the following NFPA standards:

- (1) NFPA 11, *Standard for Low-, Medium-, and High-Expansion Foam*
- (2) NFPA 11A, *Standard for Medium- and High-Expansion Foam Systems*
- (3) NFPA 12, *Standard on Carbon Dioxide Extinguishing Systems*
- (4) NFPA 12A, *Standard on Halon 1301 Fire Extinguishing Systems*
- (5) NFPA 13, *Standard for the Installation of Sprinkler Systems*
- (6) NFPA 15, *Standard for Water Spray Fixed Systems for Fire Protection*
- (7) NFPA 16, *Standard for the Installation of Foam-Water Sprinkler and Foam-Water Spray Systems*
- (8) NFPA 17, *Standard for Dry Chemical Extinguishing Systems*
- (9) NFPA 25, *Standard for the Inspection, Testing, and Maintenance of Water-Based Fire Protection Systems*

4.4 Testing Requirements for Tanks.

4.4.1 Initial Testing. All tanks, whether shop-built or field-erected, shall be tested before they are placed in service in accordance with the applicable requirements of the code under which they were built.

4.4.1.1 An approved listing mark on a tank shall be considered to be evidence of compliance with this requirement. Tanks not so marked shall be tested before they are placed in service in accordance with recognized engineering standards or in accordance with the requirements for testing in the codes listed in 4.2.3.1.1, 4.2.3.2.1, or 4.2.3.3.1.

4.4.1.2 Where the vertical length of the fill and vent pipes is such that, when filled with liquid, the static head imposed on the bottom of the tank exceeds a gauge pressure of 70 kPa (10 psi), the tank and its related piping shall be tested hydrostatically to a pressure equal to the static head thus imposed. In special cases where the height of the vent above the top of the tank is excessive, the hydrostatic test pressure shall be determined by using recognized engineering standards.

4.4.1.3 Before the tank is initially placed in service, all leaks or deformations shall be corrected in an acceptable manner. Mechanical caulking shall not be permitted for correcting leaks in welded tanks except for pinhole leaks in the roof.

4.4.1.4 Tanks to be operated at pressures below their design pressure shall be tested by the applicable provisions of 4.4.1.1 or 4.4.1.2 based upon the pressure developed under full emergency venting of the tank.

4.4.2* Tightness Testing. In addition to the tests called for in 4.4.1, all tanks and connections shall be tested for tightness after installation and before being placed in service in accordance with 4.4.2.1 through 4.4.2.4, as applicable. Except for underground tanks, this test shall be made at operating pressure with air, inert gas, or water. Air pressure shall not be used to test tanks that contain flammable or combustible liquids or vapors. (*See Section 6.6 for testing pressure piping.*)

Exception: For field-erected tanks, the tests required by 4.4.1.1 or 4.4.1.2 shall be permitted to be considered the test for tank tightness.

4.4.2.1 Horizontal shop-fabricated aboveground tanks shall be tested for tightness either hydrostatically or with air pressure at not less than a gauge pressure of 20 kPa (3 psig) and not more than a gauge pressure of 35 kPa (5 psig). Vertical shop-fabricated aboveground tanks shall be tested for tightness either hydrostatically or with air pressure at not less than a gauge pressure of 10 kPa (1.5 psig) and not more than a gauge pressure of 17 kPa (1.5 psig).

4.4.2.2 Single-wall underground tanks and piping, before being covered, enclosed, or placed in use, shall be tested for tightness either hydrostatically or with air pressure at not less than a gauge pressure of 20 kPa (3 psig) and not more than a gauge pressure of 35 kPa (5 psig).

4.4.2.3 Underground secondary containment tanks and horizontal aboveground secondary containment tanks shall have the primary (inner) tank tested for tightness either hydrostatically or with air pressure at not less than a gauge pressure of 20 kPa (3 psig) and not more than a gauge pressure of 35 kPa (5 psig). The interstitial space (annulus) of such

tanks shall be tested either hydrostatically or with air pressure at a gauge pressure of 20 to 35 kPa (3 to 5 psig), by vacuum at 18 kPa (5.3 in. Hg), or in accordance with the tank's listing or manufacturer's instructions. The pressure or vacuum shall be held for not less than 1 hour or for the duration specified in the listing procedures for the tank. Care shall be taken to ensure that the interstitial space is not overpressured or subjected to excessive vacuum.

4.4.2.4 Vertical aboveground secondary containment-type tanks shall have their primary (inner) tank tested for tightness either hydrostatically or with air pressure at not less than a gauge pressure of 10 kPa (1.5 psig) and not more than a gauge pressure of 17 kPa (2.5 psig). The interstitial space (annulus) of such tanks shall be tested either hydrostatically or with air pressure at a gauge pressure of 10 to 17 kPa (1.5 to 2.5 psig), by vacuum at 18 kPa (5.3 in. Hg), or in accordance with the tank's listing or manufacturer's instructions. The pressure or vacuum shall be held for 1 hour without evidence of leaks. Care shall be taken to ensure that the interstitial space is not overpressured or subjected to excessive vacuum.

4.4.3* Additional Testing. Tanks that have been relocated, structurally damaged, repaired, or are suspected of leaking shall be tested in a manner acceptable to the authority having jurisdiction.

4.5 Fire Prevention and Control.

4.5.1 Scope. Section 4.5 shall apply to the commonly recognized management techniques and fire control methods used to prevent or minimize the loss from fire or explosion in tank storage facilities. The wide range in size, design, and location of tank storage facilities shall preclude the inclusion of detailed fire prevention and control methods applicable to all such facilities. The authority having jurisdiction shall be permitted to be consulted on specific cases, where applicable; otherwise, qualified engineering judgment shall be exercised.

4.5.2 General Requirements. Tank storage facilities shall have fire prevention and control for life safety, for minimizing property loss, and for reducing fire exposure to adjoining facilities resulting from fire and explosion. Compliance with 4.5.3 through 4.5.7 shall be deemed as meeting the requirements of 4.5.2.

4.5.3 Control of Ignition Sources.

4.5.3.1 Precautions shall be taken to prevent the ignition of flammable vapors from sources such as the following:

- (1) Open flames
- (2) Lightning
- (3) Hot surfaces
- (4) Radiant heat
- (5) Smoking
- (6) Cutting and welding
- (7) Spontaneous ignition

- (8) Frictional heat or sparks
- (9) Static electricity
- (10) Electrical sparks
- (11) Stray currents
- (12) Ovens, furnaces, and heating equipment

4.5.3.2 Smoking shall be permitted only in designated and properly identified areas.

4.5.3.3* Welding, cutting, and similar spark-producing operations shall not be permitted in areas containing flammable liquids until a written permit authorizing such work has been issued. The permit shall be issued by a person in authority following inspection of the area to assure that proper precautions have been taken and will be followed until the job is completed.

4.5.3.4* Static Electricity. All equipment such as tanks, machinery, and piping shall be designed and operated to prevent electrostatic ignitions. All metallic equipment where an ignitable mixture could be present shall be bonded or grounded. The bond or ground or both shall be physically applied or shall be inherently present by the nature of the installation. Any electrically isolated section of metallic piping or equipment shall be bonded or grounded to prevent hazardous accumulation of static electricity. All nonmetallic equipment and piping where an ignitable mixture could be present shall be given special consideration.

4.5.3.5 Electrical Installations. Design, selection, and installation of electrical wiring and electrical utilization equipment shall meet the requirements of Chapter 8.

4.5.4 Management of Fire Hazards. The extent of fire prevention and control provided for tank storage facilities shall be determined by an engineering evaluation of the installation and operation, followed by the application of sound fire protection and process engineering principles. The evaluation shall include, but not be limited to, the following:

- (1) Analysis of fire and explosion hazards of the facility
- (2) Analysis of local conditions, such as exposure to and from adjacent properties, flood potential, or earthquake potential
- (3) Fire department or mutual aid response

4.5.5 Fire Control. A fire-extinguishing system in accordance with an applicable NFPA standard shall be provided or shall be available for vertical atmospheric fixed-roof storage tanks larger than 190 m³ (50,000 gal or 1190 bbl) capacity, storing Class I liquids, if located in a congested area where there is an unusual exposure hazard to the tank from adjacent property or to adjacent property from the tank. Fixed-roof tanks storing Class II or III liquids at temperatures below their flash points and floating-roof tanks storing any liquid generally shall not require protection when installed in compliance with Section 4.3.

4.5.6 Emergency Planning and Training.

4.5.6.1 An emergency action plan, consistent with the available equipment and personnel, shall be established to respond to fire or other emergencies. This plan shall address the

Copyright NFPA

following:

- (1) Procedures to be used in case of fire, such as sounding the alarm, notifying the fire department, evacuating personnel, and controlling and extinguishing the fire
- (2) Appointment and training of persons to carry out fire safety duties
- (3) Maintenance of fire protection equipment
- (4) Holding fire drills
- (5) Shutdown or isolation of equipment to reduce the escape of liquid
- (6) Alternate measures for the safety of personnel while any fire protection equipment is shut down

4.5.6.2 Personnel responsible for the use and operation of fire protection equipment shall be trained in the use of that equipment. Refresher training shall be conducted at least annually. The personnel responsible shall be able to demonstrate knowledge of the use or operation of the fire protection equipment.

4.5.6.3 Planning of effective fire control measures shall be coordinated with local emergency response agencies. This planning shall include, but not be limited to, the identification of all tanks by location, contents, size, and hazard identification as required in 4.6.2.1.

4.5.6.4 Procedures shall be established to provide for safe shutdown of tank storage facilities under emergency conditions. Provisions shall be made for periodic training, inspection, and testing of associated alarms, interlocks, and controls.

4.5.6.5 The emergency procedures shall be kept readily available in an operating area and updated regularly.

4.5.6.6 Where premises are likely to be unattended for considerable periods of time, a summary of the emergency plan shall be posted or located in a strategic and accessible location.

4.5.7 Inspection and Maintenance.

4.5.7.1 All fire protection equipment shall be properly maintained and periodic inspections and tests shall be done in accordance with both standard practice and equipment manufacturer's recommendations.

4.5.7.2 Maintenance and operating practices at tank storage facilities shall control leakage and prevent spillage of liquids.

4.5.7.3 Ground areas around tank storage facilities shall be kept free of weeds, trash, or other unnecessary combustible materials.

4.5.7.4 Accessways established for movement of personnel shall be maintained clear of obstructions to permit orderly evacuation and ready access for manual fire fighting.

4.5.7.5 Combustible waste material and residues in operating areas shall be kept to a minimum, stored in covered metal containers, and disposed of daily.

4.6 Operations and Maintenance of Tanks.

4.6.1 Prevention of Overfilling of Tanks.

4.6.1.1 Aboveground tanks at terminals that receive and transfer Class I liquids from mainline pipelines or marine vessels shall follow formal written procedures to prevent overfilling of tanks utilizing one of the following methods of protection:

- (1) Tanks gauged at frequent intervals by personnel continuously on the premise during product receipt with frequent acknowledged communication maintained with the supplier so flow can be promptly shut down or diverted.
- (2) Tanks equipped with a high-level detection device that is independent of any gauging equipment. Alarm shall be located where personnel who are on duty throughout product transfer can promptly arrange for flow stoppage or diversion.
- (3) Tanks equipped with an independent high-level detection system that will automatically shut down or divert flow.
- (4) Alternatives to instrumentation described in 4.6.1.1(2) and 4.6.1.1(3) where approved by the authority having jurisdiction as affording equivalent protection.

4.6.1.2 Instrumentation systems covered in 4.6.1.1(2) and 4.6.1.1(3) shall be electrically supervised or equivalent.

4.6.1.3 Formal written procedures required by 4.6.1.1 shall include the following:

- (1) Instructions covering methods to check for proper lineup and receipt of initial delivery to tank designated to receive shipment.
- (2) Provision for training and monitoring the performance of operating personnel by terminal supervision.
- (3) Schedules and procedures for inspection and testing of gauging equipment and high-level instrumentation and related systems. Inspection and testing intervals shall be acceptable to the authority having jurisdiction but shall not exceed 1 year.

4.6.1.4 An underground tank shall be equipped with overfill prevention equipment that will operate as follows:

- (1) Automatically shut off the flow of liquid into the tank when the tank is no more than 95 percent full
- (2) Alert the transfer operator when the tank is no more than 90 percent full by restricting the flow of liquid into the tank or triggering the high-level alarm
- (3) Other methods approved by the authority having jurisdiction

4.6.1.5 Shop-fabricated aboveground atmospheric storage tanks, constructed to the recognized standards of 4.2.3.1 or approved equivalents, shall meet the requirements of 4.6.1.5.1 through 4.6.1.5.4 and 4.5.7 whenever the vertical length from the tank bottom to the top of the fill, normal vent, or emergency vent exceeds 3.7 m (12 ft).

4.6.1.5.1 An approved means shall be provided to promptly notify the tank filling operator of the pending completion of the tank fill operation at the fill connection.

4.6.1.5.2 An approved means shall be provided to stop delivery of liquid to the tank prior to the complete filling of the tank.

4.6.1.5.3 In no case shall these provisions restrict or interfere with the proper functioning of the normal vent or emergency vent.

4.6.1.5.4 The manufacturer of the tank shall be consulted to determine if reinforcement of the tank is required. If reinforcement is deemed necessary, it shall be done.

4.6.2 Identification and Security.

4.6.2.1 Emergency Response Identification. A sign or marking that meets the requirements of NFPA 704, *Standard System for the Identification of the Hazards of Materials for Emergency Response*, or an equivalent system, shall be applied to storage tanks containing liquids. The marking shall not need to be applied directly to the tank but shall be located where it can readily be seen, such as on the shoulder of an accessway or walkway to the tank or tanks or on the piping outside of the diked area. If more than one tank is involved, the markings shall be so located that each tank can readily be identified.

4.6.2.2 Unsupervised, isolated aboveground storage tanks shall be secured and marked in such a manner as to identify the fire hazards of the tank and the tank's contents to the general public. The area in which the tank is located shall be protected from tampering or trespassing, where necessary.

4.6.3 Tanks in Areas Subject to Flooding.

4.6.3.1 Water Loading. The filling of a tank to be protected by water loading shall be started as soon as floodwaters are predicted to reach a dangerous flood stage. Where independently fueled water pumps are relied upon, sufficient fuel shall be available at all times to permit continuing operations until all tanks are filled. Tank valves shall be locked in a closed position when water loading has been completed.

4.6.3.2 Operating Instructions. Operating instructions or procedures to be followed in a flood emergency shall be readily available.

4.6.3.3 Personnel Training. Personnel relied upon to carry out flood emergency procedures shall be informed of the location and operation of valves and other equipment necessary to effect the intent of these requirements.

4.6.4 Temporary or Permanent Removal from Service of Aboveground Tanks.

4.6.4.1* Closure of Storage Tanks. Aboveground tanks taken out of service or abandoned shall be emptied of liquid, rendered vapor-free, and safeguarded against trespassing.

4.6.4.2 Reuse of Aboveground Storage Tanks. Only those used tanks that comply with the applicable sections of this code and are approved by the authority having jurisdiction shall be installed for flammable or combustible liquids service.

4.6.5 Temporary or Permanent Removal from Service of Underground Tanks.

4.6.5.1 General. The procedures outlined in 4.6.5 shall be followed when taking underground tanks temporarily out of service, closing them in place permanently, or removing them. All applicable safety procedures associated with working in proximity to flammable and combustible materials shall be strictly adhered to. *(See Annex C for additional information.)*

4.6.5.2 Temporary Closure. Tanks shall be rendered temporarily out of service only when it is planned that they will be returned to active service, closed in place permanently, or removed within a reasonable period not exceeding 1 year. The following requirements shall be met:

- (1) Corrosion protection and release detection systems shall be maintained in operation.
- (2) The vent line shall be left open and functioning.
- (3) The tank shall be secured against tampering.
- (4) All other lines shall be capped or plugged.

4.6.5.3 Tanks remaining temporarily out of service for more than 1 year shall be permanently closed in place or removed in accordance with 4.6.5.4 or 4.6.5.5, as applicable.

4.6.5.4 Permanent Closure in Place. Tanks shall be permitted to be permanently closed in place if approved by the authority having jurisdiction. All of the following requirements shall be met:

- (1) All applicable authorities having jurisdiction shall be notified.
- (2)* A safe workplace shall be maintained throughout the prescribed activities.
- (3) All flammable and combustible liquids and residues shall be removed from the tank, appurtenances, and piping and shall be properly disposed of.
- (4) The tank shall be made safe by either purging it of flammable vapors or inerting the potential explosive atmosphere in the tank. Confirmation that the atmosphere in the tank is safe shall be by periodic testing of the atmosphere using a combustible gas indicator, if purging, or an oxygen meter, if inerting.
- (5) Access to the tank shall be made by careful excavation to the top of the tank.
- (6) All exposed piping, gauging and tank fixtures, and other appurtenances, except the vent, shall be disconnected and removed.
- (7) The tank shall be completely filled with an inert solid material.
- (8) The tank vent and remaining underground piping shall be capped or removed.
- (9) The tank excavation shall be backfilled.

4.6.5.5 Removal and Disposal. Underground tanks shall be removed in accordance with the following requirements:

- (1) The steps described in 4.6.5.4(1) through 4.6.5.4(5) shall be followed.
- (2) All exposed piping, gauging and tank fixtures, and other appurtenances, including the

vent, shall be disconnected and removed.

- (3) All openings shall be plugged, leaving a 6 mm (¼ in.) opening to avoid buildup of pressure in the tank.
- (4) The tank shall be removed from the excavated site and shall be secured against movement.
- (5) Any corrosion holes shall be plugged.
- (6) The tank shall be labeled with its former contents, present vapor state, vapor-freeing method, and a warning against reuse.
- (7) The tank shall be removed from the site promptly, preferably the same day.

4.6.5.6 Temporary Storage of Removed Tanks. If it is necessary to temporarily store a tank that has been removed, it shall be placed in a secure area where public access is restricted. A 6 mm (¼ in.) opening shall be maintained to avoid buildup of pressure in the tank.

4.6.5.7 Disposal of Tanks. Disposal of tanks shall meet the following requirements:

- (1) Before a tank is cut up for scrap or landfill, the atmosphere in the tank shall be tested in accordance with 4.6.5.4(4) to ensure that it is safe.
- (2) The tank shall be made unfit for further use by cutting holes in the tank heads and shell.

4.6.5.8 Documentation. All necessary documentation shall be prepared and maintained in accordance with all federal, state, and local rules and regulations.

4.6.5.9 Reuse of Underground Tanks. Only those used tanks that comply with the applicable sections of this code and are approved by the authority having jurisdiction shall be installed for flammable or combustible liquids service.

4.6.5.10 Change of Service of Underground Tanks. Tanks that undergo any change of stored product shall meet the requirements of Section 4.2.

4.6.6* Leak Detection and Inventory Records for Underground Tanks. Accurate inventory records or a leak detection program shall be maintained on all Class I liquid storage tanks for indication of possible leakage from the tanks or associated piping.

4.6.7 Tank Maintenance.

4.6.7.1* Each tank shall be inspected and maintained to ensure compliance with the requirements of this code. Testing requirements for tanks shall be in accordance with Section 4.4.

4.6.7.2 Each tank shall be maintained liquidtight. Each tank that is leaking shall be emptied of liquid or repaired in a manner acceptable to the authority having jurisdiction.

4.6.7.3 Tanks that have been structurally damaged, have been repaired or reconstructed, or are suspected of leaking shall be tested in accordance with 4.4.1 or in a manner acceptable to the authority having jurisdiction.

4.6.7.4* Tanks and all tank appurtenances, including normal vents and emergency vents and related devices, shall be properly maintained to ensure that they function as intended.

4.6.7.5 Openings for gauging on tanks storing Class I liquids shall be provided with a vaportight cap or cover. Such covers shall be closed when not gauging.

Chapter 5 Piping Systems

5.1 Scope.

5.1.1 This chapter shall apply to piping systems consisting of pipe, tubing, flanges, bolting, gaskets, valves, fittings, flexible connectors, the pressure-containing parts of other components such as expansion joints and strainers, and devices that serve such purposes as mixing, separating, snubbing, distributing, metering, controlling flow, or secondary containment of liquids and associated vapors.

5.1.2 This chapter shall not apply to any of the following:

- (1) Tubing or casing on any oil or gas wells and any piping connected directly thereto
- (2) Motor vehicles, aircraft, boats, or piping that are integral to a stationary engine assembly
- (3) Piping within the scope of any applicable boiler and pressure vessel code

5.2 General Requirements.

5.2.1 Performance Standards. The design, fabrication, assembly, test, and inspection of piping systems shall be suitable for the expected working pressures and structural stresses. Compliance with applicable sections of ASME B31, *Code for Pressure Piping*, and the provisions of this chapter shall be considered prima facie evidence of compliance with the foregoing provisions.

5.2.2 Tightness of Piping. Piping systems shall be maintained liquidtight. A piping system that has leaks that constitute a hazard shall be emptied of liquid or repaired in a manner acceptable to the authority having jurisdiction.

5.3 Materials for Piping Systems.

5.3.1 Material Specifications. Pipe, valves, faucets, couplings, flexible connectors, fittings, and other pressure-containing parts shall meet the material specifications and pressure and temperature limitations of ASME B31, *Code for Pressure Piping*, except as provided for in 5.3.2, 5.3.3, and 5.3.4.

5.3.2 Ductile Iron. Ductile (nodular) iron shall meet the specifications of ASTM A 395, *Ferritic Ductile Iron Pressure-Retaining Castings for Use at Elevated Temperatures*.

5.3.3 Materials of Construction of Valves. Valves at storage tanks, as required by 4.3.2.5.1 and 4.3.4.7.3, and their connections to the tank shall be of steel or ductile iron, except as provided for in 5.3.3.1, 5.3.3.2, or 5.3.4.

5.3.3.1 Valves at storage tanks shall be permitted to be other than steel or ductile iron where the chemical characteristics of the liquid stored are not compatible with steel or where the valves are installed internally to the tank. Valves installed externally to the tank shall be permitted to be other than steel or ductile iron if the material of construction has a ductility and melting point comparable to steel or ductile iron and is capable of withstanding the stresses and temperatures involved in fire exposure or the valves are otherwise protected from fire exposures, such as by materials having a fire resistance rating of not less than 2 hours.

5.3.3.2 Cast iron, brass, copper, aluminum, malleable iron, and similar materials shall be permitted to be used on tanks described in 4.3.2.2.1 or on tanks storing Class IIIB liquids where the tanks are located outdoors and not within a diked area or drainage path of a tank storing a Class I, Class II, or Class IIIA liquid.

5.3.4 Low Melting Point Materials. Low melting point materials such as aluminum, copper, and brass; materials that soften on fire exposure such as plastics; or nonductile material such as cast iron shall be permitted to be used underground within the pressure and temperature limitations of ASME B31, *Code for Pressure Piping*.

5.3.4.1 Such materials shall be permitted to be used outdoors above ground or inside buildings provided they meet one of the following conditions:

- (1) They are resistant to damage by fire.
- (2) They are located so that any leakage resulting from failure will not unduly expose persons, important buildings, or structures.
- (3) They are located where leakage can readily be controlled by operation of one or more accessible remotely located valves.

5.3.4.2 The piping materials chosen shall be compatible with the liquids being handled. Piping systems of these materials shall be designed and built in accordance with recognized standards of design for the particular materials chosen or with acceptable equivalent standards or shall be listed.

5.3.5 Lining Materials. Piping, valves, and fittings shall be permitted to have combustible or noncombustible linings.

5.3.6 Nonmetallic Piping. Piping systems of nonmetallic materials, including piping systems incorporating secondary containment, shall be designed and built in accordance with recognized standards of design or approved equivalents and shall be installed in accordance with 5.3.4. Nonmetallic piping shall be built and used within the scope of their approvals or within the scope of UL 971, *Standard for Nonmetallic Underground Piping for Flammable Liquids*. Nonmetallic piping systems and components shall be installed in accordance with manufacturer's instructions.

5.4 Pipe Joints.

5.4.1 Tightness of Pipe Joints. Joints shall be made liquidtight and shall be welded, flanged, threaded, or mechanically attached. They shall be designed and installed so that the

mechanical strength of the joint will not be impaired if exposed to a fire. Threaded joints shall be made with a suitable thread sealant or lubricant. Joints in piping systems handling Class I liquids shall be welded when located in concealed spaces within buildings.

5.4.2 Flexible Connectors. Listed flexible connectors shall be permitted to be used where installed in accordance with 5.4.3.

5.4.3 Friction Joints. Pipe joints dependent upon the friction characteristics or resiliency of combustible materials for mechanical continuity or liquidtightness of piping shall only be used outside of buildings above ground or below ground. Where used above ground, either the piping shall be secured to prevent disengagement at the fitting, or the piping system shall be so designed that any spill resulting from disengagement could not unduly expose persons, important buildings, or structures and could be readily controlled by remote valves.

Exception: Pipe joints that depend on friction characteristics of their components shall be permitted to be used inside buildings provided both of the following are met:

- (1) They are located where leakage can be readily controlled by operation of an accessible remotely located valve that is outside the fire risk area.*
- (2) The mechanical strength and liquidtightness of the joint is not dependent on the resiliency of a combustible material or component.*

5.5 Installation of Piping Systems.

5.5.1 General. Piping systems shall be substantially supported and protected against physical damage and excessive stresses arising from settlement, vibration, expansion, or contraction. The installation of nonmetallic piping shall be in accordance with the manufacturer's instructions.

5.5.2* Load-Bearing Supports. Load-bearing piping supports that are located in areas with a high fire exposure risk shall be protected by one or more of the following:

- (1) Drainage to a safe location to prevent liquid from accumulating under pipeways
- (2) Fire-resistive construction
- (3) Fire-resistant protective coatings or systems
- (4) Water spray systems designed and installed in accordance with NFPA 15, *Standard for Water Spray Fixed Systems for Fire Protection*
- (5) Other alternate means acceptable to the authority having jurisdiction

5.5.3 Pipe Penetrations. Piping that passes through or pierces a dike wall or the wall of a structure shall be designed to prevent excessive stresses and leakage due to settlement or fire exposure.

5.5.4* Protection Against Corrosion. Aboveground piping systems that are subject to external corrosion shall be suitably protected. Underground piping systems shall be protected against corrosion in accordance with 4.2.6.

5.5.5 Underground Piping.

5.5.5.1 Underground piping shall be installed on a bedding of at least 150 mm (6 in.) of well-compacted backfill material.

5.5.5.2 In areas subject to vehicle traffic, the pipe trench shall be of sufficient depth to permit a cover of at least 450 mm (18 in.) of well-compacted backfill material and pavement. In paved areas where a minimum 50 mm (2 in.) of asphalt is used, backfill between the pipe and the asphalt shall be permitted to be reduced to 200 mm (8 in.) minimum. In paved areas where a minimum 100 mm (4 in.) of reinforced concrete is used, backfill between the pipe and the asphalt shall be permitted to be reduced to 100 mm (4 in.) minimum.

5.5.5.3 In areas not subject to vehicle traffic, the pipe trench shall be of sufficient depth to permit a cover of at least 150 mm (6 in.) of well-compacted backfill material. A greater burial depth shall be provided when required by the manufacturer's instructions or where frost conditions are present.

5.5.5.4 Piping within the same trench shall be separated by two pipe diameters. Piping shall not need to be separated horizontally by more than 230 mm (9 in.).

5.5.5.5 Two or more levels of pipes within the same trench shall be separated vertically by a minimum 150 mm (6 in.) of well-compacted backfill.

5.5.6 Valves. Piping systems shall contain a sufficient number of valves to operate the system properly and to protect the equipment. Piping systems in connection with pumps shall contain a sufficient number of valves to properly control the flow of liquid both in normal operation and in the event of physical damage. Each connection to a piping system by which equipment such as tank cars, tank vehicles, or marine vessels discharges liquids into storage tanks shall be provided with a check valve for automatic protection against back-flow if the piping arrangement is such that back-flow from the system is possible. (*See also 4.3.2.5.1.*)

5.5.7 Common Loading and Unloading Piping. If loading and unloading is done through a common pipe system, a check valve shall not be required. However, an isolation valve shall be provided. This valve shall be located so that it is readily accessible or shall be remotely operable.

5.6 Testing.

5.6.1 Initial Testing. Unless tested in accordance with the applicable sections of ASME B31, *Code for Pressure Piping*, all piping shall be tested before being covered, enclosed, or placed in use. Testing shall be done hydrostatically to 150 percent of the maximum anticipated pressure of the system or pneumatically to 110 percent of the maximum anticipated pressure of the system, and the test pressure shall be maintained for a sufficient time to conduct a complete visual inspection of all joints and connections. In no case shall the test pressure be less than a gauge pressure of 35 kPa (5 psig) measured at the highest point of the system, and in no case shall the test pressure be maintained for less than 10 minutes.

5.6.2 Initial Testing of Secondary Containment Piping. The interstitial (annular) space of secondary containment-type piping shall be tested hydrostatically or with air pressure at a gauge pressure of 35 kPa (5 psig) or shall be tested in accordance with its listing or with the

manufacturer's instructions. The pressure source shall be disconnected from the interstitial space to ensure that the test is being conducted on a closed system. The pressure shall be maintained for a minimum of 1 hour.

5.6.3 Testing During Maintenance. Existing piping shall be tested in accordance with this subsection if there is indication that the piping is leaking. Piping that could contain a Class I, Class II, or Class IIIA liquid or vapor shall not be tested using air.

5.7 Vent Piping.

Vent piping shall be designed, constructed, and installed in accordance with Section 5.7.

5.7.1 Vent Piping for Aboveground Tanks.

5.7.1.1 Where the outlets of vent pipes for tanks storing Class I liquids are adjacent to buildings or public ways, they shall be located so that vapors are released at a safe point outside of buildings and not less than 3.6 m (12 ft) above the adjacent ground level. Vapors shall be discharged upward or horizontally away from adjacent walls. Vent outlets shall be located so that vapors will not be trapped by eaves or other obstructions and shall be at least 1.5 m (5 ft) from building openings.

5.7.1.2 Manifolding of vent piping shall be avoided except where required for special purposes such as vapor recovery, vapor conservation, or air pollution control. Where vent piping is manifolded, pipe sizes shall be capable of discharging, within the pressure limitations of the system, the vapors they are required to handle when all manifolded tanks are subject to the same fire exposure.

5.7.1.3 Vent piping for tanks storing Class I liquids shall not be manifolded with vent piping for tanks storing Class II or Class III liquids unless positive means are provided to prevent the following:

- (1) Vapors of Class I liquids from entering tanks storing Class II or Class III liquids
- (2) Contamination (*see A.1.2*)
- (3) Possible change in classification of the less volatile liquid

5.7.1.4* Extension of Emergency Vent Piping. Piping to or from approved emergency vent devices for atmospheric and low-pressure tanks shall be sized to provide emergency vent flows that limit the back pressure to less than the maximum pressure permitted by the design of the tank. Piping to or from approved emergency vent devices for pressure vessels shall be sized in accordance with the ASME *Boiler and Pressure Vessel Code*.

5.7.2 Vent Piping for Underground Tanks.

5.7.2.1 Vent pipes from underground tanks storing Class I liquids shall be located so that the discharge point is outside of buildings, higher than the fill pipe opening, and not less than 3.6 m (12 ft) above the adjacent ground level. Vent pipe outlets shall be located and directed so that vapors will not accumulate or travel to an unsafe location, enter building openings, or be trapped under eaves, and shall be at least 1.5 m (5 ft) from building openings and at least 4.5 m (15 ft) from powered ventilation air intake devices.

5.7.2.2 Vent pipes shall not be obstructed by devices provided for vapor recovery or other purposes unless the tank and associated piping and equipment are otherwise protected to limit back-pressure development to less than the maximum working pressure of the tank and equipment by the provision of pressure-vacuum vents, rupture discs, or other tank-venting devices installed in the tank vent lines. Vent outlets and devices shall be protected to minimize the possibility of blockage from weather, dirt, or insect nests.

5.7.2.3 Vent piping shall be sized in accordance with 4.2.5.3.

5.7.2.4 Vent pipes from tanks storing Class II or Class IIIA liquids shall terminate outside of the building and higher than the fill pipe opening. Vent outlets shall be above normal snow level. They shall be permitted to be fitted with return bends, coarse screens, or other devices to minimize ingress of foreign material.

5.7.2.5 Vent pipes and vapor return piping shall be installed without sags or traps in which liquid can collect. Condensate tanks, if utilized, shall be installed and maintained so that blocking of the vapor return piping by liquid is prevented. Vent pipes and condensate tanks shall be located so that they will not be subjected to physical damage. The tank end of the vent pipe shall enter the tank through the top.

5.7.2.6 Where tank vent piping is manifolded, pipe sizes shall be such as to discharge, within the pressure limitations of the system, the vapors they can be required to handle when manifolded tanks are filled simultaneously. Float-type check valves installed in tank openings connected to manifolded vent piping to prevent product contamination shall be permitted to be used provided that the tank pressure will not exceed that permitted by 4.3.3.2.3 when the valves close.

5.7.2.7 Vent piping for tanks storing Class I liquids shall not be manifolded with vent piping for tanks storing Class II or Class III liquids unless positive means are provided to prevent the following:

- (1) Vapors of Class I liquids from entering tanks storing Class II or Class III liquids
- (2) Contamination (*see A.1.2*)
- (3) Possible change in classification of the less volatile liquid

5.8 Static Electricity.

Piping systems shall be bonded and grounded in accordance with 4.5.3.4.

5.9* Identification.

Each loading and unloading riser shall be marked to identify the product for which it is to be used.

Chapter 6 Container and Portable Tank Storage

6.1 Scope.

Copyright NFPA

6.1.1 This chapter shall apply to the storage of liquids in drums or other containers that do not exceed 450 L (119 gal) individual capacity, in portable tanks that do not exceed 2500 L (660 gal) individual capacity, and in intermediate bulk containers that do not exceed 3000 L (793 gal) and to limited transfers incidental thereto. This chapter shall also apply to overpack drums when used for temporary containment of containers that do not exceed 230 L (60 gal) capacity. Such overpack containers shall be treated as containers as defined in 3.3.7.

6.1.2 This chapter shall not apply to the following:

- (1) Containers, intermediate bulk containers, and portable tanks that are used in process areas, as covered by Chapter 5
- (2) Liquids in the fuel tanks of motor vehicles, aircraft, boats, or portable or stationary engines
- (3) Beverages, where packaged in individual containers that do not exceed 5 L (1.3 gal) capacity
- (4) Medicines, foodstuffs, cosmetics, and other consumer products that contain not more than 50 percent by volume of water-miscible liquids, with the remainder of the solution not being flammable where packaged in individual containers that do not exceed 5 L (1.3 gal) capacity
- (5) Liquids that have no fire point when tested by ASTM D 92, *Standard Test Method for Flash and Fire Points by Cleveland Open Cup*, up to the boiling point of the liquid or up to a temperature at which the sample being tested shows an obvious physical change
- (6) Liquids with a flash point greater than 35°C (95°F) in a water-miscible solution or in dispersion with a water and inert (noncombustible) solids content of more than 80 percent by weight, which do not sustain combustion when tested using the “Method of Testing for Sustained Combustibility,” per 49 CFR 173, Appendix H, or the UN *Recommendations on the Transport of Dangerous Goods*
- (7) Distilled spirits and wines in wooden barrels or casks

6.1.3 General Provisions.

6.1.3.1 For the purpose of this chapter, unstable liquids shall be treated as Class IA liquids.

6.1.3.2 For the purposes of this chapter, protected storage installed after January 1, 1997, shall mean storage installed after January 1, 1997 that is protected in accordance with Section 6.8. All other storage shall be considered to be unprotected storage unless an alternate means of protection has been approved by the authority having jurisdiction. (*See 6.8.2.4 and 6.8.3.*)

Exception: As provided for in Section 6.5.

6.2 Design, Construction, and Capacity of Containers.

6.2.1 Only the following approved containers, intermediate bulk containers, and portable tanks shall be used:

Copyright NFPA

- (1) Metal containers, metal intermediate bulk containers, and metal portable tanks meeting the requirements of, and containing products authorized by, the U. S. Department of Transportation Hazardous Materials Regulations, 49 CFR or by Part 6 of the UN *Recommendations on the Transport of Dangerous Goods* shall be acceptable.
- (2) Plastic containers meeting the requirements of, and used for petroleum products within the scope of, one or more of the following specifications shall be acceptable:
 - (a) ASTM F 852, *Standard for Portable Gasoline Containers for Consumer Use*
 - (b) ASTM F 976, *Standard for Portable Kerosene Containers for Consumer Use*
 - (c) ANSI/UL 1313, *Nonmetallic Safety Cans for Petroleum Products*
- (3) Plastic containers meeting the requirements of and containing products authorized by the U. S. Department of Transportation Hazardous Materials Regulations, 49 CFR or by Part 6 of the UN *Recommendations on the Transport of Dangerous Goods* shall be acceptable.
- (4) Fiber drums that meet the following shall be acceptable:
 - (a) Requirements of Item 296 of the *National Motor Freight Classification* (NMFC) or Rule 51 of the *Uniform Freight Classification* (UFC) for Types 2A, 3A, 3B-H, 3B-L, or 4A
 - (b) Requirements of, and containing liquid products authorized by, either the U. S. Department of Transportation Hazardous Materials Regulations, 49 CFR Chapter I, 49 CFR or U.S. Department of Transportation exemption
- (5)* Rigid nonmetallic intermediate bulk containers that meet the requirements of and containing products authorized by the U. S. Department of Transportation Hazardous Materials Regulations, 49 CFR, or by Part 6 of the UN *Recommendations on the Transport of Dangerous Goods* for Classes 31H1, 31H2, and 31HZ1 shall be acceptable. For protected storage, rigid nonmetallic intermediate bulk containers shall be subjected to a standard fire test that demonstrates acceptable inside storage fire performance and shall be listed and labeled.

6.2.2 Each portable tank or intermediate bulk container shall be provided with one or more devices installed in the top with sufficient emergency venting capacity to limit internal pressure under fire exposure conditions to a gauge pressure of 70 kPa (10 psig) or 30 percent of the bursting pressure of the portable tank, whichever is greater. The total venting capacity shall be not less than that specified in 4.2.5.2.3 or 4.2.5.2.5. At least one pressure-actuated vent having a minimum capacity of 170 m³ (6000 ft³) of free air per hour at 1 bar (14.7 psia) and 15.6°C (60°F) shall be used. It shall be set to open at not less than a gauge pressure of 35 kPa (5 psig). If fusible vents are used, they shall be actuated by elements that operate at a temperature not exceeding 150°C (300°F). Where plugging of a pressure-actuated vent can occur, such as when used for paints, drying oils, and similar materials, fusible plugs or venting devices that soften to failure at a maximum of 150°C (300°F) under fire exposure shall be permitted to be used for the entire emergency venting

requirement.

6.2.3 The maximum allowable size of a container or metal portable tank shall not exceed that specified in Table 6.2.3.

Type	Flammable Liquids			Combustible
	Class IA	Class IB	Class IC	Class II
Glass	0.5 L (1.05 pt)	1 L (1.05 qt)	5 L (1.3 gal)	5 L (1.3 gal)
Metal (other than drums) or approved plastic	5 L (1.3 gal)	20 L (5.3 gal)	20 L (5.3 gal)	20 L (5.3 gal)
Safety cans	10 L (2.6 gal)	20 L (5.3 gal)	20 L (5.3 gal)	20 L (5.3 gal)
Metal drum (e.g., UN 1A1 or 1A2)	450 L (119 gal)	450 L (119 gal)	450 L (119 gal)	450 L (119 gal)
Approved metal portable tanks and IBCs	3000 L (793 gal)	3000 L (793 gal)	3000 L (793 gal)	3000 L (793 gal)
Rigid plastic IBCs (UN 31H1 or 31H2) and composite IBCs with rigid inner receptacle (UN31HZ1)	NP	NP	NP	3000 L (793 gal)
Composite IBCs with flexible inner receptacle (UN31HZ2) and flexible IBCs (UN13H, UN13L, and UN13M)	NP	NP	NP	NP
Bag-in-Box Nonbulk	NP	NP	NP	NP
Polyethylene UN 1H1, or as authorized by DOT exemption	5 L (1.3 gal)	20 L (5.3 gal) [†]	20 L (5.3 gal) [†]	450 L (119 gal)
Fiber drum NMFC or UFC Type 2A; Types 3A, 3B-H, or 3B-L; or Type 4A	NP	NP	NP	450 L (119 gal)
Note: NP — Not permitted.				
[†] For Class IB and IC water-miscible liquids, the maximum allowable size of plastic container is 230 L (60 gal) protected in accordance with Table 6.8.2(g).				

Exception: As provided for in Section 6.1, 6.2.3.1, 6.2.3.2, and 6.2.3.3.

6.2.3.1 Medicines, beverages, foodstuffs, cosmetics, and other common consumer products, where packaged according to commonly accepted practices for retail sales, shall be exempt from the requirements of 6.2.1 and 6.2.3.

6.2.3.2 Class IA and Class IB liquids shall be permitted to be stored in glass containers of not more than 5 L (1.3 gal) capacity, if the required liquid purity (such as ACS analytical reagent grade or higher) would be affected by storage in metal containers or if the liquid can cause excessive corrosion of the metal container.

6.2.3.3 Leaking or damaged containers up to 230 L (60 gal) capacity shall be permitted to be stored temporarily in accordance with this chapter, provided they are enclosed in overpack containers. To be considered protected in accordance with Section 6.8, the overpack container shall be constructed of the same material as the leaking or damaged container. Metal overpack containers shall be considered nonrelieving containers.

6.3 Design, Construction, and Capacity of Storage Cabinets.

6.3.1 The volume of Class I, Class II, and Class IIIA liquids stored in a storage cabinet shall not exceed 454 L (120 gal).

6.3.2 The number of storage cabinets located in any one fire area shall not exceed three.

Exception No. 1: In an industrial occupancy, additional storage cabinets, in groups of not more than three cabinets, shall be permitted to be located in the same fire area, if a minimum separation of 30 m (100 ft) is maintained between each group.

Exception No. 2: In an industrial occupancy that is protected by an automatic sprinkler system that is designed and installed in accordance with NFPA 13, Standard for the Installation of Sprinkler Systems, the number of cabinets in any one group shall be permitted to be increased to six.

6.3.3 Storage cabinets that meet at least one of the following sets of requirements shall be acceptable for storage of liquids:

- (1) Storage cabinets that are designed and constructed to limit the internal temperature at the center of the cabinet and 25 mm (1 in.) from the top of the cabinet to not more than 163°C (325°F), when subjected to a 10-minute fire test that simulates the fire exposure of the standard time–temperature curve specified in NFPA 251, *Standard Methods of Tests of Fire Endurance of Building Construction and Materials*, shall be acceptable. All joints and seams shall remain tight and the door shall remain securely closed during the test.
- (2) Metal storage cabinets that are constructed in the following manner shall be acceptable:
 - (a) The bottom, top, door, and sides of the cabinet shall be at least No. 18 gauge sheet steel and shall be double-walled, with 38 mm (1½ in.) air space.
 - (b) Joints shall be riveted, welded, or made tight by some equally effective means.
 - (c) The door shall be provided with a three-point latch arrangement, and the door sill shall be raised at least 50 mm (2 in.) above the bottom of the cabinet to retain spilled liquid within the cabinet.
- (3) Wooden cabinets constructed in the following manner shall be acceptable:

- (a) The bottom, sides, and top shall be constructed of exterior grade plywood that is at least 25 mm (1 in.) thick and of a type that will not break down or delaminate under fire conditions.
 - (b) All joints shall be rabbetted and shall be fastened in two directions with wood screws. Where more than one door is used, there shall be a rabbetted overlap of not less than 25 mm (1 in.).
 - (c) Doors shall be equipped with a means of latching and hinges shall be constructed and mounted in such a manner as to not lose their holding capacity when subjected to fire exposure.
 - (d) A raised sill or pan capable of containing a 50 mm (2 in.) depth of liquid shall be provided at the bottom of the cabinet to retain spilled liquid within the cabinet.
- (4) Listed storage cabinets that have been constructed and tested in accordance with 6.3.3(1) shall be acceptable.

6.3.4* The storage cabinet shall not be required by this code to be vented for fire protection purposes, and vent openings shall be sealed with the bungs supplied with the cabinet or with bungs specified by the cabinet manufacturer. However, if the storage cabinet is vented for any reason, the cabinet shall be vented directly to outdoors in such a manner that will not compromise the specified performance of the cabinet and in a manner that is acceptable to the authority having jurisdiction.

6.3.5 Storage cabinets shall be marked in conspicuous lettering:

FLAMMABLE — KEEP FIRE AWAY.

6.4* Design, Construction, and Operation of Inside Liquid Storage Areas.

6.4.1 Scope. Section 6.4 shall apply to inside areas where the primary function is the storage of liquids. This shall include inside rooms, cutoff rooms, attached buildings, liquid warehouses, and hazardous material storage lockers that are used as inside storage areas. *(See Section 6.5 for storage of liquids in other types of occupancies.)*

6.4.2 Design and Construction Requirements.

6.4.2.1 All storage areas shall be constructed to meet the specified fire resistance ratings in Table 6.4.2.1. Such construction shall comply with the test specifications given in NFPA 251, *Standard Methods of Tests of Fire Endurance of Building Construction and Materials*.

Table 6.4.2.1 Fire Resistance Ratings for Inside Liquid Storage Areas

Type of Storage Area	Fire Resistance Rating (hr)		
	Interior Walls, ^a Ceilings, Intermediate Floors	Roofs	Exterior Walls

Table 6.4.2.1 Fire Resistance Ratings for Inside Liquid Storage Areas

Type of Storage Area	Fire Resistance Rating (hr)		
	Interior Walls, ^a Ceilings, Intermediate Floors	Roofs	Exterior Walls
Inside rooms			
Floor area ≤ 150 ft ²	1	—	—
Floor area >150 ft ² and ≤ 500 ft ²	2	—	—
Cutoff rooms and attached buildings			
Floor area ≤ 300 ft ²	1	1 ^b	—
Floor area >300 ft ²	2	2 ^b	2 ^c
Liquid warehouses ^{d,e}	4 ^f	—	2 ^g or 4 ^h

Note: For SI units, 1 ft² = 0.09 m².

^aBetween liquid storage areas and any adjacent areas not dedicated to liquid storage.

^bRoofs of attached buildings, one story in height, shall be permitted to be of lightweight, noncombustible construction if the separating interior walls have minimum 0.9 m (3 ft) parapets.

^cWhere other portions of buildings or other properties are exposed.

^dFire resistance ratings for liquid warehouses storing only Class IIIB liquids, which are not heated above their flash point, shall be permitted to be reduced to 2 hours.

^eFire resistance ratings for liquid warehouses protected in accordance with 6.8.2 shall be permitted to be reduced to 2 hours.

^fThis shall be a fire wall as defined in NFPA 221, *Standard for Fire Walls and Fire Barrier Walls*.

^gFor exposing walls that are located more than 3 m (10 ft) but less than 15 m (50 ft) from an important building or line of adjoining property that can be built upon.

^hFor exposing walls that are located 3 m (10 ft) or less from an important building or line of adjoining property that can be built upon.

6.4.2.2 Openings in interior walls to adjacent rooms or buildings and openings in exterior walls with fire resistance ratings shall be provided with normally closed, listed fire doors with fire protection ratings corresponding to the fire resistance rating of the wall as specified in Table 6.4.2.2. Such doors shall be permitted to be arranged to stay open during material handling operations if the doors are designed to close automatically in a fire emergency by provision of listed closure devices. Fire doors shall be installed in accordance with NFPA 80,

6.4.2.2 Openings in interior walls to adjacent rooms or buildings and openings in exterior walls with fire resistance ratings shall be provided with normally closed, listed fire doors with fire protection ratings corresponding to the fire resistance rating of the wall as specified in Table 6.4.2.2. Such doors shall be permitted to be arranged to stay open during material handling operations if the doors are designed to close automatically in a fire emergency by provision of listed closure devices. Fire doors shall be installed in accordance with NFPA 80, *Standard for Fire Doors and Fire Windows*.

**Table 6.4.2.2 Fire Protection Ratings
for Fire Doors**

Fire Resistance Rating of Wall^a (hr)	Fire Protection Rating of Door (hr)
1	$\frac{3}{4}$
2	1½
4	3 ^b

^aAs required by Table 6.4.2.1.

^bOne fire door required on each side of interior openings for attached liquid warehouses.

6.4.2.3 Exterior walls shall be constructed to provide ready access for fire-fighting operations by means of access openings, windows, or lightweight noncombustible wall panels.

Exception: This shall not apply to inside rooms.

6.4.2.4* Where Class IA liquids or unstable liquids are dispensed or stored in containers larger than 1 L (1 gal), rooms shall be designed to direct flame, combustion gases and pressures resulting from a deflagration away from important buildings or occupied areas through the use of damage-limiting construction. The damage-limiting construction design shall be in accordance with recognized engineering standards and shall be acceptable to the authority having jurisdiction.

Exception: This shall not apply to inside rooms.

6.4.2.5* Curbs, scuppers, special drains, or other suitable means shall be provided to prevent the flow of liquids under emergency conditions into adjacent building areas. If a drainage system is used, it shall have sufficient capacity to carry the expected discharge of water from fire protection systems and hose streams.

Exception No. 1: Where none of the containers stored in a storage area exceed 38 L (10 gal), the storage area need not meet this requirement.

Exception No. 2: Where only Class IIIB liquids are stored in a storage area, regardless of container size, the storage area need not meet this requirement.

Exception No. 3: Where unsaturated polyester resins (UPRs) containing not more than 50 percent by weight of Class IC, Class II, or Class IIIA liquid constituents are protected in accordance with Table 6.8.2(k), the storage area need not meet this requirement.

6.4.2.6 In inside storage rooms, electrical wiring and utilization equipment for Class I liquid storage shall be Class I, Division 2, and electrical wiring and utilization equipment in inside storage rooms used for the storage of Class II and Class III liquids shall be suitable for general purpose.

Exception: Class I, Division 2 requirements shall apply to Class II and III liquids when stored at temperatures above their flash points.

6.4.2.6.1 Installation of electrical wiring and utilization equipment shall meet the requirements of Chapter 8.

6.4.2.7 Liquid storage areas where dispensing is conducted shall be provided with either a gravity or a continuous mechanical exhaust ventilation system. Mechanical ventilation shall be used if Class I liquids are dispensed within the room.

6.4.2.7.1 Exhaust air shall be taken from a point near a wall on one side of the room and within 300 mm (12 in.) of the floor, with one or more make-up inlets located on the opposite side of the room within 300 mm (12 in.) of the floor. The location of both the exhaust and inlet air openings shall be arranged to provide, as far as practicable, air movements across all portions of the floor to prevent accumulation of flammable vapors. Exhaust from the room

Copyright NFPA

shall be directly to the exterior of the building without recirculation.

Exception: Recirculation is permitted where it is monitored continuously using a fail-safe system that is designed to automatically sound an alarm, stop recirculation, and provide full exhaust to the outside in the event that vapor–air mixtures in concentrations over one-fourth of the lower flammable limit are detected.

6.4.2.7.1.1 If ducts are used, they shall not be used for any other purpose and shall comply with NFPA 91, *Standard for Exhaust Systems for Air Conveying of Vapors, Gases, Mists, and Noncombustible Particulate Solids*. If make-up air to a mechanical system is taken from within the building, the opening shall be equipped with a fire door or damper, as required in NFPA 91. For gravity systems, the make-up air shall be supplied from outside the building.

6.4.2.7.2 Mechanical ventilation systems shall provide at least 0.3 m³/min of exhaust air for each m² of floor area (1 cfm/ft²), but not less than 4 m³/min (150 cfm). The mechanical ventilation system for dispensing areas shall be equipped with an airflow switch or other equally reliable method that is interlocked to sound an audible alarm upon failure of the ventilation system.

6.4.3 General Storage Requirements.

6.4.3.1 The storage of any liquids shall not physically obstruct means of egress.

6.4.3.2 Wood at least 25 mm (1 in.) nominal thickness shall be permitted to be used for shelving, racks, dunnage, scuffboards, floor overlay, and similar installations.

6.4.3.3 Where storage on racks exists as permitted in this code, a minimum 1.2 m (4 ft) wide aisle shall be provided between adjacent rack sections and any adjacent storage of liquids. Main aisles shall be a minimum of 2.4 m (8 ft) wide.

6.4.3.4 Solid pile and palletized storage in liquid warehouses shall be arranged so that piles are separated from each other by at least 1.2 m (4 ft). Aisles shall be provided and arranged so that no container or portable tank is more than 6 m (20 ft) from an aisle. Main aisles shall be a minimum of 2.4 m (8 ft) wide.

Exception: For Class IIIB liquids in containers, the distance between piles shall be permitted to be reduced from 1.2 m (4 ft) to 0.6 m (2 ft) in proportion to commensurate reductions in maximum quantity per pile and maximum storage height, as given in the table in 6.4.4.1.

6.4.3.5 Class I liquids shall not be permitted in basement areas. Class II and Class IIIA liquids shall be permitted to be stored in basements provided that automatic sprinkler protection and other fire protection facilities are provided in accordance with Section 6.8.

6.4.3.6 Limited quantities of combustible commodities, as defined in the scope of NFPA 230, *Standard for the Fire Protection of Storage*, shall be permitted to be stored in liquid storage areas if the ordinary combustibles, other than those used for packaging the liquids, are separated from the liquids in storage by a minimum of 2.4 m (8 ft) horizontally, either by aisles or by open racks, and if protection is provided in accordance with Section 6.8.

6.4.3.7 Storage of empty or idle combustible pallets inside an unprotected liquid storage

area shall be limited to a maximum pile size of 230 m² (2500 ft²) and to a maximum storage height of 1.8 m (6 ft). Storage of empty or idle combustible pallets inside a protected liquid storage area shall comply with NFPA 230, *Standard for the Fire Protection of Storage*. Pallet storage shall be separated from liquid storage by aisles that are at least 2.4 m (8 ft) wide.

6.4.3.8 Containers in piles shall be stacked in such a manner as to provide stability and to prevent excessive stress on container walls. Portable tanks stored over one tier high shall be designed to nest securely, without dunnage. Materials handling equipment shall be suitable to handle containers and tanks safely at the upper tier level.

6.4.3.9 Containers or portable tanks in unprotected liquid storage areas shall not be stored closer than 914 mm (36 in.) to the nearest beam, chord, girder, or other roof member.

6.4.4 Allowable Quantities and Storage Heights.

6.4.4.1* Except as provided for in 6.4.3.4 and in 6.4.4.2 through 6.4.4.4, indoor unprotected liquid storage shall comply with Table 6.4.4.1. Where storage of liquids is protected as defined in 6.1.3.2, the protection shall meet the requirements of Section 6.8.

Table 6.4.4.1 Indoor Unprotected Storage of Liquids in Containers, Portable Tanks, &

Class	Container Storage			Portable Tank/Metallic IBC Storage		
	Maximum Pile Height (ft)	Maximum Quantity per Pile (gal)	Maximum Total Quantity (gal) [†]	Pile Maximum Height (ft)	Maximum Quantity per Pile (gal)	Maximum Total Quantity (gal) [†]
IA	5	660	660	—	NP	—
IB	5	1,375	1,375	7	2,000	2,000
IC	5	2,750	2,750	7	4,000	4,000
II	10	4,125	8,250	7	5,500	11,000
IIIA	15	13,750	27,500	7	22,000	44,000
IIIB	15	13,750	55,000	7	22,000	88,000

Notes:

(1) For SI units, 1 ft = 0.3 m; 1 gal = 3.8 L.

(2) NP — Not permitted.

[†]Applies only to cut-off rooms and attached buildings, not to liquid warehouses.

Exception: Other quantities and arrangements of storage shall be permitted to be used where the storage is suitably protected and approved by the authority having jurisdiction.

6.4.4.2 Storage in inside rooms shall meet the requirements specified in Table 6.4.4.2. In addition, containers over 114 L (30 gal) capacity that contain Class I or Class II liquids shall not be stored more than one container high in inside rooms.

Table 6.4.4.2 Storage Limitations for Inside Rooms

6.4.4.2 Storage in inside rooms shall meet the requirements specified in Table 6.4.4.2. In addition, containers over 114 L (30 gal) capacity that contain Class I or Class II liquids shall not be stored more than one container high in inside rooms.

Table 6.4.4.2 Storage Limitations for Inside Rooms

Total Floor Area (ft ²)	Automatic Fire Protection Provided? ^a	Total Allowable Quantity (gal/ft ² of floor area)
≤ 150	No	2
	Yes	5
>150 and ≤ 500	No	4 ^b
	Yes	10

Note: For SI units, 1 ft² = 0.09 m²; 1 gal = 3.8 L.

^aThe fire protection system shall be automatic sprinklers, water spray, carbon dioxide, dry chemical, or other approved system. (See Section 6.8.)

^bTotal allowable quantities of Class IA and IB liquids shall not exceed the quantities permitted in Table 6.4.4.1 or those permitted by 6.4.4.4.

Exception: This requirement shall not apply to inside rooms and hazardous materials storage lockers that are located in a liquid warehouse and are provided with equal or greater fire protection as is provided for the warehouse itself.

6.4.4.3 Unprotected storage of liquids in racks shall not exceed the maximum total quantities allowed by Table 6.4.4.1.

Exception: Liquid warehouses do not need to comply with this requirement.

6.4.4.4 The total quantity of liquids stored in a liquid warehouse shall not be restricted. However, the storage heights and maximum quantity per pile or rack section for unprotected storage shall comply with Table 6.4.4.1.

Exception: An unprotected liquid warehouse that is located a minimum of 30 m (100 ft) from exposed buildings or any property line that is or can be built upon does not need to comply with 6.4.3.9 and Table 6.4.4.1 if there is protection for exposures. Where protection for exposures is not provided, this minimum distance shall be increased to 60 m (200 ft).

6.4.4.5 Where two or more classes of liquids are stored in a single pile or rack section, the maximum total quantity and the maximum storage height permitted in that pile or rack section shall be the smallest of the individual maximum total quantities and maximum storage heights for the specific classes present, respectively. The maximum total quantity permitted shall be limited to a sum of the proportional amounts that each class of liquid present bears to the maximum total quantity permitted for its respective class. The sum of the proportional amounts shall not exceed 100 percent.

Exception: The maximum total quantities in liquid warehouses shall not be restricted. (See also 6.4.4.3.)

6.4.5 Operations.

6.4.5.1 Dispensing of Class I liquids or Class II or Class III liquids at temperatures at or above their flash points shall not be permitted in cutoff rooms or attached buildings that exceed 93 m² (1000 ft²) in floor area or in liquid warehouses unless the dispensing area is suitably cut off from the storage areas in accordance with Table 6.4.2.1 and meets all other requirements of 6.4.2.

6.4.5.2 Dispensing operations shall comply with the applicable requirements of Chapter 7.

6.5 Requirements for Liquid Storage Areas in Other Occupancies.

6.5.1 Scope. Section 6.5 shall apply to areas where the storage of liquids is incidental and not the primary purpose of the area.

Exception: See Chapter 7 for incidental storage of liquids used in processing, blending, and packaging areas, including areas where liquids in containers are staged after filling and prior to further use, warehousing, or shipment.

6.5.1.1 Where inside liquid storage areas are required in other occupancies, they shall meet all applicable requirements of Section 6.4 and all applicable requirements of Section 6.5. Where other factors substantially increase or decrease the hazard, the authority having jurisdiction shall be permitted to modify the quantities specified.

6.5.1.2 Storage of liquids shall not physically obstruct a means of egress. Class I liquids shall be placed so that a fire in the liquid storage area would not prevent egress from the area.

6.5.1.3 Liquids used for building maintenance, painting, or other similar infrequent maintenance purposes shall be permitted to be stored temporarily in closed containers outside of storage cabinets or inside liquid storage areas, if limited to an amount that does not exceed a 10-day supply at anticipated rates of use.

6.5.1.4 Class I liquids shall not be stored in basements.

6.5.2 General-Purpose Warehouses.

6.5.2.1 General. General-purpose warehouses, as defined in 3.3.49.1, that store liquids shall be separate, detached buildings or shall be separated from other occupancies by a 4-hour fire wall as defined in NFPA 221, *Standard for Fire Walls and Fire Barrier Walls*, or, if approved, by a fire partition having a fire resistance rating of not less than 2 hours. Each opening shall be protected as provided for in 6.4.2.2.

6.5.2.2 Operations Involving Storage of Liquids. Warehousing operations that involve storage of liquids shall be restricted to inside liquid storage areas in accordance with Section 6.4.

Exception: As provided for in 6.5.2.3.

6.5.2.3 Basic Requirements. Class IB and IC liquids in containers of 5 L (1.3 gal) or less

capacity, Class II liquids in containers of 20 L (5.3 L) or less capacity, and Class III liquids in containers of 230 L (60 gal) or less capacity shall be permitted to be stored in warehouses that handle combustible commodities, as defined in NFPA 13, *Standard for the Installation of Sprinkler Systems*, provided that the storage area is protected with automatic sprinklers in accordance with the provisions of NFPA 13 for 20 ft (6 m) high storage of Class IV commodities and the quantities and height of liquid storage are limited to the following:

- (1) Class IA liquids: not permitted
- (2) Class IB and IC liquids: 2500 L (660 gal), maximum 1.5 m (5 ft) high pile stored on floor, with no rack or other storage above
- (3) Class II liquid: 5200 L (1375 gal), maximum 1.5 m (5 ft) high pile stored on floor, with no rack or other storage above
- (4) Class IIIA liquid: 10,400 L (2750 gal), maximum 3 m (10 ft) high pile stored on floor, with no rack or other storage above or in storage racks to a maximum height of 3 m (10 ft)
- (5) Class IIIB liquid: 52,000 L (13,750 gal), maximum 4.6 m (15 ft) high pile stored on floor, with no rack or other storage above or in storage racks to a maximum height of 4.6 m (15 ft)

6.5.2.3.1 The liquid storage shall also comply with 6.5.2.3 through 6.5.2.9.

6.5.2.4* Liquids in Plastic Containers. Class I and Class II liquids in plastic containers shall not be stored in general-purpose warehouses but shall be stored in inside liquid storage areas that meet the requirements of Section 6.4.

Exception No. 1: The following liquids, packaged in plastic containers, shall be permitted to be stored in general-purpose warehouses in accordance with the protection and storage limitations specified in 6.5.2 as follows:

- (1) *Products containing not more than 50 percent by volume of water-miscible liquids, with the remainder of the solution not being a Class I liquid, where packaged in individual containers*
- (2) *Products containing more than 50 percent water-miscible liquids in individual containers not exceeding 0.5 L (16 oz) capacity in cartons*

Exception No. 2: Class I and Class II liquids in plastic containers shall be permitted to be stored in a general-purpose warehouse if the packaging systems are listed and labeled for use with these materials. All other provisions of 6.5.2 shall also apply.

6.5.2.5 Palletized, Solid Pile, or Rack Storage. Liquids in containers shall be permitted to be stored on pallets, in solid piles, or on racks, subject to the maximum total quantity and maximum storage height provisions of 6.5.2.3.

6.5.2.6 Basement Storage Areas. Storage of liquids in basement areas of general-purpose warehouses shall only be permitted as provided for in 6.4.3.5.

6.5.2.7 Mixed Liquid Storage. Where two or more classes of liquids are stored in a single pile or single rack section, the maximum total quantity and maximum storage height

permitted shall be as provided for in 6.4.4.5.

6.5.2.8 Separation and Aisles. Storage of liquids in general-purpose warehouses shall be arranged as provided for in 6.4.3.3 and 6.4.3.4.

6.5.2.9 Liquids and Ordinary Combustible Storage. The following shall apply to the storage of liquids and ordinary combustible commodities:

- (1) Liquids shall not be stored in the same pile or in the same rack sections as ordinary combustible commodities [see 6.5.2.9(2)]. Where liquids are packaged together with ordinary combustibles, as in kits, the storage shall be considered on the basis of whichever commodity predominates.
- (2) Except as provided for in 6.5.2.9(1), ordinary combustible commodities shall be separated from liquids in containers by a minimum distance of 2.4 m (8 ft).

6.5.2.10 Operations. Dispensing of Class I and Class II liquids in general-purpose warehouses shall not be permitted unless the dispensing area is suitably cut off from other ordinary combustible or liquid storage areas, as specified in 6.4.2, and otherwise complies with the applicable provisions of 6.4.2.

6.5.3 Dwellings and Residential Buildings Containing Not More than Three Dwelling Units and Accompanying Attached and Detached Garages. Storage in excess of 95 L (25 gal) of Class I and Class II liquids combined shall be prohibited. In addition, storage in excess of 230 L (60 gal) of Class IIIA liquid shall be prohibited.

6.5.4 Assembly Occupancies, Buildings Containing More than Three Dwelling Units, and Hotels. Storage in excess of 38 L (10 gal) of Class I and Class II liquids combined or 230 L (60 gal) of Class IIIA liquids shall be in containers stored in storage cabinets, in safety cans, or in an inside storage area that does not have openings that communicate with that portion of the building used by the public.

6.5.5 Office, Educational, and Institutional Occupancies, and Day Care Centers. The requirements of 6.5.5.1 through 6.5.5.5 shall apply to office, educational, and institutional occupancies and day care centers.

6.5.5.1 Storage shall be limited to that required for operation of office equipment, maintenance, demonstration, and laboratory work. This storage shall comply with the provisions of 6.5.5.2 through 6.5.5.5, except that the storage for industrial and educational laboratory work shall comply with NFPA 45, *Standard on Fire Protection for Laboratories Using Chemicals*.

6.5.5.2 Containers of Class I liquids that are stored outside of an inside liquid storage area shall not exceed a capacity of 5 L (1.3 gal).

Exception: Safety cans shall be permitted up to a 10 L (2.6 gal) capacity.

6.5.5.3 The combined volume of Class I and Class II liquids stored in a single fire area outside of a storage cabinet or an inside liquid storage area not stored in safety cans shall not exceed 38 L (10 gal).

6.5.5.4 The combined volume of Class I and Class II liquids stored in a single fire area in

safety cans outside of an inside liquid storage area or storage cabinet shall not exceed 95 L (25 gal).

6.5.5.5 The volume of Class IIIA liquids stored outside of an inside liquid storage area or storage cabinet shall not exceed 230 L (60 gal).

6.5.6 Mercantile Occupancies.

6.5.6.1 Subsection 6.5.6 shall apply to mercantile occupancies that handle, store, and display liquids, as defined in this code.

6.5.6.2 The display arrangement, storage arrangement, and maximum total quantity of liquids allowed shall meet the requirements of this subsection and Table 6.5.6.2.

Table 6.5.6.2 Allowable Storage and Display Amounts for Mercantile Occupancies

Level of Protection	Storage Limits	Liquid Classification	
		IA ¹	IB, IC, II, and IIIA (Any Combination)
Unprotected	Maximum quantity allowed ³	60 gal	3750 gal per building area; a maximum of 10 areas permitted per occupancy when separated by a minimum 1-hour-rated fire separation wall
	Maximum storage density		2 gal/ft ² in storage or display areas and adjacent aisles
NFPA 13, Ordinary Hazard (Group 2) Sprinkler System ²	Maximum quantity allowed ³	120 gal	7500 gal per building area; a maximum of 10 areas permitted per occupancy when separated by a minimum 1-hour-rated fire separation wall
	Maximum storage density		4 gal/ft ² in storage or display areas and adjacent aisles
NFPA 30, Section 6.8	Maximum quantity allowed ³	120 gal	30,000 gal per occupancy

Notes:

(1) For SI units, 1 gal = 3.8 L; 1 ft² = 0.09 m².

(2) Existing unprotected mercantile occupancies in operation prior to January 1, 1997, are permitted to store up to 7500 gal (28,350 L) of Class IB, IC, II, and IIIA liquids (any combination) in each area.

¹Ground level floor only.

²For storage heights that do not exceed 3.6 m (12 ft).

³Does not include liquids exempted by 6.1.1.

6.5.6.3 On floors above the ground level, the storage or display of Class I and Class II liquids shall be limited to 230 L (60 gal) in unprotected occupancies and 454 L (120 gal) in protected occupancies.

6.5.6.4 Class I and Class II liquids shall not be permitted to be stored or displayed in basements.

6.5.6.5 Liquids in containers of greater than 20 L (5.3 gal) capacity shall not be stored or displayed in areas that are accessible to the public.

Exception: This shall not apply to any liquid that is exempt from the requirements of this chapter, as set forth in 6.1.2.

6.5.6.6 Class II liquids that are not water-miscible and are packaged in plastic containers of 3.8 L (1 gal) capacity or greater shall be limited to a maximum total quantity of 114 L (30 gal) per pile. Adjacent piles shall be separated by a minimum distance of 15 m (50 ft). This maximum total quantity shall be permitted to be doubled to 230 L (60 gal), if the liquids are stored in listed flammable liquids storage cabinets or are in areas protected by an automatic sprinkler system having a design density of 0.60 gpm per ft² over 24.4 mm/min over 230 m² (2500 ft²) and using high temperature, extra-large orifice quick-response sprinklers.

6.5.6.7 Protection systems for storage and display of liquids that are designed and developed based on full-scale fire tests performed at an approved test facility shall be considered an acceptable alternative to the protection criteria set forth in Section 6.8. Such alternative protection systems shall be approved by the authority having jurisdiction.

6.5.6.8 Means of egress from mercantile occupancies shall meet applicable requirements of NFPA 101, *Life Safety Code*.

6.5.6.9 Power-operated industrial trucks used to move Class I liquids shall be selected, operated, and maintained in accordance with NFPA 505, *Fire Safety Standard for Powered Industrial Trucks Including Type Designations, Areas of Use, Conversions, Maintenance, and Operation*.

6.6* Hazardous Materials Storage Lockers.

6.6.1 Hazardous materials storage lockers that are used as inside rooms shall be considered inside liquid storage rooms and shall meet the requirements for inside rooms as set forth in Section 6.4, as applicable.

6.6.2 Subsections 6.6.3 and 6.6.4 shall apply to storage of flammable and combustible liquids in containers, in hazardous materials storage lockers (hereinafter referred to as lockers) that are located outside.

6.6.3 The design and construction of a locker shall meet all applicable local, state, and federal regulations and requirements and shall be subject to the approval of the authority having jurisdiction. Movable prefabricated structures that have been examined, listed, or labeled by an organization acceptable to the authority having jurisdiction for use as a hazardous materials storage facility shall be acceptable.

6.6.3.1 Lockers governed by Section 6.6 shall not exceed 140 m² (1500 ft²) gross floor area. Vertical stacking of lockers shall not be permitted.

6.6.3.2 Where electrical wiring and equipment is required, it shall comply with 6.4.2.6.

6.6.3.3 Where dispensing or filling is permitted inside a locker, operations shall comply with the provisions of Chapter 7.

6.6.3.4 Ventilation shall be provided in accordance with 6.4.2.7.

6.6.3.5 Lockers shall include a spill containment system to prevent the flow of liquids from

the structure under emergency conditions. The containment system shall have sufficient capacity to contain 10 percent of the volume of containers allowed or the volume of the largest container, whichever is greater.

6.6.4 Designated sites shall be provided for the location and use of lockers and shall be subject to the approval of the authority having jurisdiction. The designated sites shall be arranged to provide at least the minimum separation distance between individual lockers, distance from locker to property line that is or can be built upon, and distance from locker to nearest side of public ways or to important buildings on the same property, as given in Table 6.6.4 and explanatory notes 1, 2, 3, and 4, as applicable.

Table 6.6.4 Designated Sites

Area of Designated Site ¹ (ft ²)	Minimum Separation Distance (ft)		
	Between Individual Lockers	From Locker to Property Line that Is or Can Be Built Upon ²	From Locker to Nearest Side of Public Ways or to Important Buildings on Same Property
≤ 100	5	10	5
>100 and ≤ 500	5	20	10
>500 and ≤ 1500 ⁴	5	30	20

Notes:

(1) For SI units, 1 ft = 0.3 m; 1 ft² = 0.09 m².

(2) If the locker is provided with a fire resistance rating of not less than 4 hours and deflagration venting is not required in accordance with 6.4.2.4, all distances required by Table 6.6.4 shall be permitted to be waived.

¹Site area limits are intended to differentiate the relative size and thus the number of lockers that are permitted on one designated site.

²Distances apply to properties that have protection for exposures, as defined. If there are exposures and such protection for exposures does not exist, the distances shall be doubled.

³When the exposed building has an exterior wall, facing the designated site, that has a fire resistance rating of at least 2 hours and has no openings to abovegrade areas within 3 m (10 ft) horizontally and no openings to belowgrade areas within 15 m (50 ft) horizontally of the designated area, the distances can be reduced to half of those shown in the table, except they shall never be less than 1.5 m (5 ft).

⁴When a single locker has a gross single story floor area that will require a site area limit of greater than 140 m² (1500 ft²) or when multiple units exceed the area limit of 140 m² (1500 ft²), the authority having jurisdiction shall be consulted for approval of distances.

6.6.4.1 Once the designated site is approved, it shall not be changed without the approval of the authority having jurisdiction.

6.6.4.2 More than one locker shall be permitted on a designated site, provided that the separation distance between individual lockers is maintained in accordance with Table 6.6.4.

6.6.4.3 Where the approved designated storage site is accessible to the general public, it shall be protected from tampering or trespassing.

6.6.4.4 Storage Practices.

6.6.4.4.1 Containers of liquid in their original shipping packages shall be permitted to be

stored either palletized or solid piled. Unpackaged containers shall be permitted to be stored on shelves or directly on the floor of the locker. Containers over 114 L (30 gal) capacity storing Class I or Class II liquids shall not be stored in arrangements more than two containers high. In all cases, the storage arrangement shall provide unrestricted access to and egress from the locker.

6.6.4.4.2 No other flammable or combustible materials storage shall be permitted within the designated site approved for lockers.

6.6.4.4.3 Placarding or warning signs for lockers shall be in accordance with applicable local, state, and federal regulations or with NFPA 704, *Standard System for the Identification of the Hazards of Materials for Emergency Response*.

6.7 Outdoor Storage.

6.7.1 Outdoor storage of liquids in containers, intermediate bulk containers, and portable tanks shall be in accordance with Table 6.7.1, 6.7.1.1 through 6.7.1.4, and 6.7.2 through 6.7.4.

Table 6.7.1 Outdoor Liquid Storage in Containers and

Class	Maximum Capacity and Height of a Pile					
	Containers		Rigid Plastic and Composite IBCs		Portable Tanks and Me	
	Capacity (gal) ^{b,c,d}	Height (ft)	Capacity (gal)	Height (ft)	Capacity (gal) ^{b,d}	F
IA	1,100	10	—	—	2,200	
IB	2,200	12	—	—	4,400	
IC	4,400	12	—	—	8,800	
II	8,800	12	8,800	12	17,600	
III	22,000	18	22,000	18	44,000	

Note: For SI units, 1 ft = 0.3 m; 1 gal = 3.8 L.

^aStorage of Class I liquids in rigid plastic and composite IBCs not permitted.

^bSee 6.7.1.1 regarding mixed-class storage.

^cSee 6.7.1.4 for smaller pile sizes.

^dFor storage in racks, the quantity limits per pile do not apply, but the rack arrangements shall be limited to a (ft) in depth.

^eSee 6.7.1.3 regarding protection for exposures.

6.7.1.1 Where two or more classes of materials are stored in a single pile, the maximum gallonage in that pile shall be the smallest of the two or more separate gallonages.

6.7.1.2 No container, intermediate bulk container, or portable tank in a pile shall be more than 60 m (200 ft) from a minimum 6 m (20 ft) wide accessway to permit approach of fire control apparatus under all weather conditions.

6.7.1.3 The distances listed in Table 6.7.1 shall apply to properties that have protection for exposures as defined. If there are exposures, and such protection for exposures does not exist, the distance to property line that is or can be built upon shall be doubled.

6.7.1.4 Where total quantity stored does not exceed 50 percent of the maximum per pile given in Table 6.7.1, the distances to a property line that is or can be built upon and to streets, alleys, or public ways shall be permitted to be reduced by 50 percent but not to less than 0.9 m (3 ft).

6.7.2 A maximum of 4160 L (1100 gal) of liquids in closed containers, intermediate bulk containers, and portable tanks shall be permitted to be stored adjacent to a building under the same management provided the following conditions apply:

- (1) The adjacent building wall has an exterior fire resistance rating of 2 hours.
- (2) There are no openings to areas at grade or above grade that are within 3 m (10 ft) horizontally of the storage.
- (3) There are no openings directly above the storage.
- (4) There are no openings to areas below grade within 15 m (50 ft) horizontally of the storage.

Exception: The provisions in 6.7.2(1) through 6.7.2(4) are not necessary if the building in question is limited to one story, is of fire-resistive or noncombustible construction, is devoted principally to the storage of liquids, and is acceptable to the authority having jurisdiction.

6.7.2.1 The quantity of liquids stored adjacent to a building protected in accordance with 6.7.2 shall be permitted to exceed that permitted in 6.7.2, provided the maximum quantity per pile does not exceed 4160 L (1100 gal) and each pile is separated by a 3 m (10 ft) minimum clear space along the common wall.

6.7.2.2 Where the quantity stored exceeds the 4160 L (1100 gal) permitted adjacent to the building given in 6.7.2, or the provisions of 6.7.2 cannot otherwise be met, a minimum distance equal to that shown in Table 6.7.1 for distance to property line shall be maintained between buildings and the nearest container or portable tank.

6.7.3 The storage area shall be graded in a manner to divert possible spills away from buildings or other exposures or shall be surrounded by a curb at least 150 mm (6 in.) high. Where curbs are used, provisions shall be made for draining of accumulations of groundwater or rainwater or spills of liquids. Drains shall terminate at a safe location and shall be accessible to operation under fire conditions.

6.7.4 The storage area shall be protected against tampering or trespassers where necessary and shall be kept free of weeds, debris, and other combustible materials not necessary to the storage.

6.7.5 Outdoor storage of containers that are protected from the weather by a canopy or roof that does not limit the dissipation of heat or dispersion of flammable vapors and does not restrict fire-fighting access and control shall be treated as outside storage in accordance with Section 6.7 and shall not be considered an inside storage area subject to the requirements of Section 6.4.

6.8* Automatic Fire Protection for Inside Storage.

Copyright NFPA

6.8.1 Scope. Section 6.8 shall apply to all storage of liquids in containers and portable tanks as specified in Section 6.2 through Section 6.5.

6.8.1.1 Where different classes of liquids and container types are stored in the same protected area, protection shall meet the requirements of Section 6.8 for the most severe hazard class present.

6.8.1.2 Where storage is on racks as permitted by this code, racks storing Class I, Class II, or Class IIIA liquids shall be either single row or double row, as described in NFPA 230, *Standard for the Fire Protection of Storage*. Unless otherwise specified by Section 6.8, single-row racks shall be not more than 1.4 m (4.5 ft) wide and double-row racks shall be not more than 2.8 m (9 ft) wide.

6.8.1.3* For the purpose of Section 6.8, a relieving-style container shall mean a metal container, a metal intermediate bulk container, or a metal portable tank that is equipped with at least one pressure-relieving mechanism at its top that is designed, sized, and arranged to relieve the internal pressure generated due to exposure to fire so that violent rupture is prevented.

6.8.1.3.1 The pressure-relieving mechanism for containers shall be listed and labeled in accordance with Factory Mutual Research Corporation Class 6083, *Examination Program for Fusible Closures for Steel Drums*, or equivalent. The pressure-relieving mechanism shall not be painted. Cap seals, if used, shall be made of thermoplastic material.

6.8.1.3.2 For metal containers greater than 23 L (6 gal) capacity, the pressure-relieving mechanism shall be unobstructed or an additional pressure-relieving mechanism shall be provided.

6.8.1.4 For new fire protection systems installed after January 1, 1997, fire protection systems shall meet the requirements of Section 6.8.

6.8.1.5 When applying the fire protection criteria of Section 6.8, a minimum aisle space of 1.8 m (6 ft) shall be provided between adjacent piles or adjacent rack stations, unless otherwise specified in the tables in 6.8.2.

6.8.1.6* For the purposes of Section 6.8, any liquid that gels, thickens, or solidifies when heated; or whose viscosity at room temperature versus weight percent content of Class I, Class II, or Class III liquids is in the shaded portion of Figure 6.8.1.6 shall be permitted to be protected using either the criteria for a Class IIIB liquid in accordance with Figure 6.8.2(a) or Figure 6.8.2(b) or the criteria for Group A plastics in accordance with Figure 6.8.2(b), whichever is applicable.

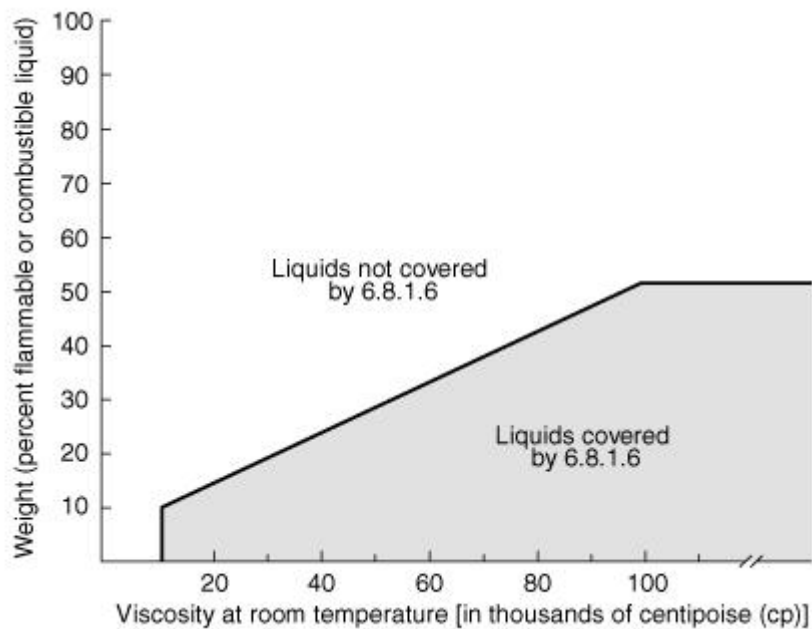

FIGURE 6.8.1.6 Viscosity Versus Weight Percent Flammable or Combustible Component.

6.8.1.7* For the purposes of Section 6.8, an unsaturated polyester resin (UPR) shall mean any such resin that contains up to 50 percent by weight of Class IC, Class II, or Class IIIA liquid, but no Class IA or Class IB liquid.

6.8.2* Automatic Sprinkler and Foam-Water Fire Protection Systems. Where automatic sprinklers or low-expansion foam-water sprinkler systems are used, the protection criteria of Table 6.8.2(a) through Table 6.8.2(k) shall be followed for the applicable liquid class, container type, and storage arrangement. Figure 6.8.2(a), Figure 6.8.2(b), and Figure 6.8.2(c) shall be used to specify protection criteria for liquid classes, container types, and storage arrangements not specifically covered in Table 6.8.2(a) through Table 6.8.2(k). All automatic sprinkler and foam-water fire protection systems shall be wet pipe, deluge, or preaction systems. If preaction systems are used, they shall be designed so that water or foam solution will immediately discharge from the sprinkler upon sprinkler actuation. Foam-water sprinkler systems that meet the design criteria specified in the water sprinkler tables in this section shall be acceptable.

Exception No. 1: Except as otherwise permitted in Section 6.2 through Section 6.7.

Exception No. 2: Table 6.8.2(a) through Table 6.8.2(j) shall not apply to unstable liquids.

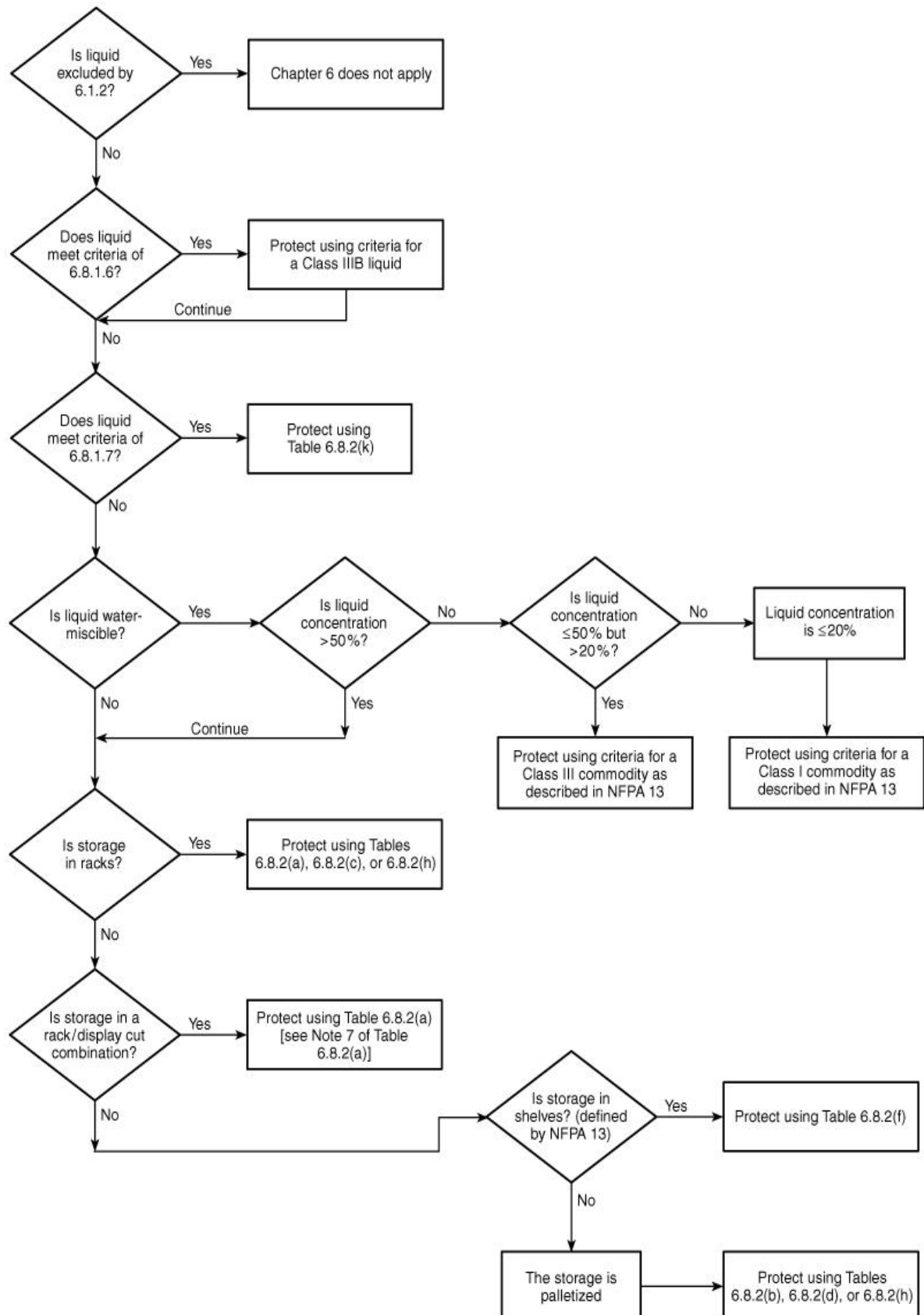

FIGURE 6.8.2(a) Fire Protection Criteria Decision Tree for Flammable and Combustible Liquids in Metal Containers.

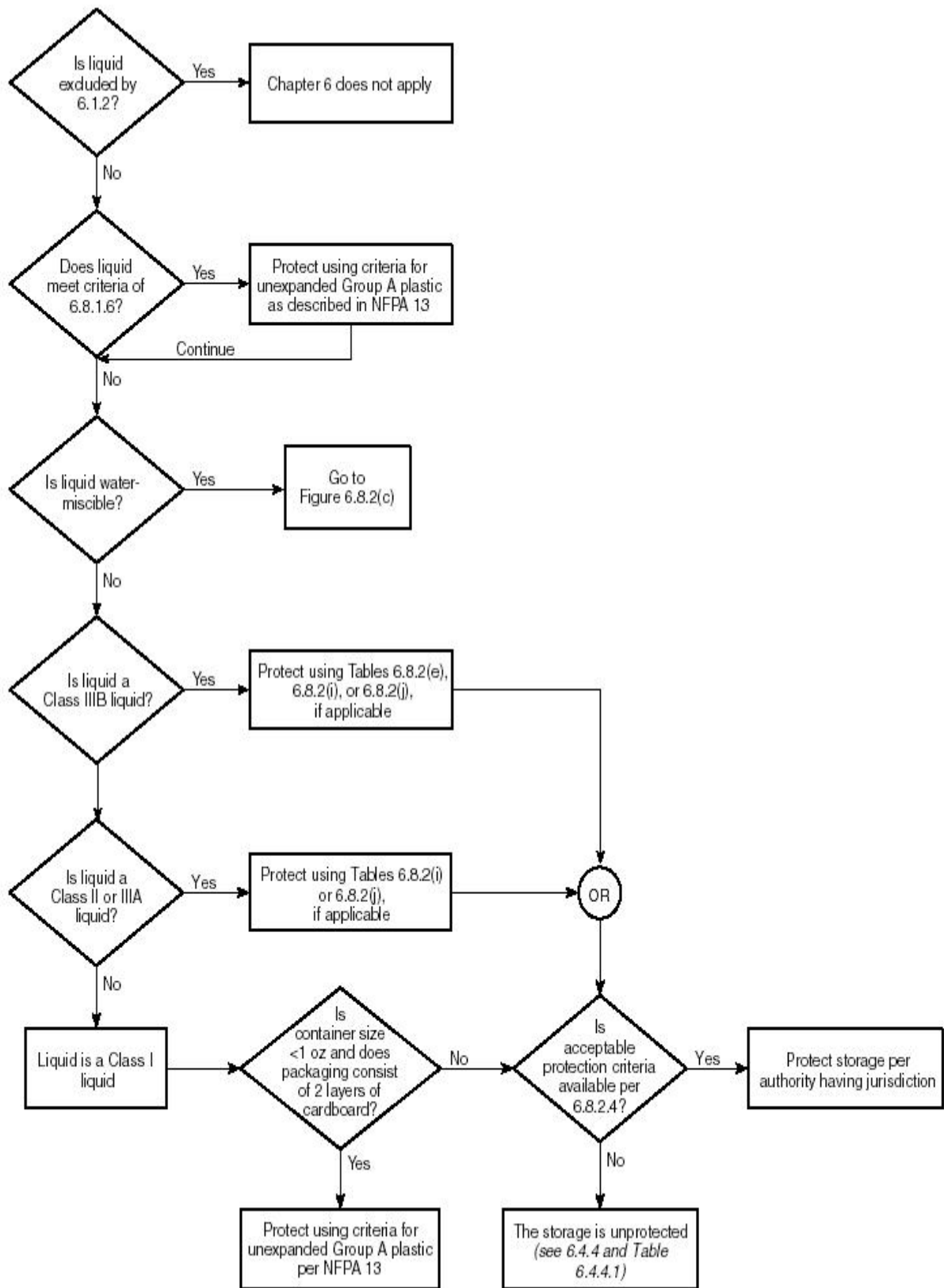
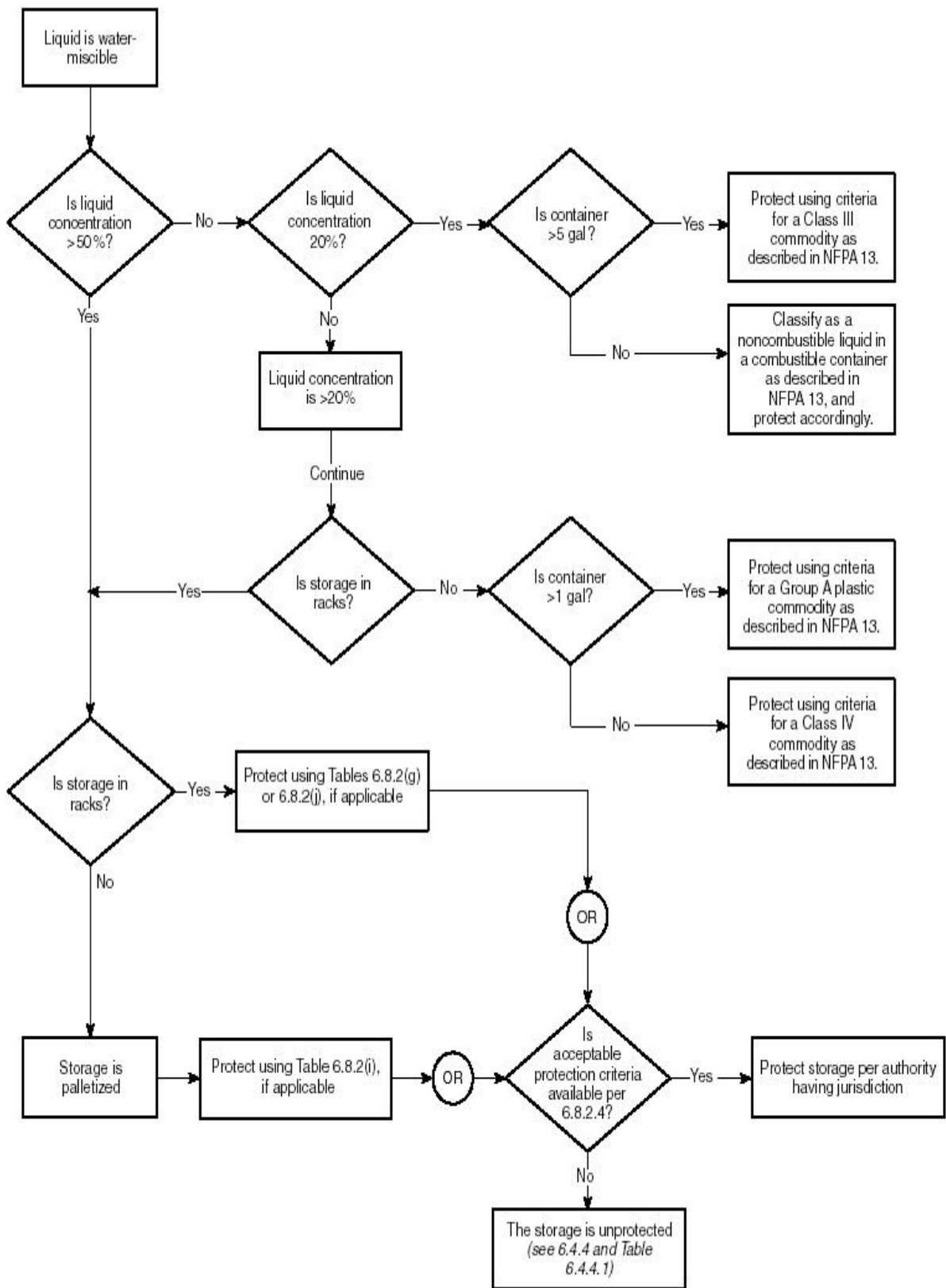

FIGURE 6.8.2(b) Fire Protection Criteria Decision Tree for Flammable and Combustible Liquids in Glass, Plastic, or Fiberboard Containers.



Note: For SI units, 1 gal = 3.8 L.

FIGURE 6.8.2(c) Fire Protection Criteria Decision Tree for Water-Miscible Flammable and Combustible Liquids in Glass, Plastic, or Fiberboard Containers.

Table 6.8.2(a) Water Sprinkler Protection for Single- or Double-Row Rack Storage Intermediate Bulk Containers (for Nonmiscible Liquids or Miscible Liquids with Flam

Liquid Class	Container Size (gal)	Maximum Storage Height (ft)	Maximum Ceiling Height (ft)	Ceiling		
				Sprinkler Type		Density (gpm/ft ²)
				Nominal K-Factor ^a	Response ^a	
Nonrelieving-Style Container						
IB, IC, II, or III	≤ 1	16	30	≥ 11.2	QR	0.60
	≤ 1	20	30	≥ 11.2	SR or QR	0.60
IB, IC, II, or IIIA IIIB	≤ 5	25	30	≥ 8.0	SR or QR	0.30
	≤ 5	40	50	≥ 8.0	SR or QR	0.30
IB, IC, II, or IIIA IIIB	>5 and ≤ 60	25	30	≥ 11.2	SR	0.40
	>5 and ≤ 60	40	50	≥ 8.0	SR	0.30
Relieving-Style Containers^d						
IB, IC, II, or IIIA	≤ 5	14	18	≥ 11.2	QR	0.65
	≤ 5	25	30	≥ 8.0	SR or QR	0.30
IIIB	≤ 5	40	50	≥ 8.0	SR or QR	0.30
IB, IC, II, or IIIA	>5 and ≤ 60	25	30	≥ 11.2	SR	0.60

Table 6.8.2(a) Water Sprinkler Protection for Single- or Double-Row Rack Storage Intermediate Bulk Containers (for Nonmiscible Liquids or Miscible Liquids with Flam

Liquid Class	Container Size (gal)	Maximum Storage Height (ft)	Maximum Ceiling Height (ft)	Ceiling		
				Sprinkler Type		Density (gpm/ft ²)
				Nominal K-Factor ^a	Response ^a	
IIIB	>5 and ≤60	40	50	≥8.0	SR	0.30
IB, IC, II, or IIIA	Portable tanks, IBCs	25	30	≥11.2	SR	0.60
IIIB	Portable tanks, IBCs	40	50	≥8.0	SR	0.30

Notes:

(1) For SI units, 1 gal = 3.8 L; 1 ft = 0.3 m; 1 ft² = 0.09 m²; 1 gpm/ft² = 40.7 L/min/m² = 40.7 mm/min.

(2) Double-row racks 1.8 m (6 ft) wide maximum.

(3) Space in-rack sprinklers on maximum 3 m (10 ft) centers, staggered vertically. Base design on 30 gpm per operating in each of upper three levels, or eight hydraulically most remote sprinklers if only one level. In-rack with shields.

(4) Use pendent-style K-11.2 ceiling sprinklers.

(5) Space in-rack sprinklers on maximum 9 ft centers staggered vertically, 115 L/min (30 gpm per sprinkler) if six hydraulically most remote sprinklers each level (upper three levels) operating. Eight sprinklers operating, if

(6) Protection for uncartoned or case-cut nonsolid shelf display up to 2 m (6½ ft) and storage above in pallets (2 mm (2 in. × 6 in.) wooden slats, spaced a minimum of 50 mm apart.

(7) A 0.60 density shall be used if more than one level of storage exists above the top level of in-rack sprinkler

(8) A 24.4 mm/min over 186 m² (0.60 density/2000 ft²) shall be used if more than one level of storage exists above ceiling sprinklers).

^aSR = standard response and QR = quick response, where both are listed.

^bHigh temperature ceiling sprinklers.

^cSee Table D.2(a) for references to fire tests on which the protection criteria given in this table are based.

^dBoth 20 mm (¾ in.) and 50 mm (2 in.) listed and labeled pressure-relieving mechanisms are required on containers.

Table 6.8.2(b) Water Sprinkler Protection for Bulk or Palletized Storage of Metal Containers (for Nonmiscible Liquids or Miscible Liquids with Flammable Liquids)

Liquid Class	Container Size (gal)	Maximum Storage Height (ft)	Maximum Ceiling Height (ft)	Ceiling		
				Sprinkler Type		Density (gpm/ft ²)
				Nominal K-factor	Response ^a	
IB, IC, II, or IIIA	≤5	4	18	≥8.0	SR or QR	0.21

Table 6.8.2(b) Water Sprinkler Protection for Bulk or Palletized Storage of Metal Containers (for Nonmiscible Liquids or Miscible Liquids with Flammable Liquids)

Liquid Class	Container Size (gal)	Maximum Storage Height (ft)	Maximum Ceiling Height (ft)	Ceiling		
				Sprinkler Type		Density (gpm/ft ²)
				Nominal K-factor	Response ^a	
IIIB	≤ 5	5	18	≥ 8.0	SR or QR	0.30
	≤ 5	6½	30	≥ 11.2	QR	0.45
	>5 and ≤ 60	5	18	≥ 11.2	SR	0.40
	≤ 5	18	30	≥ 8.0	SR or QR	0.25
	>5 and ≤ 60	10	20	≥ 8.0	SR	0.25
			18	30	≥ 8.0	SR
Relieving-Style Containers^d						
IB, IC, II, or IIIA	≤ 5	12	30	≥ 11.2	QR	0.60
	>5 and ≤ 60	5	30	≥ 11.2	SR	0.40
	>5 and ≤ 60	6½	30	≥ 11.2	SR	0.60
IIIB	≤ 5	18	30	≥ 8.0	SR or QR	0.25
	>5 and ≤ 60	10	20	≥ 8.0	SR	0.25
			18	30	≥ 8.0	SR
IB, IC, II, or IIIA	Portable tanks, IBCs	1 high	30	≥ 8.0	SR	0.30
		2 high	30	≥ 11.2	SR	0.60
IIIB	Portable tanks, IBCs	1 high	30	≥ 8.0	SR	0.25
		2 high	30	≥ 11.2	SR	0.50

Notes:

(1) For SI units, 1 gal = 3.8 L; 1 ft = 0.3 m; 1 ft² = 0.09 m²; 1 gpm/ft² = 40.7 L/min/m² = 40.7 mm/min.

(2) Minimum hose stream demand: 250 gpm for 2 hours.

(3) Sprinklers shall also be hydraulically calculated to provide a density of 32.6 mm/min over 93 m² (0.80 gpm).

(4) Use pendant-style K-11.2 ceiling sprinklers.

(5) Drums placed on open slatted pallet, not nested, to allow pressure relief from drums on lower levels.

^aSR = standard response and QR = quick response, where both are listed.

^bHigh-temperature ceiling sprinklers.

^cSee Table D.2(b) for references to fire tests on which the protection criteria given in this table are based.

^dBoth 20 mm (¾ in.) and 50 mm (2 in.) listed and labeled pressure-relieving mechanisms are required on containers.

Table 6.8.2(c) Foam-Water Sprinkler Protection for Single- or Double-Row Rack Storage Containers, and Portable Tanks (for Nonmiscible Liquids or Miscible Liquids with Flammable Liquids)

Liquid Class	Container Size (gal)	Maximum Storage Height (ft)	Maximum Ceiling Height (ft)	Sprinkler Type		Density (gpm/ft ²)
				Nominal K-factor	Response ^a	

Table 6.8.2(c) Foam-Water Sprinkler Protection for Single- or Double-Row Rack Storage Containers, and Portable Tanks (for Nonmiscible Liquids or Miscible Liquids with Flammable Liquids)

Liquid Class	Container Size (gal)	Maximum Storage Height (ft)	Maximum Ceiling Height (ft)	Ceiling		Density (gpm/ft ²)
				Sprinkler Type		
				Nominal K-Factor	Response ^a	
Nonrelieving-Style Container						
IB, IC, II, or IIIA	≤ 5	25	30	≥ 8.0	SR or QR	0.3
	>5 and ≤ 60	25	30	≥ 8.0	SR	0.3
IIIB	≤ 60	40	50	≥ 8.0	SR	0.3
Relieving-Style Containers^d						
IB, IC, II, IIIA	≤ 5	25	30	≥ 8.0	SR or QR	0.3
	>5 and ≤ 60, portable tanks, IBCs	25	30	≥ 8.0	SR	0.3
IIIB	≤ 60	40	50	≥ 8.0	SR	0.3

Notes:

(1) For SI units, 1 gal = 3.8 L; 1 ft = 0.3 m; 1 ft² = 0.09 m²; 1 gpm/ft² = 40.7 L/min/m² = 40.7 mm/min.

(2) Space in-rack sprinklers on maximum 10 ft centers, staggered vertically. Base design in 30 gpm per sprinkler each of upper three levels. Sprinklers are K-5.6 or K-8.0, SR or QR, ordinary temperature, with shields. Hydraulic level — three levels operating simultaneously when using a pre-primed foam-water system installed in accordance with *Foam-Water Sprinkler and Foam-Water Spray Systems*, and maintained according to NFPA 25, *Standard for the Inspection, Testing, and Maintenance of Water-Based Fire Protection Systems*.

(3) Design area can be reduced to 140 m² (1500 ft²) when using a pre-primed foam-water system installed in accordance with NFPA 25.

(4) Design area can be reduced to 186 m² (2000 ft²) when using a pre-primed foam-water system installed in accordance with NFPA 25.

^aSR = standard response and QR = quick response, where both are listed.

^bHigh-temperature ceiling sprinklers.

^cSee Table D.2(c) for references to fire tests on which the protection criteria given in this table are based.

^dBoth 20 mm (¾ in.) and 50 mm (2 in.) listed and labeled pressure-relieving mechanisms are required on containers.

Table 6.8.2(d) Foam-Water Sprinkler Protection for Bulk or Palletized Storage of Metal Containers and Portable Tanks (for Nonmiscible Liquids or Miscible Liquids with Flammable Liquids)

Liquid Class	Container Size (gal)	Maximum Storage Height (ft)	Maximum Ceiling Height (ft)	Sprinkler Type		Dens (gpm/ft ²)
				Nominal K-Factor	Response ^a	

Table 6.8.2(d) Foam-Water Sprinkler Protection for Bulk or Palletized Storage of Metal Portable Tanks (for Nonmiscible Liquids or Miscible Liquids with Flammable I

Liquid Class	Container Size and Arrangement (gal)	Maximum Storage Height (ft)	Maximum Ceiling Height (ft)	Ceiling	
				Sprinkler Type	
				Nominal K-Factor	Response ^a
Nonrelieving-Style Container					
IB, IC, II, or IIIA	≤ 5 cartoned	11	30	≥ 11.2	SR or QR
	≤ 5 uncartoned	12	30	≥ 8.0	SR or QR
	>5 and ≤ 60	5 ^d	30	≥ 8.0	SR
Relieving-Style Containers^g					
IB, IC, II, or IIIA	>5 and ≤ 60	6½	30	≥ 8.0	SR
	>5 and ≤ 60	10 ^e	33	≥ 11.2	SR
	>5 and ≤ 60	13 ft 9 in. ^f	33	≥ 11.2	SR
	Portable tanks, IBCs	2-high maximum	30	≥ 8.0	SR

Notes:

(1) For SI units, 1 gal = 3.8 L; 1 ft = 0.3 m; 1 ft² = 0.09 m²; 1 gpm/ft² = 40.7 L/min/m² = 40.7 mm/min.

(2) Drums placed on open slatted pallet, not nested, to allow pressure relief from drums on lower levels.

(3) Design area can be reduced to 186 m² (2000 ft²) when using a pre-primed foam-water system installed in a *Foam-Water Sprinkler and Foam-Water Spray Systems*, and maintained according to NFPA 25, *Standard for Fire Protection Systems*.

(4) Both 20 mm (¾ in.) and 50 mm (2 in.) listed pressure-relieving mechanisms are required on containers greater than 60 gal.

^aSR = standard response and QR = quick response, where both are listed.

^bHigh-temperature ceiling sprinklers.

^cSee Table D.2(d) for references to fire tests on which the protection criteria given in this table are based.

^d1 high.

^e3 high.

^f4 high.

Table 6.8.2(e) Water Sprinkler Protection for Single-, Double-, and Multi-Row Open End Containers (for Nonmiscible Flammable and Combustible Liquids or Miscible Flammable Liquids >50% of volume)

Liquid Type or Closed-Cup Flash Point (°F)	Container Size (gal)	Maximum Building or Ceiling Height	Packaging Type	Maximum Storage Height	Minimum Aisle Width (ft)	R:
--	----------------------	------------------------------------	----------------	------------------------	--------------------------	----

Table 6.8.2(e) Water Sprinkler Protection for Single-, Double-, and Multi-Row Open Frame Containers (for Nonmiscible Flammable and Combustible Liquids or Miscible Flammable Liquids >50% of volume)

Liquid Type or Closed-Cup Flash Point (°F)	Container Size (gal)	Maximum Building or Ceiling Height (ft)	Packaging Type	Maximum Storage Height (ft)	Minimum Aisle Width (ft)	R ₁
≥ 200	≤ 5	Unlimited	Cartoned or uncartoned	Unlimited	4	

Note: For SI units, 1 gal = 3.8 L; 1 ft = 0.3 m.

†See Table D.2(e) for reference to the fire test on which the protection criteria given in this table are based.

Table 6.8.2(f) Water Sprinkler Protection for Shelf Storage of Metal Containers (for Nonrelieving-Style Containers) (for Nonmiscible Flammable and Combustible Liquids or Miscible Flammable Liquids >50% by volume)

Liquid Class	Container Size (gal)	Maximum Storage Height (ft)	Maximum Ceiling Height (ft)	Ceiling	
				Sprinkler Type	
				Nominal K-Factor	Response ^a
IB, IC, II, or III	≤ 1	6	18	≥ 8.0	SR or QR

Notes:

(1) For SI units, 1 gal = 3.8 L; 1 ft = 0.3 m; 1 ft² = 0.09 m²; 1 gpm/ft² = 40.7 L/min/m² = 40.7 mm/min.

(2) Protection for mercantile shelving that is 600 mm (2 ft) or less in depth per side, with backing between each side.

(3) Minimum hose stream demand 950 L/min (250 gpm) for 2 hours.

^aSR = standard response and QR = quick response, where both are listed.

^bHigh-temperature ceiling sprinklers.

^cSee Table D.2(f) for references to fire tests on which the protection criteria given in this table are based.

Table 6.8.2(g) Water Sprinkler Protection for Single- and Double-Row Open Frame Plastic Containers (Flammable Liquid Concentration >50% of volume)

Liquid Class	Container Size (gal)	Maximum Building or Ceiling Height (ft)	Packaging Type	Maximum Storage Height (ft)	Minimum Aisle Width (ft)	R ₁
IB, IC, II, III	≤ 1	Unlimited	Cartoned	Unlimited	8	
	≤ 60	30	Uncartoned or cartoned	25	8	
	≤ 16 oz	Unlimited	Cartoned	Unlimited	8	

Table 6.8.2(g) Water Sprinkler Protection for Single- and Double-Row Open Frame Plastic Containers (Flammable Liquid Concentration >50%)

Liquid Class	Container Size (gal)	Maximum Building or Ceiling Height (ft)	Packaging Type	Maximum Storage Height (ft)	Minimum Aisle Width (ft)	Rack
--------------	----------------------	---	----------------	-----------------------------	--------------------------	------

Note: For SI units, 1 gal = 3.8 L; 1 ft = 0.3 m.

^aSee Table D.2(g) for reference to the fire test on which the protection criteria given in this table are based.

Table 6.8.2(h) Water Sprinkler Protection for Rack and Palletized Storage of Class IB, Metal Containers with Aisles a Minimum of 7.5 ft Wide (for Nonmiscible Flammable or Combustible Liquids with Concentrations >50%)

Storage Arrangement	Rack Width (ft)	Shelf Type	Building Height (ft)	Max. Storage Height (ft)	Container Size (gal)	Packaging Type	Ceiling Sprinkler Protection Criteria		
							Sprinkler Type/ K-Factor/ Temp. Rating ^a	Design (No. of Sprinklers @ Pressure)	Installation
Rack with 7.5 ft aisle	≤ 6	Open wire mesh and/or none	24	14	≤ 5 <i>(see Note 3)</i>	Uncartoned or cartoned	Pendent ESFR, K-14.0, Ordinary	12 @ 50 psig	F 6.
							Pendent ESFR, K-25.0, Ordinary	12 @ 25 psig	1
Rack with 8 ft aisle	≤ 9	None	30	20	≤ 1	Cartoned only	Pendent ESFR, K-14.0, Ordinary	12 @ 75 psig	1
				25	≤ 1	Cartoned only	Pendent ESFR, K-14.0, Ordinary	12 @ 50 psig	F 6.
				25	≤ 5	Uncartoned or cartoned	Pendent ESFR, K-14.0, Ordinary	12 @ 75 psig	F 6.

Table 6.8.2(h) Water Sprinkler Protection for Rack and Palletized Storage of Class IB, Metal Containers with Aisles a Minimum of 7.5 ft Wide (for Nonmiscible Flammable or Combustible Liquids with Concentrations >50% b

Storage Arrangement	Rack Width (ft)	Shelf Type	Building Height (ft)	Max. Storage Height (ft)	Container Size (gal)	Packaging Type	Ceiling Sprinkler Protection Criteria		
							Sprinkler Type/ K-Factor/ Temp. Rating ^a	Design (No. of Sprinklers @ Pressure)	In-Rack
Palletized	DNA ^e	DNA	30	8	≤ 1	Cartoned only	Pendent ESFR, K-14.0, Ordinary	12 @ 50 psig	1
				12	≤ 5	Uncartoned or cartoned	Pendent ESFR, K-14.0, Ordinary	12 @ 75 psig	1

Notes:

(1) For SI units, 1 gal = 3.8 L; 1 in. = 25 mm; 1 ft = 0.3 m; 1 psig = 6.9 kPa.

(2) The in-rack sprinkler water demand shall be based on the simultaneous operation of the most hydraulically

(a) Seven sprinklers where only one level of in-rack sprinklers is installed.

(b) Fourteen sprinklers (seven on each two top levels) where more than one level of in-rack sprinklers is installed.

(c) The in-rack end sprinkler design pressure as provided in the table.

(3) The in-rack sprinkler water demand shall be balanced with the ceiling sprinkler water demand at their point of discharge.

(4) Five L (nom. 1 gal) and 1 L (1 qt) containers do not need to be relieving style.

(5) Provide minimum 3 in. transverse flue at rack uprights.

^aESFR = early suppression fast response.

^bFigure 6.8.6.3(a) through Figure 6.8.6.3(e) can be found in 6.8.6.3.

^cQR = quick response, ordinary temperature range.

^dSee Table D.2(h) for references to fire tests on which the protection criteria given in this table are based.

^eDNA = does not apply.

Table 6.8.2(i) Water Sprinkler Protection^a for Bulk or Palletized Storage of Containers of Nonmiscible Combustible Liquids or Miscible Combustible Liquids with Liquid Concentrations >50%

Liquid Class	Container Size ^c (gal)	Maximum Storage Height	Maximum Ceiling Height (ft)	Sprinkler Type	
				Nominal K-Factor	Response
II, III	≤ 793	1 high	30	≥ 11.2	High temperature
	≤ 793	2 high	30	≥ 11.2	High temperature

Table 6.8.2(i) Water Sprinkler Protection^a for Bulk or Palletized Storage of Contained Nonmiscible Combustible Liquids or Miscible Combustible Liquids with Liquid

Liquid Class	Container Size ^c (gal)	Maximum Storage Height	Maximum Ceiling Height (ft)	Sprinkler Type	
				Nominal K-Factor	Response

Note: For SI units, 1 gal = 3.8 L; 1 ft = 0.3 m; 1 ft² = 0.09 m²; 1 gpm /ft³ = 40.7 L/min/m² = 40.7 mm/min.
^aFoam-water sprinkler protection shall be permitted to be substituted for water sprinkler protection, provided that the foam-water sprinkler is listed and labeled in accordance with UL 2368, *Standard Containers for Flammable and Combustible Liquids*, or equivalent.
^bRigid nonmetallic IBC — A rigid nonmetallic IBC that is listed and labeled in accordance with UL 2368, *Standard Containers for Flammable and Combustible Liquids*, or equivalent.
^cSee Annex E.1.
^dSee Table D.2(i) for reference to fire test on which the protection criteria given in this table are based.
^eSR = Standard Response.
^fSprinkler-operating pressure shall be a minimum gauge pressure of 207 kPa (30 psig).

Table 6.8.2(j) Water Sprinkler Protection for Single- and Double-Row, Open-Frame Rack Bulk Containers^a (for Nonmiscible Class II and Class III Liquids and for Miscible Class III Concentration by volume)

Liquid Class	Container Capacity ^b (gal)	Maximum Building or Ceiling Height (ft)	Maximum Storage Height ^c (ft)	Minimum Aisle Width (ft)	Rack Width (ft)
II, III	≤ 793	30	25	8	9

Note: For SI units, 1 gal = 3.8 L; 1 ft = 0.3 m.
^aRigid nonmetallic IBC — A rigid nonmetallic IBC that is listed and labeled in accordance with UL 2368, *Standard Containers for Flammable and Combustible Liquids*, or equivalent.
^bSee Annex E.1.
^cTier height shall not exceed 1.8 m (6 ft). (See 6.8.6.2.)
^dSee Table D.2(j) for references to fire tests on which protection criteria are based.

Table 6.8.2(k) Water Sprinkler Protection for Bulk or Palletized Metal Containers of Up to 50% by Weight Class IC, Class II, or Class IIIA Liquid Contents

Container Size (gal)	Maximum Storage Height (ft)	Maximum Ceiling Height (ft)	Ceiling Sprinkler Type		Design Density (gpm)
			Nominal K-Factor	Response	
>5 and <60	10	33	11.2	Standard Response, 165°F or 286°F	0

Table 6.8.2(k) Water Sprinkler Protection for Bulk or Palletized Metal Containers of U up to 50% by Weight Class IC, Class II, or Class IIIA Liquid C

Container Size (gal)	Maximum Storage Height (ft)	Maximum Ceiling Height (ft)	Ceiling		De (gpi)
			Nominal K-Factor	Response	

Notes:

(1) For SI units, 1 gal = 3.8 L; 1 ft = 0.3 m; 1 gpm/ft² = 40.7 L/min/m² = 40.7 mm/min; 1 ft² = 0.09 m².

(2) Drums placed on open, slatted pallet, not nested, to allow pressure relief from drums on lower levels.

(3) Storage areas containing unsaturated polyester resin (UPR) shall not be located in the same spill containment unless protected as required for such other liquids.

^aBoth 20 mm (¾ in.) and 50 mm (2 in.) listed and labeled pressure-relieving devices are required on container

^bSee Table D.2(k) for references to fire tests on which the protection criteria given in this table are based.

6.8.2.1 When foam or foam-water fire protection systems are provided, discharge densities shall be determined based on the listing criteria of the foam discharge devices selected, the foam concentrate, the specific liquids to be protected, and the criteria in Table 6.8.2(c) and Table 6.8.2(d). Where the discharge densities given in Table 6.8.2(c) and Table 6.8.2(d) differ from those in the listing criteria for the discharge devices, the greater of the two shall be used.

6.8.2.2 In-rack sprinklers shall be installed in accordance with the provisions of NFPA 13, *Standard for the Installation of Sprinkler Systems*.

Exception: As modified as follows:

- (1) *Alternate lines of in-rack sprinklers shall be staggered vertically in the longitudinal flue space.*
- (2) *Sprinkler heads of multiple-level sprinkler systems shall be provided with water shields unless they are separated by horizontal barriers or are specifically listed for installation without water shields.*
- (3) *A vertical clear space of at least 150 mm (6 in.) shall be maintained between the sprinkler deflector and the top of the tier of storage.*
- (4) *Sprinkler discharge shall not be obstructed by horizontal rack structural members.*
- (5) *Longitudinal and transverse flue spaces of at least 150 mm (6 in.) shall be maintained between each rack load.*

6.8.2.3 Ceiling sprinklers shall be installed in accordance with NFPA 13, *Standard for the Installation of Sprinkler Systems*, and shall be permitted to have the following maximum head spacing:

- (1) Classes I, II, and IIIA liquids: 9.3 m² (100 ft²) per sprinkler head
- (2) Class IIIB liquids: 11.1 m² (120 ft²) per sprinkler head

6.8.2.3.1 If ordinary or intermediate temperature-rated K-25 extended-coverage sprinklers

are used, the maximum area per sprinkler shall be governed by the listing of the sprinkler, rather than by the limitations of 6.8.2.3.

6.8.2.4 Protection systems that are designed and developed based on full-scale fire tests performed at an approved test facility or on other engineered protection schemes shall be considered an acceptable alternative to the protection criteria set forth in Section 6.8. Such alternative protection systems shall be approved by the authority having jurisdiction.

6.8.2.5 Water-based fire protection systems shall be inspected, tested, and maintained in accordance with NFPA 25, *Standard for the Inspection, Testing, and Maintenance of Water-Based Fire Protection Systems*.

6.8.2.6 The ceiling heights given in Table 6.8.2(a) through Table 6.8.2(k) shall be permitted to be increased by a maximum of 10 percent if an equivalent percent increase in ceiling sprinkler design density is provided.

6.8.2.7 Low-expansion foam-water sprinkler systems shall be designed and installed in accordance with NFPA 16, *Standard for the Installation of Foam-Water Sprinkler and Foam-Water Spray Systems*. The system shall have at least 15 minutes of foam concentrate, based on the required design flow rate.

6.8.2.8* Foam-water sprinkler systems shall be designed to provide foam-water solution at the design concentration with as few as four sprinklers flowing.

6.8.3 Other Automatic Fire Protection Systems. Alternate fire protection systems, such as automatic water spray systems, automatic water mist systems, high-expansion foam systems, dry chemical extinguishing systems, alternate sprinkler system configurations, or combinations of systems shall be permitted if approved by the authority having jurisdiction. Such alternate systems shall be designed and installed in accordance with the appropriate NFPA standard and with manufacturer's recommendations for the system(s) selected.

6.8.4 Water Supply. Water supplies for automatic sprinklers, other water-based protection systems, hose streams, and hydrants shall be capable of supplying the anticipated water flow demand for a minimum of 2 hours.

6.8.5 Containment and Drainage. Containment and drainage shall be provided in accordance with Figure 6.8.5, when protection systems are installed in accordance with the provisions of Table 6.8.2(a) through Table 6.8.2(k).

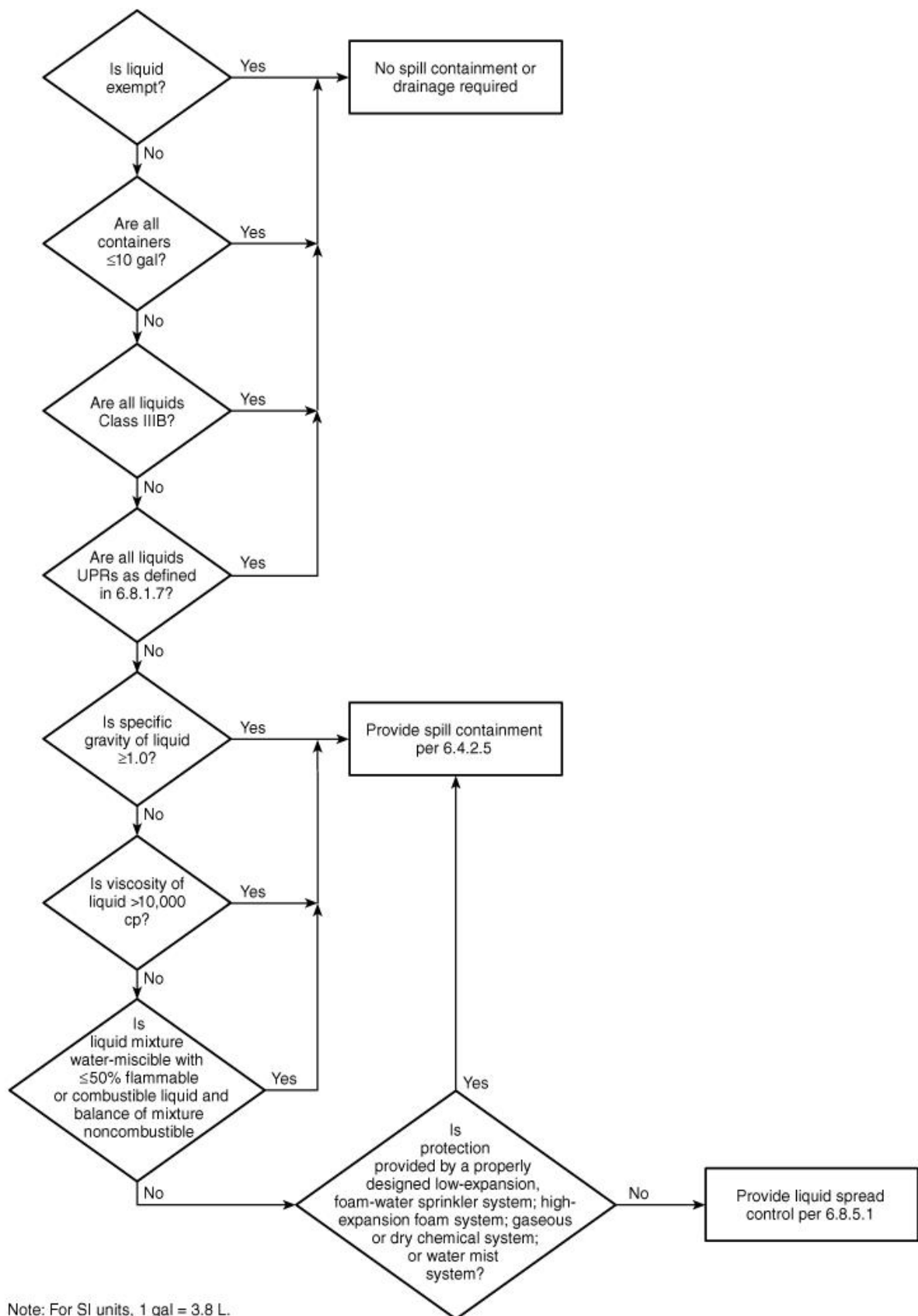

Note: For SI units, 1 gal = 3.8 L.

FIGURE 6.8.5 Spill Containment and Liquid Spread Control for Protected Storage.

6.8.5.1* Where control of liquid spread is required, means to limit the spread of liquid to an area not greater than the design discharge area of the ceiling sprinkler system shall be provided.

6.8.6 Fire Protection Schemes.

6.8.6.1 Fire Protection Scheme A.

6.8.6.1.1 Plywood of minimum 10 mm ($\frac{3}{8}$ in.) or sheet metal of minimum 22 gauge barriers and in-rack sprinklers shall be installed in accordance with Figure 6.8.6.1.1(a) and Figure 6.8.6.1.1(b). Figure 6.8.6.1.1(c) shall be used for storage of Class IIIB liquids. Vertical baffles shall not be provided between in-rack sprinklers.

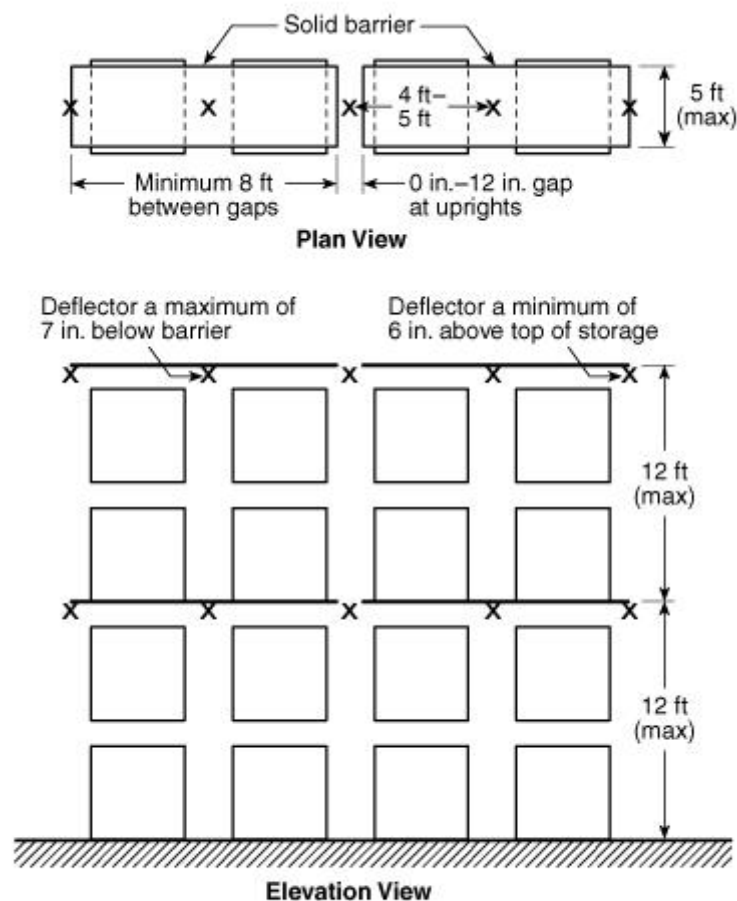

Notes: (1) For SI units, 1 in. = 25 mm; 1 ft = 0.3 m.
(2) X denotes K-8.0, ordinary, QR in-rack sprinkler.

FIGURE 6.8.6.1.1(a) Single-Row Rack Sprinkler Layout.

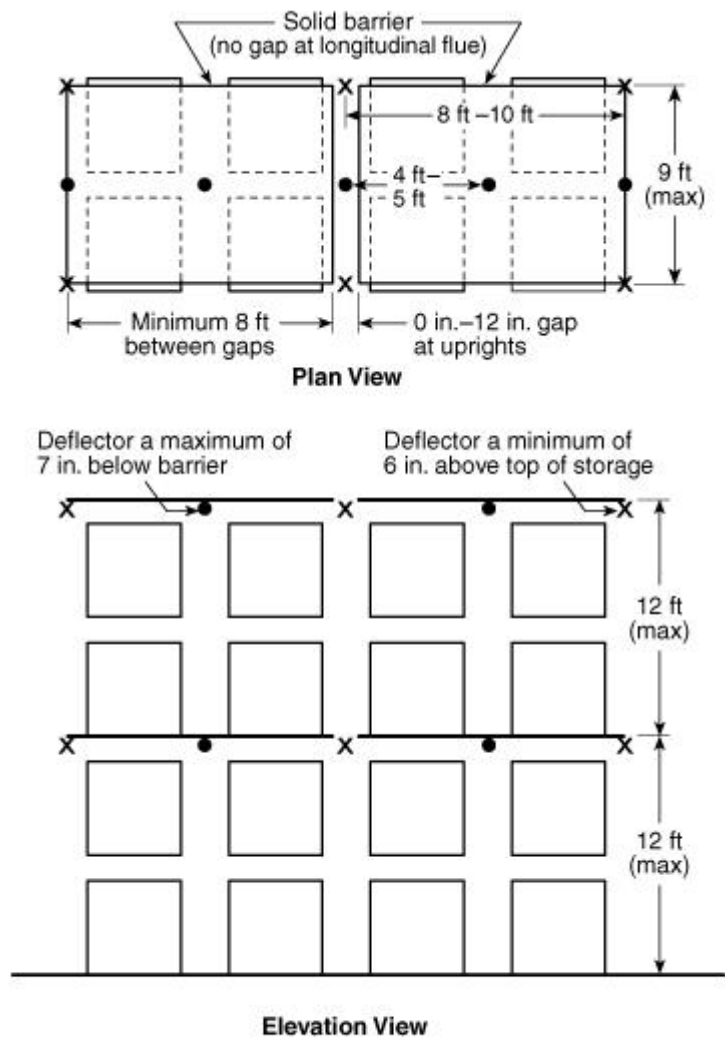

- Notes: (1) For SI units, 1 in. = 25 mm; 1 ft = 0.3 m.
 (2) ● denotes K-8.0, ordinary, QR longitudinal flue sprinkler.
 (3) X denotes K-8.0, ordinary, QR face sprinkler.

FIGURE 6.8.6.1(b) Double-Row Rack Sprinkler Layout.

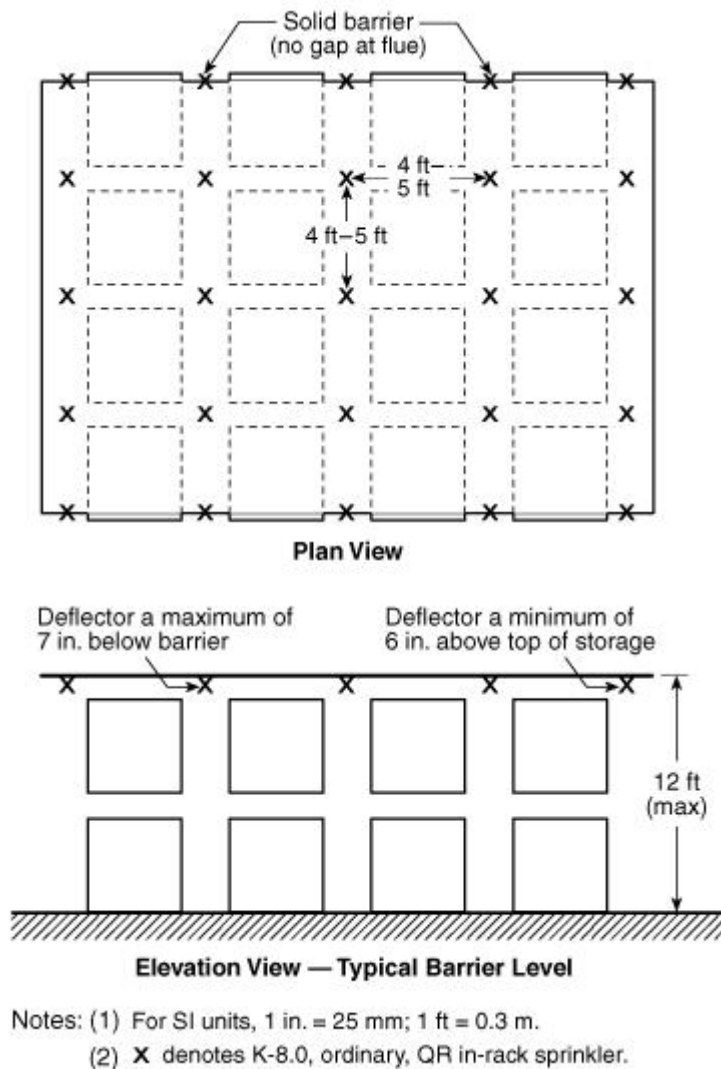

FIGURE 6.8.6.1.1(c) Multiple-Row Rack Sprinkler Layout.

6.8.6.1.2 Listed or approved K-8.0, ordinary temperature-rated quick-response in-rack sprinklers shall be installed below each barrier level. The in-rack sprinklers shall be designed to provide a minimum end head pressure of 345 kPa gauge (50 psig) out of the hydraulically most remote six sprinklers (three on two lines) if one barrier level, or the most remote eight sprinklers (four on two lines) if two or more barrier levels, are provided.

6.8.6.1.3 If there are adjacent bays of in-rack arrays not dedicated to storage of liquids, the barrier and in-rack sprinkler protection shall be extended at least 2.4 m (8 ft) beyond the area devoted to liquid storage. In addition, adjacent racks across the aisles on each side of the liquid storage shall be protected in accordance with this protection scheme.

6.8.6.1.4 Ceiling sprinkler demand shall not be included in the hydraulic calculations for in-rack sprinklers. Water demand at point of supply shall be calculated separately for in-rack and ceiling sprinklers and shall be based on the greater demand.

6.8.6.1.5 Ceiling sprinkler protection shall meet the following:

- (1) The ceiling sprinkler protection shall be designed to protect the surrounding occupancy.
- (2) Any sprinkler type shall be acceptable for the ceiling sprinkler protection.
- (3) If standard spray sprinklers are used, they shall be capable of providing not less than 8.1 L/min over 270 m² (0.20 gpm/ft² over 3000 ft²).
- (4) If the liquid storage does not extend to the full height of the rack, protection for commodities stored above the top horizontal barrier shall meet the requirements of NFPA 13, *Standard for the Installation of Sprinkler Systems*, for the commodities stored, based on the full height of the rack.

6.8.6.1.6 Barriers shall not be required for storage of liquids with a closed-cup flash point of 230°C (450°F) or greater. If barriers are omitted, the following modifications to the protection scheme shall be provided:

- (1) Ceiling sprinkler protection shall provide a minimum density of 0.3 gpm/ft² over the most hydraulically remote 2000 ft² (12.2 L/min/m² over 180 m²), using ordinary temperature, standard-response sprinklers with a nominal K-factor equal to or greater than 8.0.
- (2) The ceiling sprinkler water demand and the in-rack water demand shall be balanced at their point of connection.

6.8.6.1.7 A 1900 L/min (500 gpm) hose stream allowance shall be provided.

6.8.6.2 Fire Protection Scheme B.

6.8.6.2.1 Horizontal barriers of plywood of minimum 10 mm ($\frac{3}{8}$ in.) thickness or sheet metal of minimum 22 gauge and in-rack sprinklers shall be installed in accordance with Figure 6.8.6.2.1(a), Figure 6.8.6.2.1(b), or Figure 6.8.6.2.1(c). Vertical baffles shall not be provided between in-rack sprinklers.

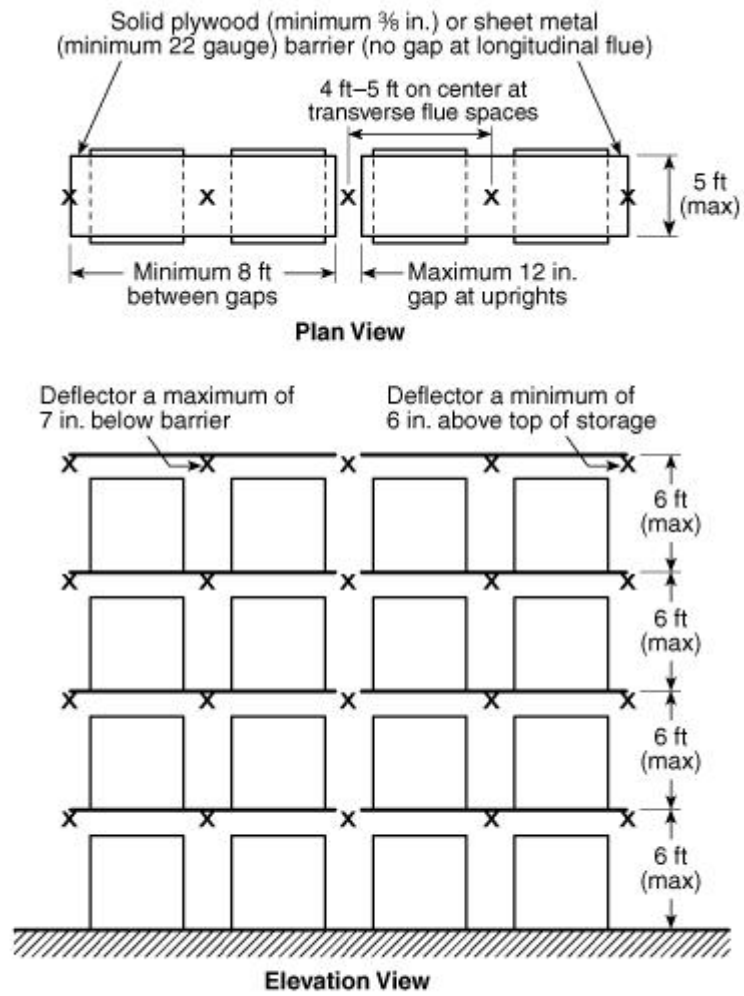

- Notes: (1) For SI units, 1 in. = 25 mm; 1 ft = 0.3 m.
 (2) X denotes K-8.0, ordinary, QR in-rack sprinkler.

FIGURE 6.8.6.2.1(a) Single-Row Rack Sprinkler Layout, Sprinklers in Center of Rack.

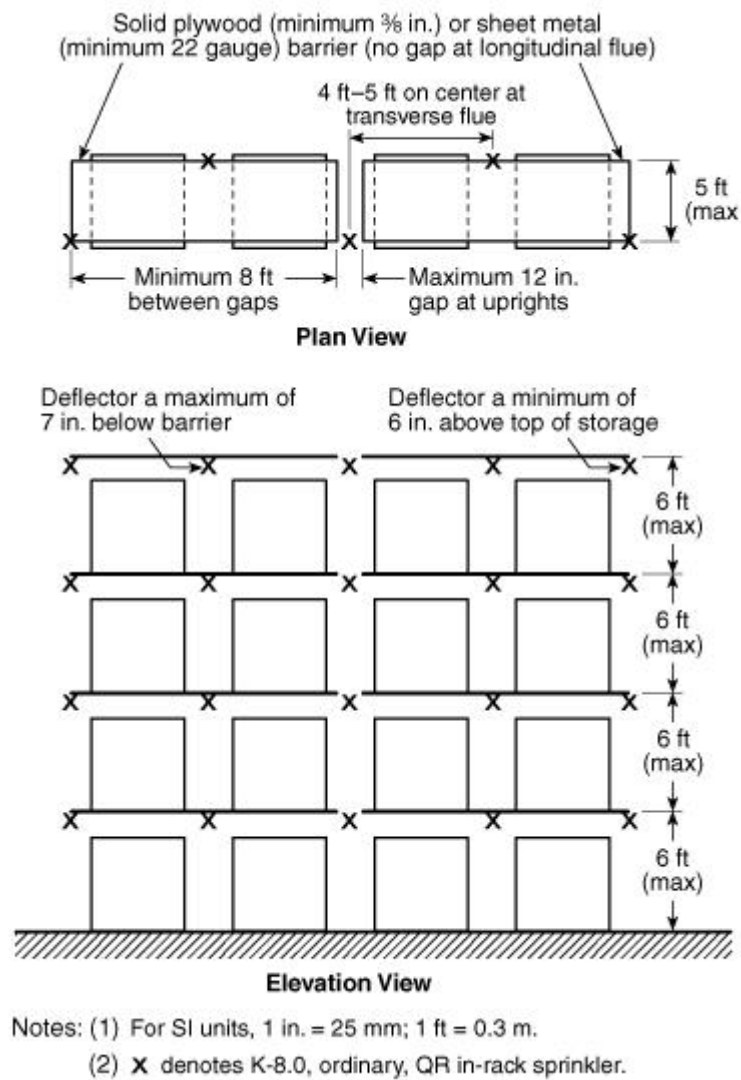

FIGURE 6.8.6.2.1(b) Single-Row Rack Sprinkler Layout, Sprinkler on Face of Rack.

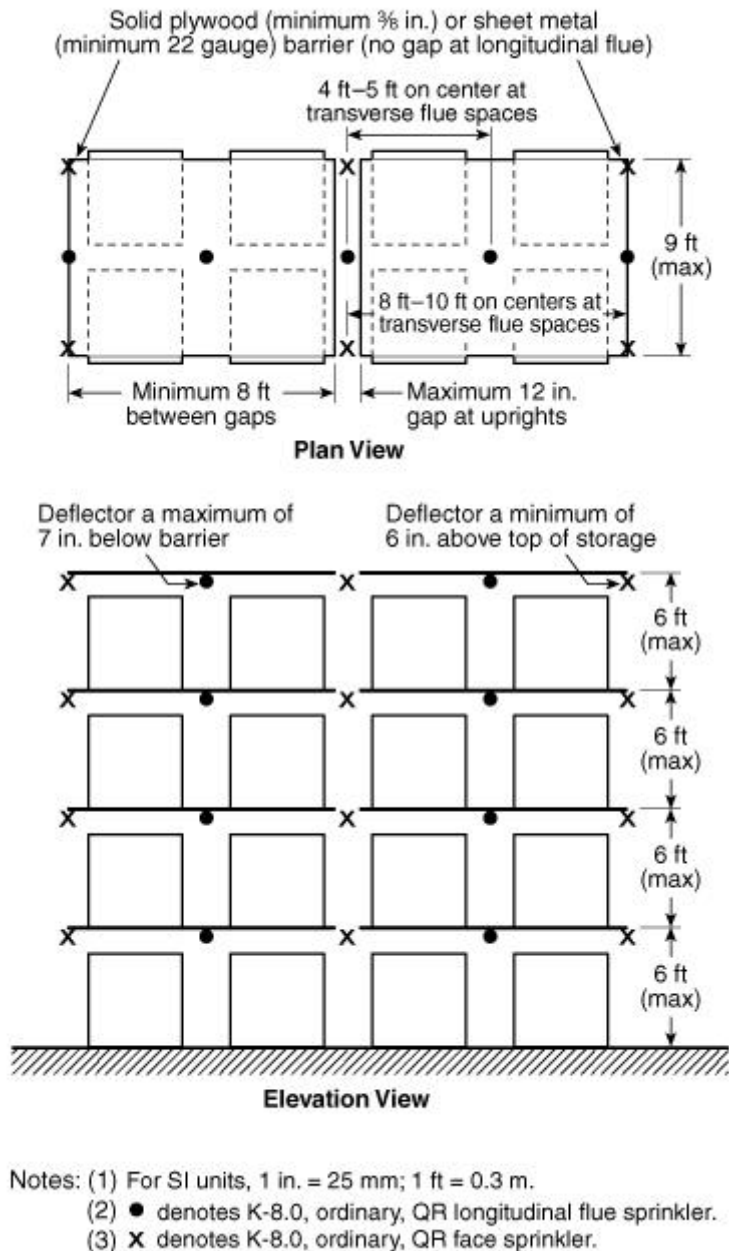

FIGURE 6.8.6.2.1(c) Double-Row Rack Sprinkler Layout.

6.8.6.2.2 In-rack sprinklers shall be nominal K-factor of 8.0, ordinary temperature-rated, quick-response sprinklers and shall be installed below each horizontal barrier. The design criteria of the in-rack sprinkler system shall meet the following:

- (1) For containers that do not exceed 230 L (60 gal) capacity and where there is only one horizontal barrier, the in-rack sprinkler system shall provide a minimum head pressure of 345 kPa gauge (50 psig) from the hydraulically most remote six sprinklers, three each on two lines. Where there are two or more horizontal barriers, the in-rack sprinkler system shall provide a minimum head pressure of 345 kPa gauge (50 psig)

from the hydraulically most remote eight sprinklers, four each on two lines.

- (2) For containers that exceed 230 L (60 gal) capacity, but do not exceed 3000 L (793 gal), the in-rack sprinkler system shall provide a minimum head pressure of 345 kPa gauge (50 psig) from the hydraulically most remote 12 sprinklers, six each on two lines.

6.8.6.2.3 If there are adjacent bays or racks that are not dedicated to storage of liquids, the barrier and in-rack sprinkler system shall be extended beyond the area devoted to liquid storage as follows:

- (1) For containers that do not exceed 3.8 L (1 gal) capacity, the protection shall be extended at least 2.4 m (8 ft) beyond the area devoted to liquid storage. In addition, adjacent racks across the aisles on each side of the liquid storage shall be protected in accordance with NFPA 13, *Standard for the Installation of Sprinkler Systems*, for the commodity stored.
- (2) For containers that exceed 3.8 L (1 gal) capacity, but do not exceed 3000 L (793 gal), the protection shall be extended at least 2.4 m (8 ft) beyond the area devoted to liquid storage. In addition, the protection shall be extended to protect adjacent racks across the aisles on each side of the liquid storage.

6.8.6.2.4 Ceiling sprinkler protection for containers that do not exceed 3.8 L (1 gal) capacity shall meet the following:

- (1) The ceiling sprinkler protection shall be designed to protect the surrounding occupancy.
- (2) The ceiling sprinkler water demand shall not be included in the hydraulic calculations for the in-rack sprinkler protection. Water demand at the point of supply shall be calculated separately for the in-rack and ceiling protection and shall be based on the greater of the two.
- (3) Any sprinkler type shall be acceptable for the ceiling sprinkler protection. If standard spray sprinklers are used, they shall be capable of providing not less than 8.1 L/min over 270 m² (0.20 gpm/ft² over 3000 ft²).
- (4) If the liquid storage does not extend to the full height of the rack, protection for commodities stored above the top horizontal barrier shall meet the requirements of NFPA 13, *Standard for the Installation of Sprinkler Systems*, for the commodities stored, based on the full height of the rack.

6.8.6.2.5 Ceiling sprinkler protection for containers that exceed 3.8 L (1 gal) capacity, but do not exceed 230 L (60 gal), shall meet the following:

- (1) The ceiling sprinkler protection shall provide a minimum density of 18.3 mm/min over the most hydraulically remote 270 m² (0.45 gpm/ft² over 3000 ft²), using high-temperature, standard-response sprinklers of nominal K-factor of 8.0 or 11.2. Other types of sprinklers shall not be used.
- (2) The ceiling sprinkler water demand and the in-rack sprinkler demand shall be

balanced at the point of connection.

6.8.6.2.6 Ceiling sprinkler protection for containers that exceed 230 L (60 gal) capacity, but do not exceed 3000 L (793 gal), shall meet the following:

- (1) The ceiling sprinkler protection shall be designed to provide a minimum density of 24.4 L/min over the most remote 270 ft² (0.60 gpm/ft² over 3000 ft²), using K-11.2 or K-8.0, high-temperature-rated, standard-response sprinklers. Other types of sprinklers shall not be accepted.
- (2) The ceiling sprinkler water demand and the in-rack sprinkler demand shall be balanced at the point of connection.

6.8.6.2.7 A 1900 L (500 gpm) water supply capacity shall be provided for hose streams.

6.8.6.3 In-Rack Sprinkler Layouts for Table 6.8.2(h). Figure 6.8.6.3(a) through Figure 6.8.6.3(e) shall be used to determine layout of in-rack sprinklers for Table 6.8.2(h).

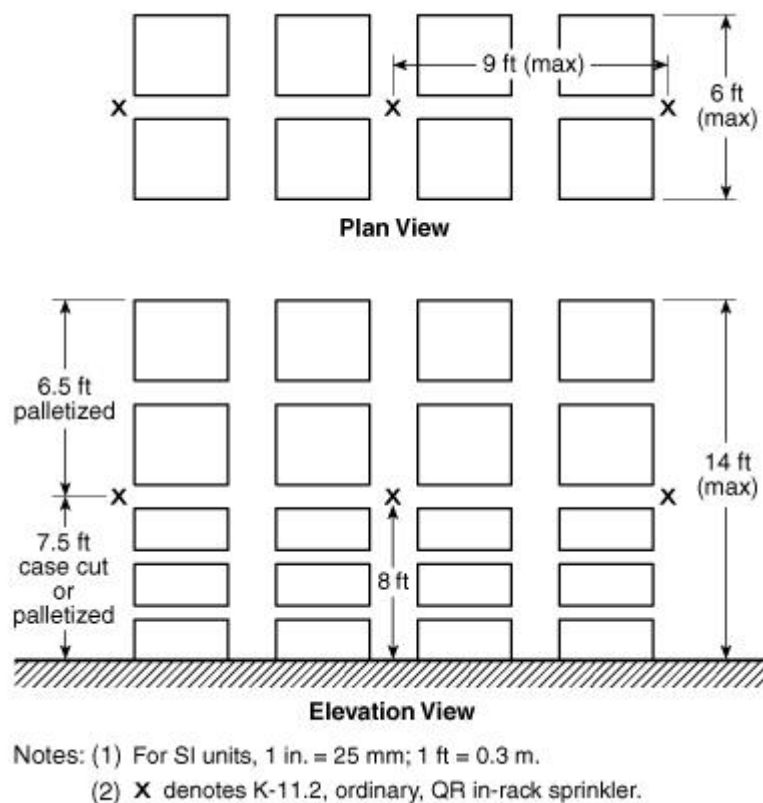
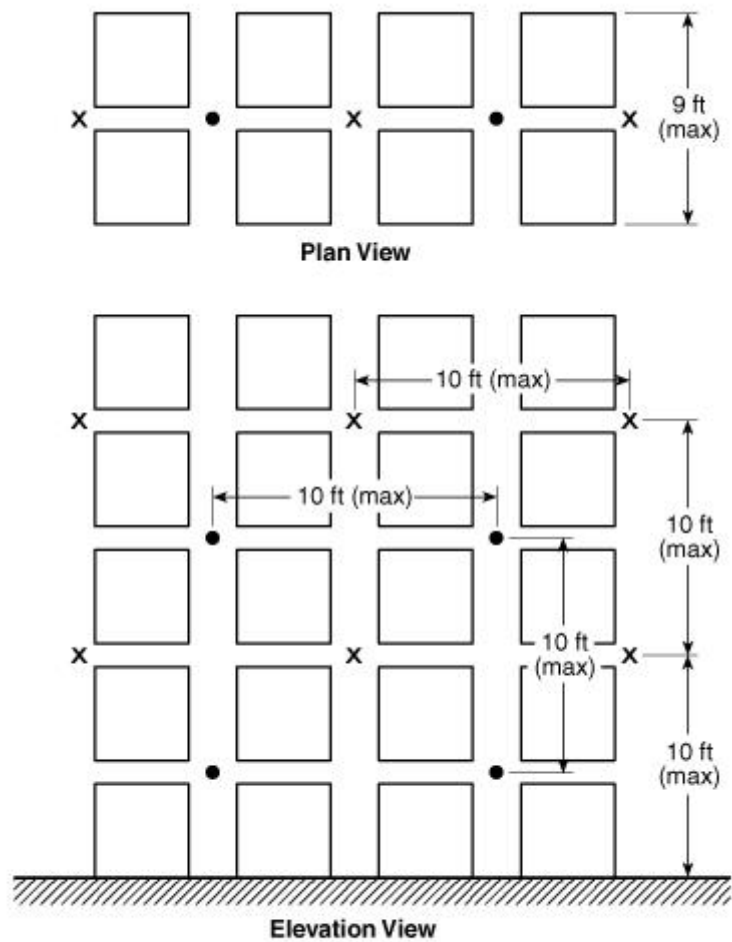
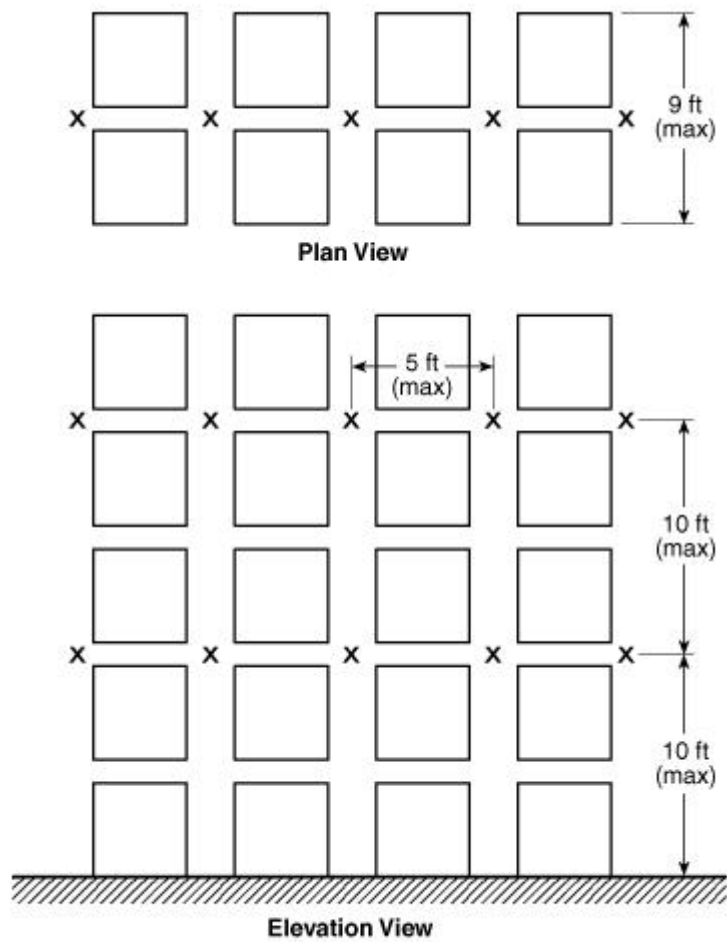

FIGURE 6.8.6.3(a) Modified Double-Row Rack Sprinkler Layout.



- Notes: (1) For SI units, 1 in. = 25 mm; 1 ft = 0.3 m.
 (2) ● and X denote K-8.0, QR in-rack sprinklers.

FIGURE 6.8.6.3(b) Double-Row Rack Sprinkler Layout.



Notes: (1) For SI units, 1 in. = 25 mm; 1 ft = 0.3 m.
 (2) X denotes K-8.0, QR in-rack sprinkler.

FIGURE 6.8.6.3(c) Double-Row Rack Sprinkler Layout.

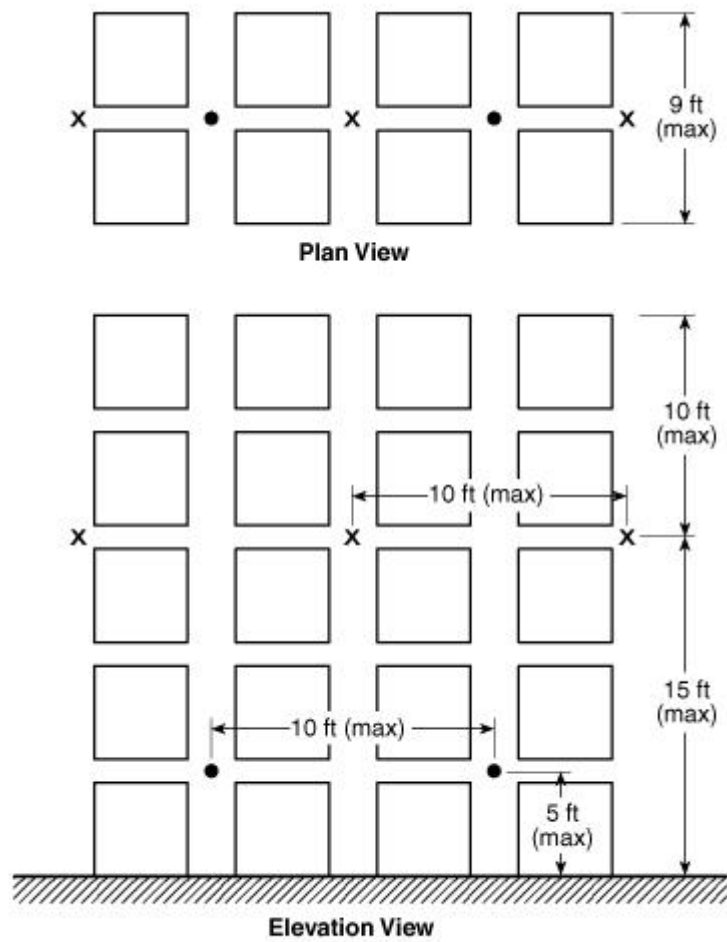

Notes: (1) For SI units, 1 in. = 25 mm; 1 ft = 0.3 m.
 (2) ● and X denote K-8.0, QR in-rack sprinklers.

FIGURE 6.8.6.3(d) Double-Row Rack Sprinkler Layout.

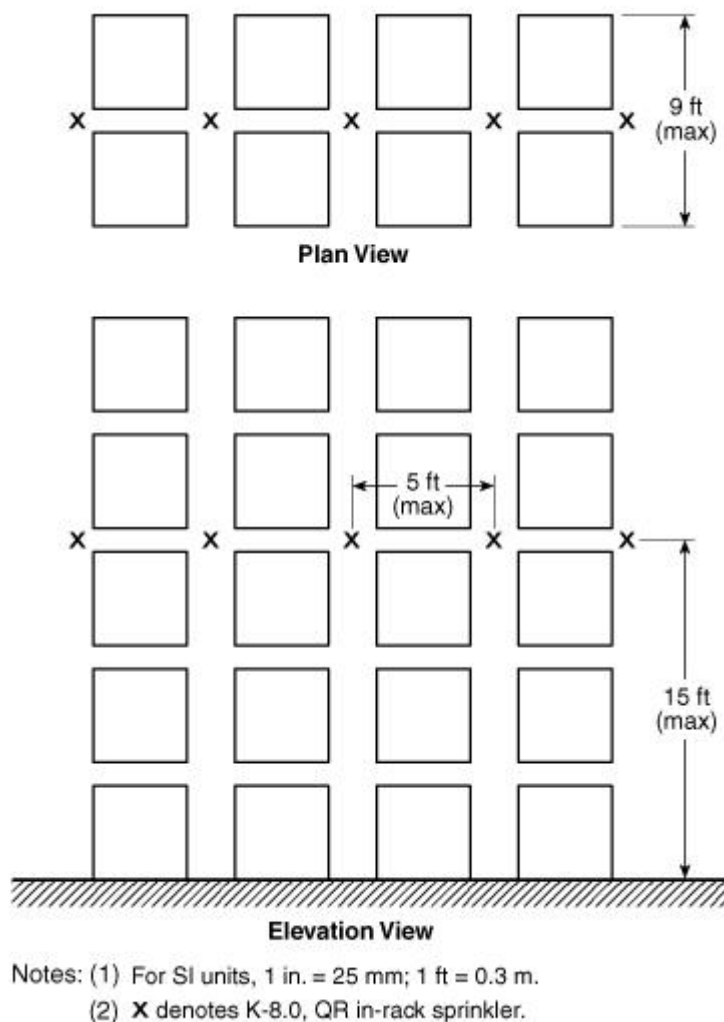

FIGURE 6.8.6.3(e) Double-Row Rack Sprinkler Layout.

6.9 Manual Fire Protection.

Portable fire extinguishers or pre-connected hoselines, either 38 mm (1½ in.) lined fire hose or 25 mm (1 in.) hard rubber hose, shall be provided where liquids are stored. If 38 mm (1½ in.) lined fire hose is used, it shall be installed in accordance with NFPA 14, *Standard for the Installation of Standpipe and Hose Systems*.

6.9.1 Portable fire extinguishers shall meet the following requirements:

- (1) At least one portable fire extinguisher having a capability of not less than 40:B shall be located outside of, but not more than 3 m (10 ft) from, the door opening into an inside liquid storage area.
- (2) At least one portable fire extinguisher having a capability of not less than 40:B shall be located within 9 m (30 ft) of any Class I or Class II liquid storage area that is located outside of an inside liquid storage area or liquid warehouse.

Exception: An acceptable alternative is at least one portable fire extinguisher having a

capacity of 80:B located within 15 m (50 ft) of such a storage area.

6.9.2 Hoseline connections shall meet the following requirements:

- (1) In protected general-purpose warehouses and in protected liquid storage areas, hoseline connections shall be provided as appropriate.
- (2) The water supply for hoseline connections shall be sufficient to meet the fixed fire protection demand plus a total of at least 1900 L/min (500 gpm) for inside and outside hoseline connections, unless otherwise specified in Table 6.8.2(a) through Table 6.8.2(k).
- (3) Water supplies for hose connections and hydrants shall be capable of supplying the demand for at least 2 hours.

6.10 Control of Ignition Sources.

Precautions shall be taken to prevent the ignition of flammable vapors from sources of ignition that include, but are not limited to, the following:

- (1) Open flames
- (2) Lightning
- (3) Smoking
- (4) Cutting or welding
- (5) Hot surfaces
- (6) Frictional heat
- (7) Static electricity
- (8) Electrical or mechanical sparks
- (9) Spontaneous heating, including heat-producing chemical reactions
- (10) Radiant heat

6.10.1* Materials that are water-reactive, as described in NFPA 704, *Standard System for the Identification of the Hazards of Materials for Emergency Response*, shall not be stored in the same area with other liquids.

6.10.2* Power-operated industrial trucks used to move Class I liquids shall be selected, operated, and maintained in accordance with NFPA 505, *Fire Safety Standard for Powered Industrial Trucks Including Type Designations, Areas of Use, Conversions, Maintenance, and Operation*.

Chapter 7 Operations

7.1 Scope.

7.1.1 This chapter shall apply to operations involving the use or handling of liquids either as
Copyright NFPA

a principal or incidental activity, except as covered elsewhere in this code or in other NFPA standards.

7.1.2* The provisions of this chapter shall relate to the control of hazards of fire involving liquids.

7.1.3 Provisions of this chapter shall not prohibit the use of movable tanks in conjunction with the dispensing of flammable or combustible liquids into fuel tanks of motorized equipment outside on premises not accessible to the public. Such uses shall only be made with the approval of the authority having jurisdiction.

7.2 General.

7.2.1 Liquid processing operations shall be located and operated so that they do not constitute a significant fire or explosion hazard to life, to property of others, or to important buildings or facilities within the same plant. Specific requirements shall be dependent on the inherent risk in the operations themselves, including the liquids being processed, operating temperatures and pressures, and the capability to control any liquid or vapor releases or fire incidents that could occur. The interrelationship of the many factors involved shall be based on good engineering and management practices to establish suitable physical and operating requirements.

7.2.2 Requirements for specific operations shall be covered in Section 7.4 through Section 7.8 and Section 7.10 and Section 7.11. Requirements for procedures and practices for fire prevention, fire protection, and fire control in these operations shall be covered in Section 7.9 through Section 7.12 and shall be applied as appropriate.

7.3 Facility Design.

7.3.1 Scope. Section 7.3 shall apply to operations where the handling and use of liquids is a principal activity. This section shall not apply to operations where the handling and use of liquids is incidental to the principal activity. (*See Section 7.5.*)

7.3.2 Location. Liquid processing vessels and equipment shall be located in accordance with the requirements of this subsection.

7.3.2.1 Processing vessels and buildings containing such processing vessels shall be located so that a fire involving the vessels does not constitute an exposure hazard to other occupancies. The minimum distance of a processing vessel to a property line that is or can be built upon, including the opposite side of a public way; to the nearest side of a public way; or to the nearest important building on the same property shall be as follows:

- (1) In accordance with Table 7.3.2.1
- (2) Determined by an engineering evaluation of the process, followed by application of sound fire protection and process engineering principles

Exception: Where process vessels are located in a building and the exterior wall facing the exposure (line of adjoining property that is or can be built upon or nearest important building on the same property) is greater than 7.6 m (25 ft) from the exposure and is a blank wall having a fire resistance rating of not less than 2 hours, any greater distances

required by Table 7.3.2.1 shall be permitted to be waived. If the exterior wall is a blank wall having a fire resistance rating of not less than 4 hours, all distances required by Table 7.3.2.1 shall be permitted to be waived.

Table 7.3.2.1 Location of Processing Vessels from Property Lines and Nearest Important Building Protection for Exposures Is Provided

Vessel Maximum Operating Liquid Capacity (gal)	Minimum Distance (ft)				
	From Property Line that Is or Can Be Built Upon, Including Opposite Side of Public Way				From Nearest Significant Building on Same Property
	Stable Liquid Emergency Relief		Unstable Liquid Emergency Relief		Stable Liquid Emergency
	Not Over 2.5 psig	Over 2.5 psig	Not Over 2.5 psig	Over 2.5 psig	Not Over 2.5 psig
275 or less	5	10	15	20	5
276 to 750	10	15	25	40	5
751 to 12,000	15	25	40	60	5
12,001 to 30,000	20	30	50	80	5
30,001 to 50,000	30	45	75	120	10
50,001 to 100,000	50	75	125	200	15
Over 100,000	80	120	200	300	25

Notes:

(1) For SI units, 1 gal = 3.8 L; 1 ft = 0.3 m; 1 psig = a gauge pressure of 6.9 kPa.

(2) Double all of above distances where protection for exposures is not provided.

7.3.2.2 Where Class IA liquids or unstable liquids, regardless of class, are handled or processed, the exposing walls shall have explosion resistance in accordance with recognized engineering standards. (See 7.3.3.7 for information on explosion relief of other building walls.)

7.3.2.3* Other liquid-processing equipment, such as pumps, heaters, filters, and exchangers, shall not be located closer than 7.6 m (25 ft) to property lines where the adjoining property is or can be built upon or to the nearest important building on the same property that is not an integral part of the process. This spacing requirement shall be permitted to be waived where exposures are protected as outlined in 7.3.2.1.

7.3.2.4 Processing equipment in which unstable liquids are handled shall be separated from unrelated plant facilities that use or handle liquids by either of the following:

- (1) 7.6 m (25 ft) clear spacing
- (2) A wall having a fire resistance rating of not less than 2 hours and explosion resistance consistent with the expected hazard

7.3.2.5 Each process unit or building containing liquid-processing equipment shall be accessible from at least one side for fire fighting and fire control.

7.3.3 Construction.

7.3.3.1* Process buildings or structures used for liquid operations shall be constructed consistent with the operations being conducted and with the classes of liquids handled. They shall be constructed in accordance with the requirements of this section and in accordance with Table 7.3.3.1.

Table 7.3.3.1 Construction of Buildings or Structures Used for Liquid Handling and Operations

Liquid Class	Minimum Separation Distance (ft)		
	To Adjacent Property Line that Is or Can Be Built Upon	To Street, Alley, or Public Way	Minimum Type Construction†
Class I liquids, unstable liquid	50	10	II (000)
of any class, and liquids of any class	25	5	II (111)
heated above their flash points	10	5	II (222)
Class II	25	5	II (000)
	10	5	II (111)
Class III	10	5	II (000)

Notes:

(1) For SI units, 1 ft = 0.3 m.

(2) Distances apply to properties that have protection for exposures, as defined in this code. If there are exposures for which protection does not exist, the distances shall be doubled.

†Construction types are defined in NFPA 220, *Standard on Types of Building Construction*.

7.3.3.1.1 Buildings or structures used solely for blending, mixing, or dispensing of Class IIIB liquids at temperatures below their flash points shall be permitted to be constructed of combustible construction, subject to the approval of the authority having jurisdiction.

7.3.3.1.2 Buildings or structures used for processing or handling of liquids where the quantities of liquids do not exceed 1360 L (360 gal) of Class I and Class II liquids and 2725 L (720 gal) of Class III liquids shall be permitted to be constructed of combustible construction, subject to the approval of the authority having jurisdiction.

7.3.3.1.3 Buildings or structures used for processing or handling of liquids protected with automatic sprinklers or equivalent fire protection systems shall be permitted to be constructed of combustible construction, subject to the approval of the authority having jurisdiction.

7.3.3.2* Load-bearing building supports and load-bearing supports of vessels and equipment capable of releasing appreciable quantities of liquids so as to result in a fire of sufficient intensity and duration to cause substantial property damage shall be protected by one or more of the following:

- (1) Drainage to a safe location to prevent liquids from accumulating under vessels or equipment
- (2) Fire-resistive construction
- (3) Fire-resistant protective coatings or systems
- (4) Water spray systems designed and installed in accordance with NFPA 15, *Standard for Water Spray Fixed Systems for Fire Protection*
- (5) Other alternate means acceptable to the authority having jurisdiction

7.3.3.3 Class I liquids shall not be handled or used in basements. Where Class I liquids are handled or used above grade within buildings with basements or closed pits into which flammable vapors can travel, such belowgrade areas shall be provided with mechanical ventilation designed to prevent the accumulation of flammable vapors. Means shall be provided to prevent liquid spills from running into basements.

7.3.3.4* Smoke and heat venting shall be permitted to be used where it assists access for fire fighting.

7.3.3.5* Areas shall have exit facilities arranged to prevent occupants from being trapped in the event of fire. Exits shall not be exposed by the drainage facilities described in 7.3.5.

7.3.3.6 Adequate aisles shall be maintained for unobstructed movement of personnel and fire protection equipment.

7.3.3.7* Areas where Class IA or unstable liquids are processed shall be designed to direct flame, combustion gases, and pressures resulting from a deflagration away from important buildings or occupied areas through the use of damage-limiting construction. The damage-limiting construction design shall be in accordance with recognized standards and shall be acceptable to the authority having jurisdiction. (*See A.6.4.2.4.*)

7.3.4 Ventilation.

7.3.4.1 Enclosed processing areas handling or using Class I liquids or Class II or Class III liquids, heated to temperatures at or above their flash points, shall be ventilated at a rate sufficient to maintain the concentration of vapors within the area at or below 25 percent of the lower flammable limit. Compliance with 7.3.4.2 through 7.3.4.5 shall be deemed as meeting the requirements of 7.3.4.1.

7.3.4.2* Ventilation requirements shall be confirmed by one of the following:

- (1) Calculations based on the anticipated fugitive emissions (*see Annex F for calculation method*).
- (2) Sampling of the actual vapor concentration under normal operating conditions. The sampling shall be conducted at a 1.5 m (5 ft) radius from each potential vapor source

extending to or toward the bottom and the top of the enclosed processing area. The vapor concentration used to determine the required ventilation rate shall be the highest measured concentration during the sampling procedure.

Exception: Where a ventilation rate of not less than 0.3 m³/min/m² (1 ft³/min/ft²) of solid floor area is provided, the ventilation confirmation requirement of 7.3.4.2 shall not apply.

7.3.4.3 Ventilation shall be accomplished by mechanical or natural exhaust ventilation. Exhaust ventilation discharge shall be to a safe location outside the building, without recirculation of the exhaust air.

Exception: Recirculation is permitted where it is monitored continuously using a fail-safe system that is designed to automatically sound an alarm, stop recirculation, and provide full exhaust to the outside in the event that vapor-air mixtures in concentrations over one-fourth of the lower flammable limit are detected.

7.3.4.4* Provision shall be made for introduction of make-up air in such a manner as to avoid short-circuiting the ventilation. Ventilation shall be arranged to include all floor areas or pits where flammable vapors can collect. Local or spot ventilation to control special fire or health hazards, if provided, shall be permitted to be utilized for up to 75 percent of the required ventilation.

7.3.4.5 Where equipment such as dispensing stations, open centrifuges, plate and frame filters, and open vacuum filters is used in a building, the equipment and ventilation of the building shall be designed to limit flammable vapor-air mixtures under normal operating conditions to the interior of equipment and to not more than 1.5 m (5 ft) from equipment that exposes Class I liquids to the air.

7.3.5 Drainage.

7.3.5.1* Emergency drainage systems shall be provided to direct liquid leakage and fire protection water to a safe location.

7.3.5.2 Emergency drainage systems, if connected to public sewers or discharged into public waterways, shall be equipped with traps or separators.

7.3.5.3 A facility shall be designed and operated to prevent the discharge of liquids to public waterways, public sewers, or adjoining property.

7.3.6 Electrical Equipment. Electrical wiring and utilization equipment shall meet the requirements of Chapter 8.

7.3.7 Liquid Handling, Transfer, and Use.

7.3.7.1 Class I liquids shall be kept in closed tanks or containers when not actually in use. Class II and Class III liquids shall be kept in closed tanks or containers when ambient or process temperature is at or above their flash point.

7.3.7.2 Where liquids are used or handled, provisions shall be made to promptly and safely dispose of leakage or spills.

7.3.7.3 Class I liquids shall not be used outside closed systems where there are open flames

or other ignition sources within the classified areas set forth in Chapter 8.

7.3.7.4 Transfer of liquids among vessels, containers, tanks, and piping systems by means of air or inert gas pressure shall be permitted only under all of the following conditions:

- (1) The vessels, containers, tanks, and piping systems shall be designed for such pressurized transfer and shall be capable of withstanding the anticipated operating pressure.
- (2) Safety and operating controls, including pressure-relief devices, shall be provided to prevent overpressure of any part of the system.
- (3) Only inert gas shall be used to transfer Class I liquids. Inert gas shall be used to transfer Class II and Class III liquids that are heated above their flash points.

7.3.7.5 Positive displacement pumps shall be provided with pressure relief discharging back to the tank, pump suction, or other suitable location or shall be provided with interlocks to prevent overpressure.

7.3.7.6 Piping, valves, and fittings shall be in accordance with Chapter 5.

7.3.7.7 Listed flexible connectors shall be permitted to be used where vibration exists. Approved hose shall be permitted to be used at transfer stations.

7.3.7.8* The staging of liquids in containers, intermediate bulk containers, and portable tanks shall be limited to the following:

- (1) Containers, intermediate bulk containers, and portable tanks that are in use
- (2) Containers, intermediate bulk containers, and portable tanks that were filled during a single shift
- (3) Containers, intermediate bulk containers, and portable tanks needed to supply the process for one continuous 24-hour period
- (4) Containers, intermediate bulk containers, and portable tanks that are stored in accordance with Chapter 6.

7.3.7.9 Intermediate bulk containers and portable tanks that contain Class I, Class II, or Class IIIA liquids used in a process and staged in the process area shall not be filled in the process area.

Exception No. 1: Intermediate bulk containers and portable tanks that meet the requirements of Chapter 6.

Exception No. 2: Intermediate products that are manufactured in the process area.

7.3.8* Equipment. Equipment shall be designed and arranged to prevent the unintentional escape of liquids and vapors and to minimize the quantity escaping in the event of accidental release.

7.4 Recirculating Heat Transfer Systems.

7.4.1 Scope. This section shall apply only to recirculating heat transfer systems that use a

heat transfer fluid that is heated up to or above its flash point under normal operation.

Exception: This section shall not apply to process streams or to any system of 230 L (60 gal) capacity or less.

7.4.2* General Requirements. A heater or vaporizer for heat transfer fluid that is located inside a building shall meet all applicable requirements of 7.3.2 through 7.3.8.

7.4.3* System Design.

7.4.3.1* Drainage shall be provided at strategic low points in the heat transfer system. Drains shall be piped to a safe location that is capable of accommodating the total capacity of the system or the capacity of that part of the system that is isolated.

7.4.3.2* Where the heat transfer system expansion tank is located above floor level and has a capacity of more than 950 L (250 gal), it shall be provided with a low-point drain line that can allow the expansion tank to drain to a drain tank on a lower level. The drain line valve shall be operable from a safe location.

7.4.3.3 A heat transfer fluid system shall not be used to provide direct building heat.

7.4.3.4 All pressure-relief device outlets shall be piped to a safe location.

7.4.4* Fuel Burner Controls and Interlocks. Oil- or gas-fired heaters or vaporizers shall be designed and installed in accordance with the applicable requirements of NFPA 31, *Standard for the Installation of Oil-Burning Equipment*, or NFPA 85, *Boiler and Combustion Systems Hazards Code*, whichever is applicable. Wood dust suspension-fired heaters or vaporizers shall be designed and installed in accordance with the applicable requirements of NFPA 85.

7.4.5 Piping.

7.4.5.1* Piping shall meet all applicable requirements of Chapter 5.

7.4.5.2 All pipe connections shall be welded. Welded threaded connections shall be permitted to be used for piping 50 mm (2 in.) and smaller.

Exception: Mechanical joints shall be permitted to be used at pump, valve, and equipment connections.

7.4.5.3 New piping that is to be insulated with permanent insulation and existing piping that has been disturbed and is to be reinsulated with permanent insulation shall be covered with a closed-cell, non-absorbent insulation material.

7.4.5.3.1 Where all pipe joints are welded and where there are no other points in the system subject to leakage, such as at valves or pumps, other types of insulation shall be permitted.

7.4.5.3.2 Where dams are formed around possible leak-producing areas, using metal “donut” flanges that are welded to the pipe or using a “donut” segment of non-absorbent insulation sealed to the pipe to prevent migration of leakage into adjacent insulation, the piping from dam to dam shall be considered to be a closed system and other types of insulation shall be permitted. The area subject to leakage where the dam has been constructed shall be insulated with non-absorbent insulation or a non-absorbent insulation

system.

7.4.5.3.3 Where removable, reusable insulated covers are required for access, the covers shall be fabricated of flexible or rigid insulation that is encapsulated in a manner to provide a non-absorbent insulation system to prevent absorption of leakage into the insulation.

7.4.6 Fire Protection.

7.4.6.1* Automatic sprinkler protection meeting the requirements of NFPA 13, *Standard for the Installation of Sprinkler Systems*, for Extra Hazard (Group I) Occupancies shall be provided for building areas containing a heat transfer system heater or vaporizer.

7.4.6.2 An alternate fire protection system shall be permitted to be used, if approved by the authority having jurisdiction. Such alternate system shall be designed and installed in accordance with the appropriate NFPA standard and with manufacturer's recommendations for the system selected.

7.4.7 Operation.

7.4.7.1* Operations involving heat transfer fluid systems and equipment shall be reviewed to ensure that the fire and explosion hazards resulting from loss of containment of the fluid or failure of the system are provided with corresponding fire prevention and emergency action plans.

7.4.7.2 Operators of heat transfer systems shall be trained in the hazards of system misoperation and leakage and shall be trained to recognize upset conditions that can lead to dangerous situations.

7.4.7.3 Safety interlocks shall be inspected, calibrated, and tested annually or at other intervals established in accordance with other appropriate standards to determine that they are in proper operating condition.

7.5 Incidental Operations.

7.5.1* This section shall apply to areas where the use, handling, and storage of liquids is only a limited activity to the established occupancy classification.

7.5.2 Class I liquids or Class II or Class III liquids that are heated up to or above their flash points shall be drawn from or transferred into vessels, containers, or portable tanks as follows:

- (1) From original shipping containers with a capacity of 20 L (5.3 gal) or less
- (2) From safety cans
- (3) Through a closed piping system
- (4) From portable tanks or containers by means of a device that has antisiphoning protection and that draws through an opening in the top of the tank or container
- (5) By gravity through a listed self-closing valve or self-closing faucet

7.5.2.1 If hose is used in the transfer operation, it shall be equipped with a self-closing valve without a hold-open latch in addition to the outlet valve. Only listed or approved hose shall

Copyright NFPA

be used.

7.5.2.2 Means shall be provided to minimize generation of static electricity. Such means shall meet the requirements of 7.9.4.

7.5.2.3 Where pumps are used for liquid transfer, means shall be provided to deactivate liquid transfer in the event of a liquid spill or fire.

7.5.3 All storage of liquids shall comply with Chapter 6.

Exception: As provided in 7.5.4 and 7.5.5.

7.5.4 The quantity of liquid located outside of identified storage areas, such as storage cabinets, other inside liquid storage areas, general-purpose warehouses, or other specific processing areas that are cut off from the general plant area by at least a 2-hour fire separation, shall meet the requirements of 7.5.4.1.

7.5.4.1 The aggregate of the sum of all incidental operations in each single fire area shall not exceed the sum of the following:

- (1) 95 L (25 gal) of Class IA liquids in containers
- (2) 454 L (120 gal) of Class IB, Class IC, Class II, or Class III liquids in containers
- (3) 6000 L (1586 gal) of any combination of the following:
 - (a) Class IB, IC, II, or IIIA liquids in metal portable tanks or metal intermediate bulk containers, each not exceeding 3000 L (793 gal)
 - (b) Class II or Class IIIA liquids in nonmetallic intermediate bulk containers, each not exceeding 3000 L (793 gal)
- (4) 20 portable tanks or intermediate bulk containers each not exceeding 3000 L (793 gal) of Class IIIB liquids

Exception: Where quantities of liquid in excess of the limits in 7.5.4.1(1) through 7.5.4.1(4) are needed to supply an incidental operation for one continuous 24-hour period, that greater quantity shall be allowed.

7.5.4.2 Where quantities of liquids in excess of the limits in 7.5.4.1 are necessary, storage shall be in tanks that meet all applicable requirements of Chapter 4 and Section 7.3.

7.5.5 Areas in which liquids are transferred from one tank or container to another container shall be provided with the following:

- (1) Separation from other operations that can represent an ignition source by distance or by fire-resistant construction
- (2) Drainage or other means to control spills
- (3)* Natural or mechanical ventilation that meets the requirements of 7.3.4

7.6 Loading and Unloading Operations and Facilities.

7.6.1 Section 7.6 shall apply to operations involving the loading or unloading of tank cars

and tank vehicles and the areas in facilities where these operations are conducted.

7.6.2 Bonding requirements, as specified as follows, shall not be required:

- (1) Where tank cars and tank vehicles are loaded exclusively with products that do not have static-accumulating properties, such as asphalts (including cutback asphalts), most crude oils, residual oils, and water-soluble liquids
- (2) Where no Class I liquids are handled at the loading facility and where the tank cars and tank vehicles loaded are used exclusively for Class II and Class III liquids
- (3) Where tank cars and tank vehicles are loaded or unloaded through closed connections

7.6.3* Tank vehicle and tank car loading and unloading facilities shall be separated from aboveground tanks, warehouses, other plant buildings, or the nearest line of adjoining property that can be built upon by a distance of at least 7.6 m (25 ft) for Class I liquids and at least 4.6 m (15 ft) for Class II and Class III liquids, measured from the nearest fill spout or transfer connection. These distances shall be permitted to be reduced if there is suitable protection for exposures. Buildings for pumps or shelters for personnel shall be permitted to be a part of the facility.

7.6.4* Loading and unloading facilities shall be provided with drainage systems or other means to contain spills.

7.6.5 A loading or unloading facility that has a canopy or roof that does not limit the dissipation of heat or dispersion of flammable vapors and does not restrict fire-fighting access and control shall be treated as an outdoor facility.

7.6.6* Loading and unloading facilities that are used to load liquids into tank vehicles through open domes shall be provided with a means for electrically bonding to protect against static electricity hazards. Such means shall consist of a metallic bond wire that is permanently electrically connected to the fill pipe assembly or to some part of the rack structure that is in electrical contact with the fill pipe assembly. The free end of this wire shall be provided with a clamp or an equivalent device for convenient attachment to some metallic part that is in electrical contact with the cargo tank of the tank vehicle. All parts of the fill pipe assembly, including the drop tube, shall form a continuous electrically conductive path.

7.6.7 Tank car facilities where flammable and combustible liquids are loaded or unloaded through open domes shall be protected against stray currents by permanently bonding the fill pipe to at least one rail and to the facility structure, if of metal. Multiple pipelines that enter the area shall be permanently bonded together. In addition, in areas where excessive stray currents are known to exist, all pipelines entering the area shall be provided with insulating sections to electrically isolate them from the facility piping.

Exception: These precautions shall not be required where only Class II or Class III liquids are handled and where there is no probability that tank cars will contain vapors from previous cargoes of Class I liquids.

7.6.8 Equipment such as piping, pumps, and meters used for the transfer of Class I liquids between storage tanks and the fill stem of the loading facility shall not be used for the

transfer of Class II or Class III liquids.

Exception No. 1: This provision shall not apply to water-miscible liquid mixtures where the class of the mixture is determined by the concentration of liquid in water.

Exception No. 2: This provision shall not apply where the equipment is cleaned between transfers.

7.6.9 Remote pumps located in underground tanks shall have a listed leak detection device installed on the pump discharge side that will indicate if the piping system is not essentially liquidtight. This device shall be checked and tested at least annually according to the manufacturer's specifications to ensure proper installation and operation.

7.6.10 Loading and Unloading of Tank Vehicles.

7.6.10.1 Liquids shall be loaded only into cargo tanks whose material of construction is compatible with the chemical characteristics of the liquid. The liquid being loaded shall also be chemically compatible with the liquid hauled on the previous load unless the cargo tank has been cleaned.

7.6.10.2 Before loading tank vehicles through open domes, a bonding connection shall be made to the vehicle or tank before dome covers are raised and shall remain in place until filling is completed and all dome covers have been closed and secured.

Exception: As modified by 7.6.2.

7.6.10.3 When transferring Class I liquids, engines of tank vehicles or motors of auxiliary or portable pumps shall be shut down during making and breaking hose connections. If loading or unloading is done without requiring the use of the motor of the tank vehicle, the motor shall be shut down throughout any transfer operations involving Class I liquids.

7.6.10.4* Filling through open domes into the tank cars that contain vapor-air mixtures within the flammable range or where the liquid being filled can form such a mixture shall be by means of a downspout that extends to within 150 mm (6 in.) of the bottom of the tank. This precaution shall not be required when loading liquids that are not accumulators of static electric charges.

7.6.10.5 When top loading a tank vehicle with Class I or Class II liquids without a vapor control system, valves used for the final control of flow shall be of the self-closing type and shall be manually held open except where automatic means are provided for shutting off the flow when the vehicle is full. Automatic shutoff systems shall be provided with a manual shutoff valve located at a safe distance from the loading nozzle to stop the flow if the automatic system fails. When top loading a tank vehicle with vapor control, flow control shall be in accordance with 7.6.10.7 and 7.6.10.8.

7.6.10.6 When bottom loading a tank vehicle, a positive means shall be provided for loading a predetermined quantity of liquid, together with a secondary automatic shutoff control to prevent overfill. The connecting components between the loading rack and the tank vehicle that are required to operate the secondary control shall be functionally compatible. The connection between the liquid loading hose or pipe and the truck piping shall be by means of a dry disconnect coupling.

7.6.10.7 When bottom loading a tank vehicle that is equipped for vapor control, but when vapor control is not used, the tank shall be vented to the atmosphere, at a height not lower than the top of the cargo tank of the vehicle, to prevent pressurization of the tank. Connections to the facility's vapor control system shall be designed to prevent the escape of vapor to the atmosphere when not connected to a tank vehicle.

7.6.10.8 When bottom loading is used, reduced flow rates (until the fill opening is submerged), splash deflectors, or other devices shall be used to prevent splashing and to minimize turbulence.

7.6.10.9 Metal or conductive objects, such as gauge tapes, sample containers, and thermometers, shall not be lowered into or suspended in a compartment while the compartment is being filled or immediately after cessation of pumping to permit the relaxation of charge.

7.6.11 Loading and Unloading of Tank Cars.

7.6.11.1 Liquids shall be loaded only into tank cars whose material of construction is compatible with the chemical characteristics of the liquid. The liquid being loaded shall also be chemically compatible with the liquid hauled on the previous load unless the tank car has been cleaned.

7.6.11.2* Filling through open domes into the tanks of tank vehicles that contain vapor-air mixtures within the flammable range, or where the liquid being filled can form such a mixture, shall be by means of a downspout that extends to within 150 mm (6 in.) of the bottom of the tank. This precaution shall not be required when loading liquids that are not accumulators of static electric charges.

7.6.11.3 When bottom loading is used, reduced flow rates (until the fill opening is submerged), splash deflectors, or other devices shall be used to prevent splashing and to minimize turbulence.

7.6.11.4 Metal or conductive objects, such as gauge tapes, sample containers, and thermometers, shall not be lowered into or suspended in a compartment while the compartment is being filled or immediately after cessation of pumping to permit the relaxation of charge.

7.6.12* Switch Loading. To prevent hazards due to a change in flash point of liquids, no tank car or tank vehicle that has previously contained a Class I liquid shall be loaded with a Class II or Class III liquid unless proper precautions are taken.

7.7 Wharves.

7.7.1 Section 7.7 shall apply to all wharves as defined in 3.3.50 whose primary purpose is the bulk transfer of liquids. General-purpose wharves that handle bulk transfer of liquids and other commodities shall meet the requirements of NFPA 307, *Standard for the Construction and Fire Protection of Marine Terminals, Piers, and Wharves*.

7.7.2 Section 7.7 shall not apply to the following:

- (1) Marine service stations, as covered in NFPA 30A, *Code for Motor Fuel Dispensing*

Facilities and Repair Garages

- (2) Marinas and boatyards, as covered in NFPA 303, *Fire Protection Standard for Marinas and Boatyards*
- (3) Wharves that handle liquefied petroleum gases, as covered in NFPA 59A, *Standard for the Production, Storage, and Handling of Liquefied Natural Gas (LNG)*, and NFPA 58, *Liquefied Petroleum Gas Code*

7.7.3 Incidental handling of packaged cargo of liquids and loading/unloading of general cargo, such as ships' stores, during transfer of liquids shall be conducted only when approved by the wharf supervisor and the senior officer of the vessel.

7.7.4 Wharves at which liquid cargoes are to be transferred in bulk to or from tank vessels shall be at least 30 m (100 ft) from any bridge over a navigable waterway or from any entrance to or superstructure of a vehicular or railroad tunnel under a waterway. The termination of the loading or unloading fixed piping shall be at least 60 m (200 ft) from any bridge or from any entrance to or superstructure of a tunnel.

7.7.5 The substructure and deck of the wharf shall be substantially designed for the use intended. The deck shall be permitted to be of any material that will afford the desired combination of flexibility, resistance to shock, durability, strength, and fire resistance. Heavy timber construction shall be permitted.

7.7.6 Tanks used exclusively for ballast water or Class II or Class III liquids shall be permitted to be installed on a suitably designed wharf.

7.7.7 Loading pumps capable of building up pressures that exceed the safe working pressure of cargo hose or loading arms shall be provided with bypasses, relief valves, or other arrangements to protect the loading facilities against excessive pressure. Relief devices shall be tested at least annually to determine that they function satisfactorily at their set pressure.

7.7.8 All pressure hose and couplings shall be inspected at intervals appropriate to their service. With the hose extended, the hose and couplings shall be tested using the in-service maximum operating pressure. Any hose showing material deterioration, signs of leakage, or weakness in its carcass or at the couplings shall be withdrawn from service and repaired or discarded.

7.7.9 Piping, valves, and fittings shall meet applicable requirements of Chapter 5 and shall also meet the following requirements:

- (1) Flexibility of piping shall be assured by appropriate layout and arrangement of piping supports so that motion of the wharf structure resulting from wave action, currents, tides, or the mooring of vessels will not subject the piping to excessive strain.
- (2) Pipe joints that depend on the friction characteristics of combustible materials or on the grooving of pipe ends for mechanical continuity of piping shall not be permitted.
- (3) Swivel joints shall be permitted to be used in piping to which hose are connected and for articulated swivel-joint transfer systems, provided the design is such that the mechanical strength of the joint will not be impaired if the packing materials should

fail, for example, by exposure to fire.

- (4) Each line conveying Class I or Class II liquids leading to a wharf shall be provided with a readily accessible block valve located on shore near the approach to the wharf and outside of any diked area. Where more than one line is involved, the valves shall be grouped in one location.
- (5) Means shall be provided for easy access to any cargo line valves that are located below the wharf deck.

7.7.10 Pipelines on wharves that handle Class I or Class II liquids shall be adequately bonded and grounded. If excessive stray currents are encountered, insulating flanges or joints shall be installed. Bonding and grounding connections on all pipelines shall be located on the wharf side of insulating flanges, if used, and shall be accessible for inspection. Bonding between the wharf and the vessel shall not be required.

7.7.11 Hose or articulated swivel-joint pipe connections used for cargo transfer shall be capable of accommodating the combined effects of change in draft and change in tide. Mooring lines shall be kept adjusted to prevent surge of the vessel from placing stress on the cargo transfer system. Hose shall be supported to avoid kinking and damage from chafing.

7.7.12 Material shall not be placed on wharves in such a manner as to obstruct access to fire-fighting equipment or important pipeline control valves. Where the wharf is accessible to vehicle traffic, an unobstructed roadway to the shore end of the wharf shall be maintained for access of fire-fighting apparatus.

7.7.13 Loading or unloading shall not commence until the wharf supervisor and the person in charge of the tank vessel agree that the tank vessel is properly moored and all connections are properly made.

7.7.14 Mechanical work shall not be performed on the wharf during cargo transfer, except under special authorization based on a review of the area involved, methods to be employed, and precautions necessary.

7.7.15 Sources of ignition shall be controlled during transfer of liquids. Vehicular traffic and mechanical work including, but not limited to, welding, grinding, and other hot work, shall not be performed during cargo transfer except as authorized by the wharf supervisor and the senior officer on the vessel. Smoking shall be prohibited at all times on the wharf during cargo transfer operations.

7.7.16 For marine terminals handling flammable liquids, Figure 7.7.16 shall be used to determine the extent of classified areas for the purpose of installation of electrical equipment.

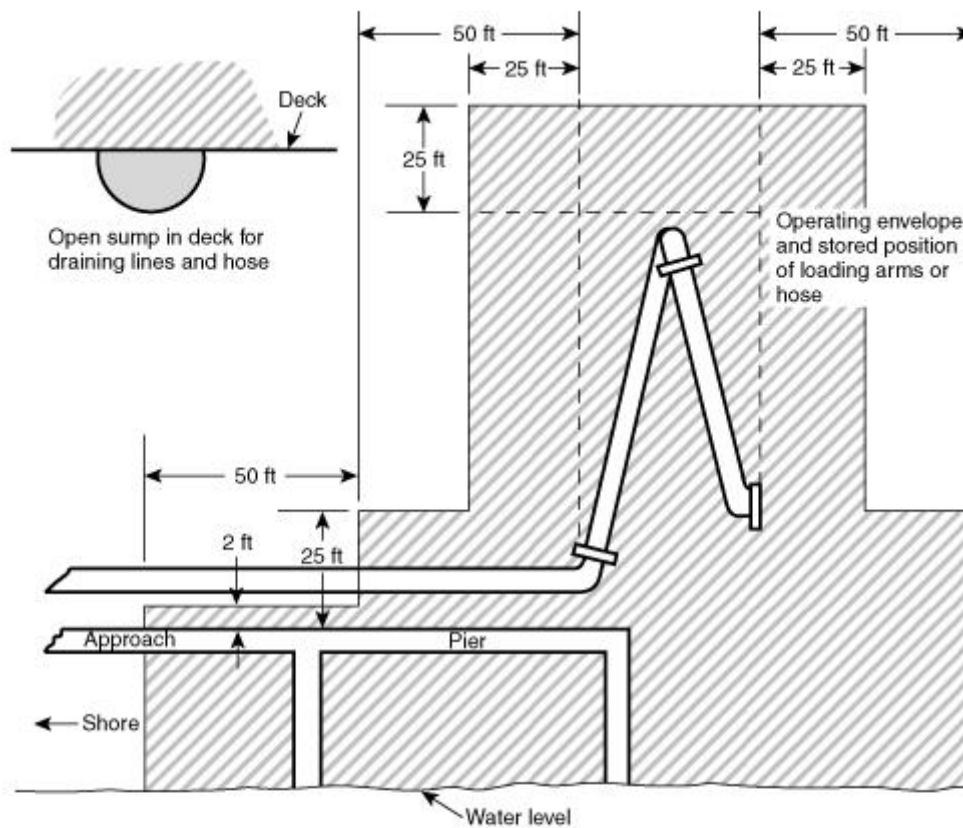

Key:

Division 1
 Division 2
 Nonclassified

Notes:

- (1) For SI units, 1 in. = 25 mm; 1 ft = 0.3 m.
- (2) The "source of vapor" is the operating envelope and stored position of the outboard flange connection of the loading arm (or hose).
- (3) The berth area adjacent to tanker and barge cargo tanks is to be Division 2 to the following extent:
 - (a) 25 ft (7.6 m) horizontally in all directions on the pier side from the portion of the hull containing cargo tanks.
 - (b) From the water level to 25 ft (7.6 m) above the cargo tanks at their highest position.
- (4) Additional locations can be classified as required by the presence of other sources of flammable liquids on the berth, or by Coast Guard or other regulations.

FIGURE 7.7.16 Marine Terminal Handling Flammable Liquids.

7.7.17 Where a flammable atmosphere can exist in the vessel cargo compartment, cargo transfer systems shall be designed to limit the velocity of the incoming liquid stream to 0.9 m (3 ft) per second until the compartment inlet opening is sufficiently submerged to prevent splashing.

7.7.18 Filters, pumps, wire screens, and other devices that can produce static electric charges through turbulence shall be so located to allow a minimum of 30 seconds relaxation

time prior to discharging cargo into the compartment.

7.7.19* Spill collection shall be provided around manifold areas to prevent spread of liquids to other areas of the wharf or under the wharf. Vapor seals shall be provided on all drain lines leaving the wharf.

7.7.20 Where required, wharves shall have a system to isolate and shut down the loading operation in the event of failure of a hose, loading arm, or manifold valve. This system shall meet all of the following requirements:

- (1) If the protective system closes a valve on a gravity-fed or pipeline-fed loading system, care shall be taken to ensure the line is protected from any resulting pressure surges.
- (2) Emergency shutdown systems shall be permitted to be automatically or manually activated. Manually activated device(s) shall be well marked and accessible during an emergency.

7.7.21* Fire protection for wharves shall be related to the products being handled, emergency response capability, size, location, frequency of use, and adjacent exposures.

7.7.21.1 Where a fire water main is provided, the main shall be permitted to be wet or dry. In all cases, isolation valves and fire department connections shall be provided at the wharf-to-shore connection.

7.7.21.2 Where a fire water main is provided, hydrants and monitors shall also be provided so that effective fire water streams can be applied to any berth or loading manifold from two directions.

7.7.21.3 Fire water pumps, fire hose, fire water mains, foam systems, and other fire suppression equipment shall be maintained and tested in accordance with NFPA 25, *Standard for the Inspection, Testing, and Maintenance of Water-Based Fire Protection Systems*.

7.7.21.4 Where no fire water main is provided, at least two 68 kg (150 lb) dry chemical extinguishers shall be provided. The extinguishers shall be located within 15 m (50 ft) of pump or manifold areas and shall be easily reached along emergency access paths.

7.8 Reserved.

7.9 Control of Ignition Sources.

7.9.1 General. Precautions shall be taken to prevent the ignition of flammable vapors by sources such as the following:

- (1) Open flames
- (2) Lightning
- (3) Hot surfaces
- (4) Radiant heat

- (5) Smoking
- (6) Cutting and welding
- (7) Spontaneous ignition
- (8) Frictional heat or sparks
- (9) Static electricity
- (10) Electrical sparks
- (11) Stray currents
- (12) Ovens, furnaces, and heating equipment

7.9.2 Smoking. Smoking shall be permitted only in designated and properly identified areas.

7.9.3* Hot Work. Welding, cutting, and similar spark-producing operations shall not be permitted in areas containing flammable liquids until a written permit authorizing such work has been issued. The permit shall be issued by a person in authority following his/her inspection of the area to assure that proper precautions have been taken and will be followed until the job is completed.

7.9.4* Static Electricity. All equipment such as tanks, machinery, and piping shall be designed and operated to prevent electrostatic ignitions.

7.9.4.1 All metallic equipment such as tanks, machinery, and piping where an ignitable mixture could be present shall be bonded or grounded. The bond or ground or both shall be physically applied or shall be inherently present by the nature of the installation. Any electrically isolated section of metallic piping or equipment shall be bonded or grounded to prevent hazardous accumulation of static electricity.

7.9.4.2 Nonmetallic equipment and piping shall be designed to provide equivalent safeguards against static electricity.

7.9.5 Electrical Installations. Electrical equipment and wiring installations shall be in accordance with Chapter 8.

7.10 Vapor Recovery and Vapor Processing Systems.

7.10.1 Scope.

7.10.1.1 Section 7.10 shall apply to vapor recovery and vapor processing systems where the vapor source operates at pressures from vacuum up to and including a gauge pressure of 6.9 kPa (1.0 psig), or where there is a potential for vapor mixtures in the flammable range.

7.10.1.2 Section 7.10 shall not apply to the following:

- (1) Marine systems that comply with U.S. DOT Regulations, 33 CFR 154, 155, and 156, and U.S. Coast Guard Regulations, 46 CFR 30, 32, 35, and 39
- (2) Marine and automotive service station systems that comply with NFPA 30A, *Code for Motor Fuel Dispensing Facilities and Repair Garages*

7.10.2 Overpressure/Vacuum Protection. Tanks and equipment shall have independent venting for overpressure or vacuum conditions that could occur from malfunction of the vapor recovery or vapor processing system.

Exception: For tanks, venting shall comply with 4.2.5.

7.10.3 Vent Location.

7.10.3.1 Vents on vapor processing systems shall be not less than 3.7 m (12 ft) from adjacent ground level, with outlets located and directed so that ignitable vapors will disperse to a concentration below the lower flammable limit before reaching any location that could contain an ignition source.

7.10.3.2 Vapor processing equipment and vents shall be located in accordance with 7.3.2.

7.10.4 Vapor Collection Systems.

7.10.4.1 Vapor collection piping shall be designed to prevent trapping liquid.

7.10.4.2 Vapor recovery and vapor processing systems that are not designed to handle liquid shall be provided with a means to eliminate any liquid that carries over to or condenses in the vapor collection system.

7.10.5* Liquid Level Monitoring.

7.10.5.1 A liquid knock-out vessel used in the vapor collection system shall have means to verify the liquid level and a high liquid level sensor that activates an alarm.

7.10.5.2 For unmanned facilities, the high liquid level sensor shall initiate shutdown of liquid transfer into the vessel and shutdown of vapor recovery or vapor processing systems.

7.10.6 Overfill Protection.

7.10.6.1 Storage tanks served by vapor processing or vapor recovery systems shall be equipped with overfill protection in accordance with 4.6.1.

7.10.6.2 Overfill protection of tank vehicles shall be in accordance with 7.6.10.5 through 7.6.10.7.

7.10.7 Sources of Ignition.

7.10.7.1 Vapor Release. Tank or equipment openings provided for purposes of vapor recovery shall be protected against possible vapor release in accordance with 4.3.3.4.6, 7.6.10.6, and 7.6.10.7.

7.10.7.2* Electric. Electrical area classification shall be in accordance with Chapter 8.

7.10.7.3* Static Electricity. Vapor collection and vapor processing equipment shall be protected against static electricity in accordance with 7.9.4.

7.10.7.4* Spontaneous Ignition. Where there is the potential for spontaneous ignition, precautions shall be taken either by design or written procedures to prevent ignition.

7.10.7.5* Friction Heat or Sparks from Mechanical Equipment. Mechanical equipment used to move vapors that are in the flammable range shall be designed to prevent sparks or

Copyright NFPA

other ignition sources under both normal and equipment malfunction conditions.

7.10.7.6* Flame Propagation. Where there is reasonable potential for ignition of a vapor mix in the flammable range, means shall be provided to stop the propagation of flame through the vapor collection system. The means chosen shall be appropriate for the conditions under which they will be used.

7.10.7.7 Explosion Protection. Where used, explosion protection systems shall comply with NFPA 69, *Standard on Explosion Prevention Systems*.

7.10.8 Emergency System Shutdown. Emergency shutdown systems shall be designed to fail to a safe position in the event of loss of normal system power (i.e., air or electric) or equipment malfunction.

7.11 Solvent Distillation Units.

7.11.1 Scope.

7.11.1.1 Section 7.11 shall apply to solvent distillation units having distillation chambers or still pots that do not exceed 230 L (60 gal) nominal capacity and are used to recycle Class I, Class II, and Class IIIA liquids.

7.11.1.2 This section shall not apply to research, testing, or experimental processes; to distillation processes carried out in petroleum refineries, chemical plants, or distilleries; or to distillation equipment used in dry cleaning operations.

7.11.2 Equipment. Solvent distillation units shall be approved or shall be listed in accordance with UL 2208, *Standard for Solvent Distillation Units*.

7.11.3 Solvents. Solvent distillation units shall only be used to distill liquids for which they have been investigated and which are indicated on the unit's marking or instruction manual. Unstable or reactive liquids or materials shall not be processed unless they have been specifically indicated on the system's markings or in the instruction manual.

7.11.4 Location. Solvent distillation units shall only be used in locations in accordance with their approval or listing. They shall not be used in basements. They shall be located away from potential sources of ignition, as indicated on the unit's marking.

7.11.5 Liquid Storage. Distilled liquids and liquids awaiting distillation shall be stored in accordance with Chapter 1 through Chapter 6.

7.12 Management of Fire Hazards.

7.12.1 Section 7.12 shall apply to the management methodology used to identify, evaluate, and control the hazards involved in processing and handling of flammable and combustible liquids. These hazards include, but are not limited to, preparation, separation, purification, and change of state, energy content, or composition.

7.12.2 Operations involving flammable and combustible liquids shall be reviewed to ensure that fire and explosion hazards resulting from loss of containment of liquids are provided with corresponding fire prevention and emergency action plans.

Exception No. 1: Operations where liquids are used solely for on-site consumption as fuels.

Exception No. 2: Operations where Class II or Class III liquids are stored in atmospheric tanks or transferred at temperatures below their flash points.

Exception No. 3: Mercantile occupancies, crude petroleum exploration, drillings, and well servicing operations, and normally unoccupied facilities in remote locations.

7.12.3 The extent of fire prevention and control that is provided shall be determined by means of an engineering evaluation of the operation and application of sound fire protection and process engineering principles. This evaluation shall include, but not be limited to, the following:

- (1) Analysis of the fire and explosion hazards of the operation
- (2) Analysis of emergency relief from process vessels, taking into consideration the properties of the materials used and the fire protection and control measures taken
- (3) Analysis of applicable facility design requirements in Section 7.3 through Section 7.7
- (4) Analysis of applicable requirements for liquid handling, transfer, and use, as covered in Section 7.3 through Section 7.7
- (5) Analysis of local conditions, such as exposure to and from adjacent properties and exposure to floods, earthquakes, and windstorms
- (6) Analysis of the emergency response capabilities of the local emergency services

7.12.4 A written emergency action plan that is consistent with available equipment and personnel shall be established to respond to fires and related emergencies. This plan shall include the following:

- (1) Procedures to be followed in case of fire, such as sounding the alarm, notifying the fire department, evacuating personnel, and controlling and extinguishing the fire.
- (2) Procedures and schedules for conducting drills of these procedures.
- (3) Appointment and training of personnel to carry out assigned duties. These duties shall be reviewed at the time of initial assignment, as responsibilities or response actions change, and whenever anticipated duties change.
- (4) Maintenance of fire protection equipment.
- (5) Procedures for shutting down or isolating equipment to reduce the release of liquid. This shall include assigning personnel responsible for maintaining critical plant functions or shutdown of plant processes.
- (6) Alternate measures for the safety of occupants.

7.12.5 The fire hazards management review conducted in accordance with 7.12.2 shall be repeated whenever the hazards leading to a fire or explosion change significantly. Conditions that might require repeating a review shall include, but are not limited to, the following:

- (1) When changes occur in the materials in process

- (2) When changes occur in process equipment
- (3) When changes occur in process control
- (4) When changes occur in operating procedures or assignments

7.13 Fire Protection and Fire Suppression.

7.13.1 General.

7.13.1.1* Section 7.13 shall cover the commonly recognized management control systems and methods used to prevent or minimize the loss from fire or explosion in liquid-processing facilities.

7.13.1.2* The authority having jurisdiction shall be consulted on specific cases or qualified engineering judgment shall be exercised.

7.13.2 Portable Fire Control Equipment.

7.13.2.1* Listed portable fire extinguishers shall be provided for facilities in such quantities, sizes, and types as could be needed for the special hazards of operation and storage.

7.13.2.2 When the need is indicated in accordance with 7.12.3, standpipe and hose systems, installed in accordance with NFPA 14, *Standard for the Installation of Standpipe and Hose Systems*, or hose connections from sprinkler systems using combination spray and straight stream nozzles, installed in accordance with NFPA 13, *Standard for the Installation of Sprinkler Systems*, shall be used.

7.13.2.3 When the need is indicated in accordance with 7.12.3, mobile foam apparatus shall be provided.

7.13.2.4 Automotive and trailer-mounted fire apparatus, where determined necessary, shall not be used for any purpose other than fire fighting.

7.13.3 Fixed Fire Control Equipment.

7.13.3.1 A reliable water supply or other suitable fire control agent shall be available in pressure and quantity to meet the fire demands indicated by the special hazards of operation, storage, or exposure.

7.13.3.2* Permanent connections between the fire water system and any process system shall be prohibited to prevent contamination of fire water with process fluids.

7.13.3.3* Hydrants, with or without fixed monitor nozzles, shall be provided in accordance with accepted practice. The number and placement shall depend on the hazard of the liquid-processing facility.

7.13.3.4* Where the need is indicated by the hazards of liquid processing, storage, or exposure as determined by 7.12.3, fixed protection shall be provided by means of approved sprinkler systems, water spray systems, deluge systems, fire-resistive materials, or a combination of these.

7.13.3.5 Where provided, fire control systems shall be designed, installed, and maintained in

accordance with the following NFPA standards:

- (1) NFPA 11, *Standard for Low-, Medium-, and High-Expansion Foam*
- (2) NFPA 11A, *Standard for Medium- and High-Expansion Foam Systems*
- (3) NFPA 12, *Standard on Carbon Dioxide Extinguishing Systems*
- (4) NFPA 12A, *Standard on Halon 1301 Fire Extinguishing Systems*
- (5) NFPA 16, *Standard for the Installation of Foam-Water Sprinkler and Foam-Water Spray Systems*
- (6) NFPA 17, *Standard for Dry Chemical Extinguishing Systems*

7.13.4 Detection and Alarm.

7.13.4.1* An approved means for prompt notification of fire or emergency to those within the plant and to the available public or mutual aid fire department shall be provided.

7.13.4.2 Those areas, including buildings, where a potential exists for a flammable liquid spill shall be monitored as appropriate. Some methods shall include the following:

- (1) Personnel observation or patrol
- (2) Process-monitoring equipment that would indicate a spill or leak could have occurred
- (3) Provision of gas detectors to continuously monitor the area where facilities are unattended

7.13.5 Emergency Planning and Training.

7.13.5.1 Personnel responsible for the use and operation of fire protection equipment shall be trained in the use of that equipment. Refresher training shall be conducted at least annually.

7.13.5.2 Planning of effective fire control measures shall be coordinated with local emergency response agencies.

7.13.5.3 Procedures shall be established to provide for safe shutdown of operations under emergency conditions. Provisions shall be made for periodic training, inspection, and testing of associated alarms, interlocks, and controls.

7.13.5.4 The emergency procedure shall be kept readily available in an operating area and updated regularly.

7.13.5.5 Where premises are likely to be unattended for considerable periods of time, a summary of the emergency plan shall be posted or located in a strategic and accessible location.

7.13.6 Inspection and Maintenance.

7.13.6.1 All fire protection equipment shall be properly maintained, and periodic inspections and tests shall be done in accordance with both standard practice and the equipment manufacturer's recommendations. Water-based fire protection systems shall be inspected, tested, and maintained in accordance with NFPA 25, *Standard for the Inspection, Testing,*
Copyright NFPA

and Maintenance of Water-Based Fire Protection Systems.

7.13.6.2 Maintenance and operating practices shall control leakage and prevent spillage of flammable liquids.

7.13.6.3 Combustible waste material and residues in operating areas shall be kept to a minimum, stored in covered metal containers, and disposed of daily.

7.13.6.4 Ground areas around facilities where liquids are stored, handled, or used shall be kept free of weeds, trash, or other unnecessary combustible materials.

7.13.6.5 Aisles established for movement of personnel shall be maintained clear of obstructions to permit orderly evacuation and ready access for manual fire-fighting activities.

Chapter 8 Electrical Equipment and Installations

8.1 Scope.

This chapter shall apply to areas where Class I liquids are stored or handled and to areas where Class II or Class III liquids are stored or handled at or above their flash points.

8.2 General.

Any electrical equipment provided shall not constitute a source of ignition for the flammable vapor that might be present under normal operation or during a spill. Compliance with 8.2.1 through 8.2.4 shall be deemed as meeting the requirements of Section 8.2.

8.2.1 All electrical equipment and wiring shall be of a type specified by and installed in accordance with NFPA 70, *National Electrical Code (NEC)*.

8.2.2* So far as it applies, Table 8.2.2 shall be used to delineate and classify areas for the purpose of installation of electrical equipment under normal conditions. In the application of classified areas, a classified area shall not extend beyond a floor, wall, roof, or other solid partition that has no openings within the classified area. The designation of classes, divisions, and zones shall be as defined in NFPA 70, *National Electrical Code*, Chapter 5, Article 500.

Table 8.2.2 Electrical Area Classification

Location	<i>NEC Class I</i>		
	Division	Zone	
Indoor equipment installed in accordance with Section 7.3 where flammable vapor–air mixtures can exist under normal operation	1	0	The entire area associated with the equipment, where the vapor is present continuously or frequently
	1	1	Area within 5 ft of any edge of such equipment
	2	2	Area between 5 ft and 8 ft from any edge of such equipment, also, space up to 3 ft above any edge of such equipment

Table 8.2.2 Electrical Area Classification

Location	NEC Class I		
	Division	Zone	
Outdoor equipment of the type covered in Section 7.3 where flammable vapor–air mixtures can exist under normal operation	1	0	The entire area associated present continuously or fi
	1	1	Area within 3 ft of any ec
	2	2	Area between 3 ft and 8 ft also, space up to 3 ft above any edge of such equipment
Tank storage installations inside buildings	1	1	All equipment located be
Tank — aboveground	2	2	Any equipment located a
	1	0	Inside fixed-roof tank
	1	1	Area inside dike where d for more than 50 percent
Shell, ends, or roof and dike area	2	2	Within 10 ft from shell, c wall
Vent	1	0	Area inside of vent pipin
	1	1	Within 5 ft of open end c
	2	2	Area between 5 ft and 10
Floating roof			
With fixed outer roof	1	0	Area between the floating
With no fixed outer roof	1	1	Area above the floating r
Underground tank fill opening	1	1	Any pit, box, or space be 1 or 2 classified location
	2	2	Up to 18 in. above grade connection and within a l
Vent — discharging upward	1	0	Area inside of vent pipin
	1	1	Within 3 ft of open end c
	2	2	Area between 3 ft and 5 ft
Tank Vault — Interior	1	1	Entire interior volume, if
Drum and container filling — outdoors or indoors	1	0	Area inside the drum or c
	1	1	Within 3 ft of vent and fi
	2	2	Area between 3 ft and 5 ft to 18 in. above floor or g opening
Pumps, bleeders, withdrawal fittings			
Indoor	2	2	Within 5 ft of any edge o above floor or grade leve
Outdoor	2	2	Within 3 ft of any edge o above grade level within
Pits and sumps			
Without mechanical ventilation	1	1	Entire area within a pit o classified location
With adequate mechanical ventilation	2	2	Entire area within a pit o classified location
Containing valves, fittings, or piping, and not within a Division 1 or 2 or Zone 1 or 2 classified location	2	2	Entire pit or sump
Drainage ditches, separators, impounding basins			

Table 8.2.2 Electrical Area Classification

Location	NEC Class I		
	Division	Zone	
Outdoor	2	2	Area up to 18 in. above d within 15 ft horizontally
Indoor			Same classified area as p
Tank vehicle and tank car ²			
Loading through open dome	1	0	Area inside of the tank
	1	1	Within 3 ft of edge of do
	2	2	Area between 3 ft and 15
Loading through bottom connections with atmospheric venting	1	0	Area inside of the tank
	1	1	Within 3 ft of point of ve
	2	2	Area between 3 ft and 15 directions; also, up to 18 of loading connection
Office and rest rooms		Ordinary	If there is any opening to the room shall be classifi
Loading through closed dome with atmospheric venting	1	1	Within 3 ft of open end c
	2	2	Area between 3 ft and 15 within 3 ft of edge of do
Loading through closed dome with vapor control	2	2	Within 3 ft of point of co directions
Bottom loading with vapor control or any bottom unloading	2	2	Within 3 ft of point of co grade within a horizontal
Storage and repair garage for tank vehicles	1	1	All pits or spaces below f
	2	2	Area up to 18 in. above f
Garages for other than tank vehicles		Ordinary	If there is any opening to location, the entire room point of the opening
Outdoor drum storage		Ordinary	
Inside rooms or storage lockers used for the storage of Class I liquids	2	2	Entire room
Indoor warehousing where there is no flammable liquid transfer		Ordinary	If there is any opening to the room shall be classifi
Piers and wharves			See Figure 7.7.16

Note: For SI units, 1 in. = 25 mm; 1 ft = 0.3 m.

¹The release of Class I liquids can generate vapors to the extent that the entire building, and possibly an area s
Zone 2 location.

²When classifying extent of area, consideration shall be given to the fact that tank cars or tank vehicles can be
loading or unloading positions shall be used.

8.2.3 The area classifications listed in Table 8.2.2 are based on the premise that the installation shall meet the applicable requirements of this code in all respects. Should this not be the case, the authority having jurisdiction shall have the authority to classify the extent of the area.

8.2.4* Where the provisions of 8.2.1 through 8.2.4 require the installation of electrical

equipment suitable for Class I, Division 1 or 2 or Zone 1 or 2 locations, ordinary electrical equipment, including switchgear, shall be permitted to be used if installed in a room or enclosure that is maintained under positive pressure with respect to the classified area. Ventilation make-up air shall not be contaminated.

Annex A Explanatory Material

Annex A is not a part of the requirements of this NFPA document but is included for informational purposes only. This annex contains explanatory material, numbered to correspond with the applicable text paragraphs.

A.1.1.1 This code is recommended for use as the basis for legal regulations. Its provisions are intended to reduce the hazard to a degree consistent with reasonable public safety, without undue interference with public convenience and necessity, of operations that require the use of flammable and combustible liquids. Compliance with this code does not eliminate all hazards in the use of flammable and combustible liquids. *(See the Flammable and Combustible Liquids Code Handbook for additional explanatory information.)*

A.1.1.2(1) Liquids that are solid at 37.8°C (100°F) or above, but are handled, used, or stored at temperatures above their flash points, should be reviewed against pertinent sections of this code.

A.1.1.2(3) Certain mixtures of flammable or combustible liquids and halogenated hydrocarbons either do not exhibit a flash point using the standard closed-cup test methods or will exhibit elevated flash points. However, if the halogenated hydrocarbon is the more volatile component, preferential evaporation of this component can result in a liquid that does have a flash point or has a flash point that is lower than the original mixture. In order to evaluate the fire hazard of such mixtures, flash point tests should be conducted after fractional evaporation of 10, 20, 40, 60, or even 90 percent of the original sample or other fractions representative of the conditions of use. For systems such as open process tanks or spills in open air, an open-cup test method might be more appropriate for estimating the fire hazard.

A.1.1.2(4) See NFPA 30B, *Code for the Manufacture and Storage of Aerosol Products*.

A.1.1.3(1) Requirements for transportation of flammable and combustible liquids are found in NFPA 385, *Standard for Tank Vehicles for Flammable and Combustible Liquids*, and in 49 CFR 100–199.

A.1.1.3(2) See NFPA 31, *Standard for the Installation of Oil-Burning Equipment*.

A.1.2 Requirements for the safe storage and use of the great variety of flammable and combustible liquids commonly available depend primarily on their fire characteristics, particularly the flash point, which is the basis for the classification system given in Section 1.7. It should be noted that a liquid's classification can be changed by contamination. For example, placing a Class II liquid into a tank that last contained a Class I liquid can change the flash point of the former so that it falls into the range of a Class I liquid. The same situation can exist where a Class II liquid is exposed to the vapors of a Class I liquid via an

interconnecting vapor line. (See 5.7.1.3 and 5.7.2.7.) Care should be exercised in such cases to apply the requirements appropriate to the actual classification. Refer to *Fire Protection Guide to Hazardous Materials* or *NFPA Haz-Mat Quick Guide*, for flash point and other fire hazard data.

The volatility of a liquid is increased by heating. Where Class II or Class III liquids are exposed to storage conditions, use conditions, or process operations where they are naturally or artificially heated up to or above their flash points, additional fire safety features, such as ventilation, separation from ignition sources, diking, or electrical area classification, might be necessary.

Additional fire safety considerations might also be necessary for the safe storage and use of liquids that have unusual burning characteristics, that are subject to self-ignition when exposed to air, that are highly reactive with other substances, that are subject to explosive decomposition, or that have other special properties that dictate safeguards over and above those specified for a normal liquid of similar flash point classification.

A.1.4 An existing situation involving a distinct hazard to life or adjacent property includes conditions that might result in an explosion or sudden escalation of a fire. Examples include but are not limited to inadequate ventilation of confined spaces, lack of adequate emergency venting of a tank, failure to fireproof the supports of elevated tanks, or lack of drainage or dikes to control spills.

A.1.7.2.1 At the boiling point, the surrounding atmospheric pressure can no longer hold the liquid in the liquid state and the liquid boils. A low boiling point is indicative of a high vapor pressure and a high rate of evaporation.

A.1.7.2.2 Flash point is a direct measure of a liquid's ability to emit flammable vapors. The lower the flash point, the greater the risk of fire. Flash point is determined using one of several different test procedures and apparatus that are specified in 1.7.4.

A liquid that has a flash point at or below ambient temperature is easy to ignite and will burn quickly. On ignition, the spread of flame over the surface of such a liquid will be rapid, because it is not necessary for the fire to expend energy heating the liquid to generate more vapor. Gasoline is a familiar example. A liquid with a flash point above ambient temperature presents less risk because it must be heated to generate enough vapor to become ignitable; it is more difficult to ignite and presents less potential for the generation and spread of vapor. A common example is home heating oil (Fuel Oil No. 2). Home heating oil must be atomized to a fine mist in order for it to be easily ignited.

Certain solutions of liquids in water exhibit a flash point using the standard closed-cup test procedures but will not burn and could even extinguish a fire. To assist identifying such solutions, the following standards are helpful:

- (1) ASTM D 4207, *Standard Test Method for Sustained Burning of Low Viscosity Liquid Mixtures by the Wick Test*
- (2) ASTM D 4206, *Standard Test Method for Sustained Burning of Liquid Mixtures Using the Small Scale Open-Cup Apparatus*

Liquid mixtures that do not sustain combustion for a specified time at a specified

Copyright NFPA

temperature are considered to be noncombustible. The tests described in the references listed in (1) and (2) provide additional data for determining proper storage and handling of such mixtures. In a confined space, such mixtures could still create an ignitable vapor–air mixture, depending on the amount of flammable liquid in the mixture and the quantity of the spill.

Related to the flash point is the fire point. The fire point of a liquid is the temperature at which ignition of vapors will result in continued burning. As the term *flash point* suggests, the vapors generated at that temperature will flash but will not necessarily continue to burn. The difference between flash point and fire point has some significance when conducting flash point tests [see 6.1.2 references to ASTM D 92, *Standard Test Method for Flash and Fire Points by Cleveland Open Cup*, and 49 CFR (U.S. Department of Transportation *Hazardous Materials Regulations*), *Method of Testing for Sustained Combustibility*.] However, a closed-cup flash point is used to classify the liquid and characterize its hazard.

For more information, see ASTM E 502, *Standard Test Method for Selection and Use of ASTM Standards for the Determination of Flash Point of Chemicals by Closed Cup Methods*, and the *ASTM Manual on Flash Point Standards and Their Use*.

A.1.7.2.4 Vapor pressure is a measure of the pressure that the liquid exerts against the atmosphere above it. Just as the atmosphere exerts pressure on the surface of the liquid, the liquid pushes back. Vapor pressure is normally less than atmospheric pressure and is a measure of the liquid’s tendency to evaporate (i.e., to move from the liquid to the gaseous state). This tendency is also referred to as volatility, thus the use of the term *volatile* to describe liquids that evaporate very easily. The higher the vapor pressure, the greater the rate of evaporation and the lower the boiling point. Simply put, this means more vapors and increased fire risk.

A.1.7.3 The classification of liquids is based on flash points that have been corrected to sea level, in accordance with the relevant ASTM test procedures. At high altitudes, the actual flash points will be significantly lower than those either observed at sea level or corrected to atmospheric pressure at sea level. Allowances could be necessary for this difference in order to appropriately assess the risk.

Table A.1.7.3 presents a comparison of the definitions and classification of flammable and combustible liquids, as set forth in Section 1.7 of this code, with similar definitions and classification systems used by other regulatory bodies.

The Hazardous Materials Regulations of the U.S. Department of Transportation (DOT), as set forth in the 49 CFR 173.120(b)(2) and 173.150(f), provide an exception whereby a flammable liquid that has a flash point between 37.8°C (100°F) and 60.5°C (141°F) and does not also meet the definition of any other DOT hazard class can be reclassified as a combustible liquid [i.e., one having a flash point above 60.5°C (141°F)] for shipment by road or rail within the United States.

Table A.1.7.3 Comparative Classification of Li

Agency	Agency Classification	Agency Flash Point		NFPA Definition	NFPA Classification
		°F	°C		

Table A.1.7.3 Comparative Classification of Li

Agency	Agency Classification	Agency Flash Point		NFPA Definition	NFPA Classification
		°F	°C		
ANSI/CMA Z129.1-1994	Flammable	<141	<60.5	Flammable Combustible	Class I Class II Class IIIA
	Combustible	≥ 141 to <200	≥ 60.5 to <93	Combustible	Class IIIA
DOT	Flammable	<141	<60.5	Flammable Combustible	Class I Class II Class IIIA
	Combustible	≥ 141 to <200	≥ 60.5 to <93	Combustible	Class IIIA
DOT HM-181 Domestic Exemption ¹	Flammable	<100	<37.8	Flammable	Class I
	Combustible	≥ 100 to <200	≥ 37.8 to <93	Combustible	Class II Class IIIA
UN	Flammable	<141	<60.5	Flammable Combustible	Class I Class II Class IIIA
	Combustible	≥ 141 to <200	≥ 60.5 to <93	Combustible	Class II Class IIIA
OSHA	Flammable	<100	<37.8	Flammable	Class I
	Combustible ²	≥ 100	≥ 37.8	Combustible	Class II Class IIIA Class IIIB ²

¹See A.1.7.3.

²See 29 CFR 1910.106 for Class IIIB liquid exemptions.

A.1.7.3.2 For the purposes of this code, a material with a Reid Vapor Pressure greater than 2068 mm Hg absolute (40 psia) is considered to be a gas and is, therefore, not within the scope of NFPA 30. See NFPA 58, *Liquefied Petroleum Gas Code*.

A.3.2.1 Approved. The National Fire Protection Association does not approve, inspect, or certify any installations, procedures, equipment, or materials; nor does it approve or evaluate testing laboratories. In determining the acceptability of installations, procedures, equipment, or materials, the authority having jurisdiction may base acceptance on compliance with NFPA or other appropriate standards. In the absence of such standards, said authority may require evidence of proper installation, procedure, or use. The authority having jurisdiction may also refer to the listings or labeling practices of an organization that is concerned with product evaluations and is thus in a position to determine compliance with appropriate standards for the current production of listed items.

A.3.2.2 Authority Having Jurisdiction. The phrase “authority having jurisdiction,” or its acronym AHJ, is used in NFPA documents in a broad manner, since jurisdictions and approval agencies vary, as do their responsibilities. Where public safety is primary, the authority having jurisdiction may be a federal, state, local, or other regional department or individual such as a fire chief; fire marshal; chief of a fire prevention bureau, labor department, or health department; building official; electrical inspector; or others having statutory authority. For insurance purposes, an insurance inspection department, rating bureau, or other insurance company representative may be the authority having jurisdiction. In many circumstances, the property owner or his or her designated agent assumes the role of the authority having jurisdiction; at government installations, the commanding officer or departmental official may be the authority having jurisdiction.

A.3.2.3 Code. The decision to designate a standard as a “code” is based on such factors as the size and scope of the document, its intended use and form of adoption, and whether it contains substantial enforcement and administrative provisions.

A.3.2.5 Listed. The means for identifying listed equipment may vary for each organization concerned with product evaluation; some organizations do not recognize equipment as listed unless it is also labeled. The authority having jurisdiction should utilize the system employed by the listing organization to identify a listed product.

A.3.3.5 Boil-Over. Boil-over occurs when the residues from surface burning become more dense than the unburned oil and sink below the surface to form a hot layer, which progresses downward much faster than the regression of the liquid surface. When this hot layer, called a “heat wave,” reaches water or water-in-oil emulsion in the bottom of the tank, the water is first superheated and then boils almost explosively, overflowing the tank. Oils subject to boil-over consist of components having a wide range of boiling points, including both light ends and viscous residues. These characteristics are present in most crude oils and can be produced in synthetic mixtures.

A boil-over is an entirely different phenomenon from a slop-over or froth-over. Slop-over involves a minor frothing that occurs when water is sprayed onto the hot surface of a burning oil. Froth-over is not associated with a fire but results when water is present or enters a tank containing hot viscous oil. Upon mixing, the sudden conversion of water to steam causes a portion of the tank contents to overflow.

A.3.3.6.2 Important Building. Examples of important buildings might include occupied buildings where egress within 2 minutes cannot be reasonably expected, and control buildings that require presence of personnel for orderly shutdown of important or hazardous processes. Important buildings can also include unprotected storage where products from fire can harm the community or the environment, or buildings that contain high-value contents or critical equipment or supplies.

A.3.3.7 Container. This correlates with the U.S. Department of Transportation definition of non-bulk container.

A.3.3.17 Fugitive Emissions. These include leaks from pump seals, valve packing, flange gaskets, compressor seals, process drains, etc.

A.3.3.18 Hazardous Material or Hazardous Chemical. These dangers can arise from but are not limited to toxicity, reactivity, instability, or corrosivity.

A.3.3.20 Hazardous Reaction or Hazardous Chemical Reaction. These dangers might include, but are not limited to, toxic effects, reaction speed (including detonation), exothermic reaction, or production of unstable or reactive materials.

A.3.3.25.5 Water-Miscible Liquid. Liquids that are water-miscible include low molecular weight (3 carbons or less) alcohols, such as methyl alcohol, ethyl alcohol, n-propyl alcohol, isopropyl alcohol, and allyl alcohol. Acetone and tert-butyl alcohol are also water-miscible.

When water-miscible flammable liquids are mixed with water, a homogeneous solution is formed. The flash point, fire point, heat of combustion, and heat release rate for the solution will be different from the pure liquid. The flash point and fire point of the solution will increase as the water concentration increases. At a certain water concentration, which varies for different liquids, the fire point will no longer exist and the solution will no longer present a fire hazard.

A.3.3.28 Occupancy Classification. This can include, but is not limited to, distillation, oxidation, cracking, and polymerization.

A.3.3.31 Pier. The terms *pier* and *wharf* are used interchangeably.

A.3.3.34 Process or Processing. The sequence can be inclusive of both physical and chemical operations, unless the term is modified to restrict it to one or the other. The sequence can involve, but is not limited to, preparation, separation, purification, or change in state, energy content, or composition.

A.3.3.41.2 Atmospheric Tank. Older style flat roof tanks were designed to operate at pressures from atmospheric through a gauge pressure of 3.5 kPa (0.5 psig), measured at the top of the tank. This limitation was established to avoid continuous stress on the roof plates of the tank.

A.3.3.45 Vapor Processing System. Examples are systems using blower-assist for capturing vapors and refrigeration, absorption, and combustion systems for processing vapors.

A.3.3.46 Vapor Recovery System. Examples are balanced-pressure vapor displacement systems and vacuum-assist systems without vapor processing.

A.3.3.48 Ventilation. Ventilation can be achieved by introduction of fresh air to dilute contaminated air or by local exhaust of contaminated air. Ventilation is considered adequate if it is sufficient to prevent accumulation of significant quantities of vapor-air mixtures in concentrations over one-fourth of the lower flammable limit.

A.3.3.49 Warehouse. Warehousing operations referred to in these definitions are those operations not accessible to the public and include general purpose, merchandise, distribution, and industrial warehouse-type operations.

A.3.3.50 Wharf. The terms *wharf* and *pier* are used interchangeably.

A.4.2.3.3.2 Such pressure vessels are generally referred to as “state special.”

A.4.2.4.1 The design of the supporting structure for tanks such as spheres is outside the scope of this code and requires special engineering consideration. See Appendix N of API 620, *Recommended Rules for the Design and Construction of Large, Welded, Low-Pressure Storage Tanks*.

A.4.2.5.1.9 Liquid properties that justify omitting such devices include, but are not limited to, condensation, corrosiveness, crystallization, polymerization, freezing, or plugging. When any of these conditions exist, consideration should be given to heating, use of devices that employ special materials of construction, use of liquid seals, or inerting. See NFPA 69, *Standard on Explosion Prevention Systems*.

A.4.2.5.2.3 An engineering evaluation should be performed whenever two-phase flow is anticipated. The objective of the engineering evaluation determining emergency vent requirements and design of the relief system is to protect against catastrophic failure resulting in unacceptable risk to persons or to the facility. Factors that should be included in the evaluation are as follows:

- (1) Properties of the materials including evaluated influence of two-phase flow and thermally induced instability. See the following references from the Design Institute for Emergency Relief Systems of the Center for Chemical Process Safety/American Institute of Chemical Engineers:
 - (a) Fisher, H. G. and Forrest, H. S., "Protection of Storage Tanks from Two-Phase Flow Due to Fire Exposure," *Process Safety Progress*, Vol. 14, July 1995, pp. 183-199.
 - (b) Houser, J., et al, "Vent Sizing for Fire Considerations: External Fire Duration, Jacketed Vessels, and Heat Flux Variations Owing to Fuel Consumption," *Journal of Loss Prevention in the Process Industries*, Vol. 14 No. 5, September 2001, pp. 403-412.
 - (c) Guidelines for Pressure Relief and Effluent Handling Systems, American Institute of Chemical Engineers/Center for Chemical Process Safety, New York, NY, 1998.
- (2) Rate of heat input to the tank and contents. Computer models such as PLGS (supported by the UK Health and Safety Executive) can be useful in making the analysis.
- (3) Fire duration. For pool fires this analysis can be based on burning rate and pool depth. Computer programs can be useful in making this analysis.

A.4.2.5.2.4 The formula shown in 4.2.5.2.4 is based on the following:

$$Q = 21,000(A)^{0.82}$$

where:

$$Q = \text{Btu/hr}$$

$$A = \text{ft}^2$$

Copyright NFPA

A.4.2.5.2.6 Exception Nos. 1 and 2 are based on full scale testing that demonstrated that ethyl alcohol and liquids having similar burning characteristics required less emergency venting capacity.

Ethyl alcohol (ethanol) has a heat of combustion of 26.8 MJ/kg (11,548 Btu/lb) and a rate of burning of 0.015 kg/m²/sec (0.000626 lb/ft²/sec). The burning rate was calculated based on pan pool fires of diameters between 0.2 m (0.7 ft) and 5.0 m (16.5 ft). The pool fires were burning at steady state in a wind-free environment. The ratio of the lip height of the pan (freeboard) to the diameter of the pan was approximately 0.06. Details of these tests can be found in “Fire Tests of Distilled Spirit Storage Tanks,” Client Report CR-5727.1, for the Association of Canadian Distillers.

A.4.2.5.2.9.2 The following is a suitable formula for this calculation:

$$CFH = 1667C_f A \sqrt{P_t - P_a}$$

where:

CFH = venting requirement (ft³ of free air per hour)

C_f = flow coefficient of 0.5

A = orifice area (in.²)

P_t = absolute pressure inside the tank (in. of water)

P_a = absolute atmospheric pressure outside the tank (in. of water)

A.4.2.5.2.10 Vent sizing formulae and prescriptive vent sizes, such as those established by UL 142, *Standard for Steel Aboveground Tanks for Flammable and Combustible Liquids*, are typically based on the direct installation of a venting device on to a tank with a nipple not exceeding 300 mm (12 in.). When the outlet of a vent must be extended to a remote location, such as for tanks located in buildings, which require vent discharges to be located outside, a significant reduction in vent flow can occur unless the size of the vent and connecting piping is increased. In such cases, the size of vents and vent pipe extensions should be calculated to ensure that a tank will not be over-pressurized during a fire exposure.

A.4.2.5.3 The required venting capacity depends upon the filling or withdrawal rate, whichever is greater, and the vent line length. Unrestricted vent piping sized in accordance with Table 4.2.5.3 will prevent back pressure development in tanks from exceeding a gauge pressure of 17.2 kPa (2.5 psi).

A.4.2.6 Other means of internal corrosion protection include protective coatings and linings and cathodic protection.

A.4.2.6.1.1(1) Acceptable design standards for cathodic protection systems include the following:

- (1) API RP 1632, *Cathodic Protection of Underground Petroleum Storage Tanks and Piping Systems*
- (2) ULC-S603.1 M, *Standard for Galvanic Corrosion Protection Systems for Steel Underground Tanks for Flammable and Combustible Liquids*

- (3) STI-P₃, *Specification and Manual for External Corrosion Protection of Underground Steel Storage Tanks*
- (4) NACE RP-0169, *Recommended Practice, Control of External Corrosion on Underground or Submerged Metallic Piping Systems*
- (5) NACE RP-0285, *Recommended Practice, Corrosion Control of Underground Storage Tank Systems by Cathodic Protection*
- (6) UL 1746, *Standard for External Corrosion Protection Systems for Steel Underground Storage Tanks, Part 1*
- (7) STI RP 892, *Recommended Practice for Corrosion of Underground Piping Networks Associated with Liquid Storage and Dispensing Systems*

A.4.2.6.1.1(2) See UL 1316, *Standard for Glass-Fiber-Reinforced Plastic Underground Storage Tanks for Petroleum Products, Alcohols, and Alcohol-Gasoline Mixtures*; UL 1746, *Standard for External Corrosion Protection Systems for Steel Underground Storage Tanks*; and STI ACT-100, *Specification for External Corrosion Protection of FRP Composite Steel Underground Tanks*, F894.

A.4.2.6.1.2 See API RP 1615, *Installation of Underground Petroleum Storage Systems*, for further information.

A.4.3.1.1 Appendix E of API Standard 650, *Welded Steel Tanks for Oil Storage*, and Appendix B of API 620, *Recommended Rules for the Design and Construction of Large, Welded, Low-Pressure Storage Tanks*, provide information on tank foundations.

A.4.3.1.3 For further information, see ASTM E 119, *Standard Test Methods for Fire Tests of Building Construction and Materials*, and UL 1709, *Standard for Rapid Rise Fire Tests of Protection Materials for Structural Steel*.

A.4.3.2 See PEI RP200, *Recommended Practices for Installation of Aboveground Storage Systems for Motor Vehicle Fueling*, for additional information.

A.4.3.2.3.2(B) An aboveground storage tank dike is normally sized to contain the entire contents of the largest single tank within it. Some designs incorporate sufficient freeboard (additional capacity) to accommodate precipitation or fire-fighting water. The amount of this freeboard is usually governed by local conditions.

A.4.3.2.3.2(D) Diked areas for tanks containing Class I liquids located in extremely porous soils might require special treatment to prevent seepage of hazardous quantities of liquids to low-lying areas or waterways in case of spills.

A.4.3.2.3.2(F)(3) Because unstable liquids will react more rapidly when heated than when at ambient temperatures, subdivision by drainage channels is the preferred method.

A.4.3.2.3.4.1 As noted in the Exception, engineering designs that can reduce exposure hazards include use of sealed sleeve piping and secondary containment piping to prevent leakage and the use of remotely controlled isolation valves on product lines to stop the flow of liquids when the piping is subjected to fire exposure.

A.4.3.2.3.4.3 Methods of preventing an exposure hazard include intermediate diking, drainage, or fire protection features such as water spray systems, monitors, or fire-resistive coatings. High integrity pumps or equipment also constitute a method of limiting exposure hazards.

A.4.3.2.5.4 Examples of liquids with minimal potential for accumulation of static charge include crude oil, asphalt, and water-miscible liquids. For additional information, see NFPA 77, *Recommended Practice on Static Electricity*.

A.4.3.3.2.1 Dropping or rolling the tank into the hole can break a weld, puncture or damage the tank, or scrape off the protective coating of coated tanks. See PEI RP100, *Recommended Practices for Installation of Underground Liquid Storage Systems*.

A.4.3.4.1 Subsection 4.3.4 provides an approach that allows considerable flexibility for compliance without compromising fire safety, while fostering ingenuity in application of fire safety principles to achieve the intended objectives, outlined in the performance criteria set out at the beginning of each subsection. Each subsection has been written with the first sentence outlining the performance criteria that, if implemented, would achieve compliance with that subsection. In order to clarify the intent of each performance criterion, the subsequent paragraphs constitute one method of achieving compliance with the intent envisioned in the performance requirements. It is recognized that other combinations of requirements can also be used to meet the intent of the performance criteria, provided such requirements are acceptable to the authority having jurisdiction.

A.4.3.4.2.2(2) See NFPA 68, *Guide for Venting of Deflagrations*, for information on deflagration venting.

A.4.3.4.3.2 See NFPA 220, *Standard on Types of Building Construction*.

A.4.3.4.3.4 See NFPA 68, *Guide for Venting of Deflagrations*, for information on deflagration venting.

A.4.3.4.3.5 NFPA 101, *Life Safety Code*, provides information on the design of exit facilities.

A.4.3.4.4.2 Equipment in enclosed storage areas can deteriorate over time and periodic evaluation should be conducted to assure that leakage rates have not increased or that the ventilation rate is adequate for any increase in leakage rates.

A.4.3.4.4.4 Local or spot ventilation might be needed for the control of special fire or health hazards. NFPA 91, *Standard for Exhaust Systems for Air Conveying of Vapors, Gases, Mists, and Noncombustible Particulate Solids*, and NFPA 90A, *Standard for the Installation of Air-Conditioning and Ventilating Systems*, provide information on this subject.

A.4.3.4.5.5 Annex A of NFPA 15, *Standard for Water Spray Fixed Systems for Fire Protection*, provides information on this subject.

A.4.3.4.7.5 Substitutes for manual gauging include, but are not limited to, heavy-duty flat gauge glasses; magnetic, hydraulic, or hydrostatic remote reading devices; and sealed float

gauges.

A.4.3.4.7.8 Suitable devices include, but are not limited to, a float valve; a pre-set meter on the fill line; a low head pump incapable of producing overflow; or a liquidtight overflow pipe, sized at least one pipe size larger than the fill pipe, that discharges by gravity back to the outside source of liquid or to an approved location.

A.4.3.4.11.1 NFPA 10, *Standard for Portable Fire Extinguishers*, provides information on the suitability of various types of extinguishers.

A.4.3.4.11.2 See NFPA 13, *Standard for the Installation of Sprinkler Systems*, and NFPA 14, *Standard for the Installation of Standpipe and Hose Systems*.

A.4.3.4.12.2 See NFPA 24, *Standard for the Installation of Private Fire Service Mains and Their Appurtenances*, for information on this subject.

A.4.3.4.12.3 See NFPA 13, *Standard for the Installation of Sprinkler Systems*; NFPA 15, *Standard for Water Spray Fixed Systems for Fire Protection*; and NFPA 16, *Standard for the Installation of Foam-Water Sprinkler and Foam-Water Spray Systems*, for information on these subjects.

For certain fuel types, such as ketones, esters, and alcohols, the minimum required densities established in the listing criteria for foam discharge devices are often higher than the general densities specified for protection of flammable and combustible liquids. When determining the design criteria for extinguishing systems using foam, it is important to ensure that the listing criteria, which are typically based on empirical data from fire tests, are not overlooked. Otherwise, the fire protection system design can be inadequate for proper protection.

A.4.4.2 See PEI RP200, *Recommended Practices for Installation of Aboveground Storage Systems for Motor Vehicle Fueling*, and STI R931, *Double Wall AST Installation and Testing Instructions*, for additional requirements to test secondary containment tanks.

A.4.4.3 For information on testing of underground tanks, see NFPA 329, *Recommended Practice for Handling Releases of Flammable and Combustible Liquids and Gases*. For information on testing aboveground tanks, see API 653, *Tank Inspection, Repair, Alteration, and Reconstruction*.

A.4.5.3.3 See NFPA 51B, *Standard for Fire Prevention During Welding, Cutting, and Other Hot Work*.

A.4.5.3.4 The prevention of electrostatic ignition in equipment is a complex subject. Refer to NFPA 77, *Recommended Practice on Static Electricity*, or manufacturer's recommendations for guidance.

A.4.6.4.1 For further information, see API 2015, *Cleaning Petroleum Storage Tanks*; API 2015A, *A Guide for Controlling the Lead Hazard Associated with Tank Entry and Cleaning*; and API 2015B, *Cleaning Open Top and Covered Floating Roof Tanks*.

A.4.6.5.4(2) Special training might be required.

A.4.6.6 See NFPA 329, *Recommended Practice for Handling Releases of Flammable and*

Copyright NFPA

Combustible Liquids and Gases, for information on testing methods.

A.4.6.7.1 Regular inspections of aboveground storage tanks, performed in accordance with national standards, provide a means to ensure system maintenance. Acceptable standards include, but are not limited to, the following:

- (1) API 653, *Tank Inspection, Repair, Alteration, and Reconstruction*
- (2) STI SP001-01, *Standard for Inspection of In-Service Shop Fabricated Aboveground Tanks for Storage of Combustible and Flammable Liquids*
- (3) API 12R1, *Setting, Maintenance, Inspection, Operation, and Repair of Tanks in Production Service*
- (4) API 2350, *Overfill Protection for Storage Tanks in Petroleum Facilities*

A.4.6.7.4 For additional information, see API 653, *Tank Inspection, Repair, Alteration, and Reconstruction*.

A.5.5.2 API 2218, *Fireproofing Practices in Petroleum and Petrochemical Processing Plants*, contains guidance on selecting and installing fire-resistant coatings to protect exposed steel supports from a high-challenge fire exposure. It also contains a general discussion on determining need for such protection and estimating the extent of the area exposed.

A.5.5.4 Buried steel piping should be coated with a suitable material and should be cathodically protected. Galvanized steel pipe, by itself and without other corrosion protection methods, is not acceptable for underground piping. Steel swing joints and stainless steel flexible connectors should also be made corrosion resistant when in contact with the soil. Thus, such fittings should also be coated and cathodically protected when installed between nonmetallic, compatible tanks and piping, such as fiberglass reinforced plastic.

A.5.7.1.4 Vent sizing formulae and prescriptive vent sizes, such as those established by UL 142, *Standard for Steel Aboveground Tanks for Flammable and Combustible Liquids*, are typically based on the direct installation of a venting device onto a tank. When the outlet of a vent must be extended to a remote location, such as for tanks located in buildings, which require vent discharges, to be located outside, a significant reduction in vent flow can occur unless the size of the vent and connecting piping is increased. In such cases, the size of vents and vent pipe extensions should be calculated to ensure that a tank will not be over-pressurized during a fire exposure.

A.5.9 Where loading and unloading risers for Class II or Class IIIA liquids are located in the same immediate area as loading and unloading risers for Class I liquids, consideration should be given to providing positive means, such as different pipe sizes, connection devices, special locks, or other methods designed to prevent the erroneous transfer of Class I liquids into or from any container or tank used for Class II or Class IIIA liquids. Note that such consideration might not be necessary for water-miscible liquids, where the class is determined by the concentration of liquid in water, or where the equipment is cleaned between transfers.

A.6.2.1(5) The term *rigid nonmetallic intermediate bulk container* is used to describe intermediate bulk containers that have a plastic vessel that serves as the primary liquid-holding component. This vessel can be enclosed in or encased by an outer structure consisting of a steel cage, a single-wall metal or plastic enclosure, or a double wall of foamed or solid plastic. These are often called *composite IBCs*, which is the term used by U.S. Department of Transportation (DOT) to describe them. The term *rigid nonmetallic intermediate bulk container* also denotes an all-plastic single-wall IBC that could or could not have a separate plastic base and for which the containment vessel also serves as the support structure. IBCs that have an outer liquidtight metal structure are considered to be metal IBCs or metal portable tanks by DOT and are defined in 6.2.1(1).

A.6.3.4 Venting of storage cabinets has not been demonstrated to be necessary for fire protection purposes. Additionally, venting a cabinet could compromise the ability of the cabinet to adequately protect its contents from involvement in a fire because cabinets are not generally tested with any venting. Therefore, venting of storage cabinets is not recommended.

However, it is recognized that some jurisdictions can require storage cabinets to be vented and that venting can also be desirable for other reasons, such as health and safety. In such cases, the venting system should be installed so as to not affect substantially the desired performance of the cabinet during a fire. Means of accomplishing this can include thermally actuated dampers on the vent openings or sufficiently insulating the vent piping system to prevent the internal temperature of the cabinet from rising above that specified. Any make-up air to the cabinet should also be arranged in a similar manner.

If vented, the cabinet should be vented from the bottom with make-up air supplied to the top. Also, mechanical exhaust ventilation is preferred and should comply with NFPA 91, *Standard for Exhaust Systems for Air Conveying of Vapors, Gases, Mists, and Noncombustible Particulate Solids*. Manifolding the vents of multiple storage cabinets should be avoided.

A.6.4 See Chapter 3 for definitions. See Figure A.6.4(a) and Figure A.6.4(b) for explanatory information on the types of inside liquid storage areas. See Annex D and Annex E for information on protection criteria.

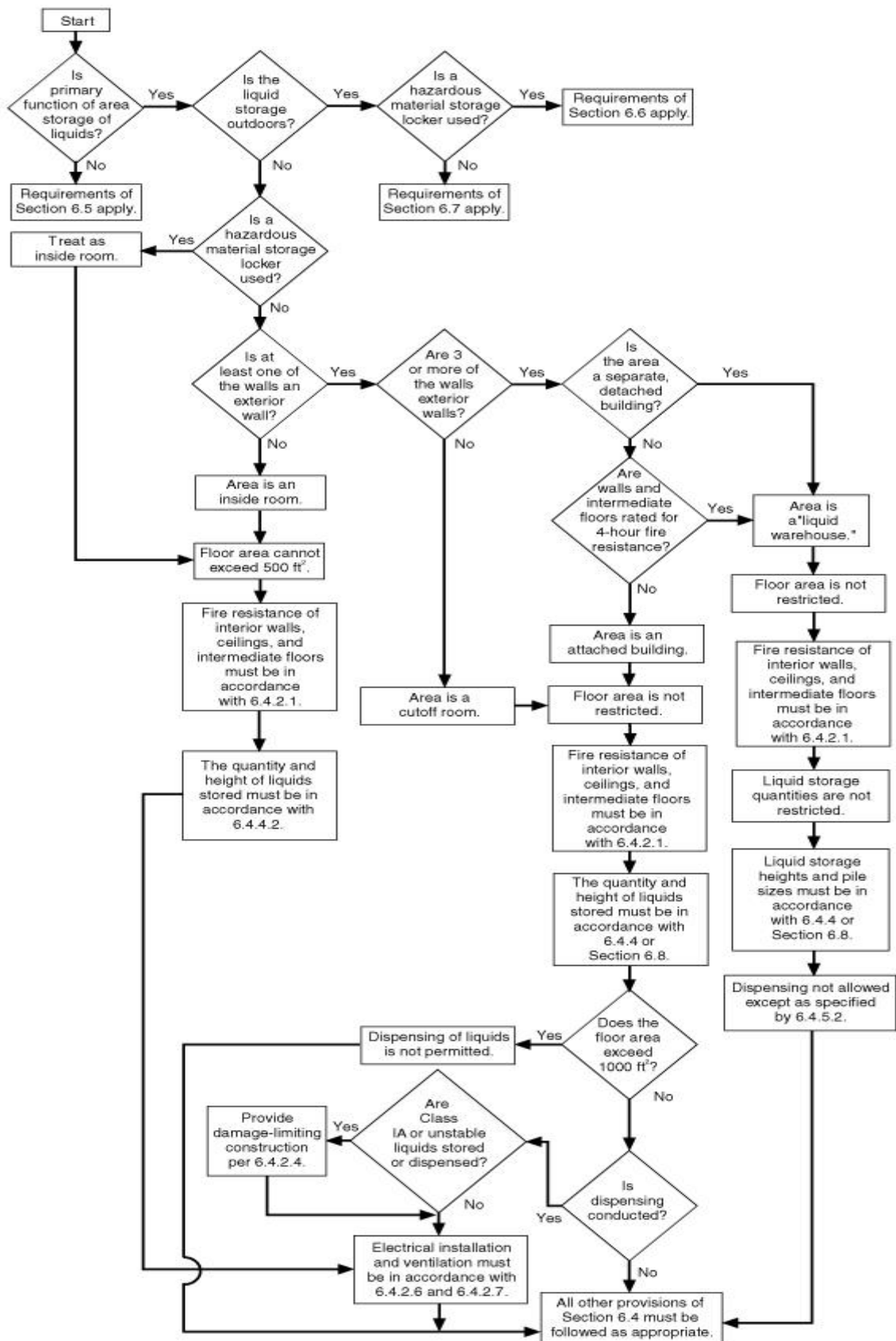

FIGURE A.6.4(a) Guide to Application of Chapter 6, Container and Portable Tank Storage.

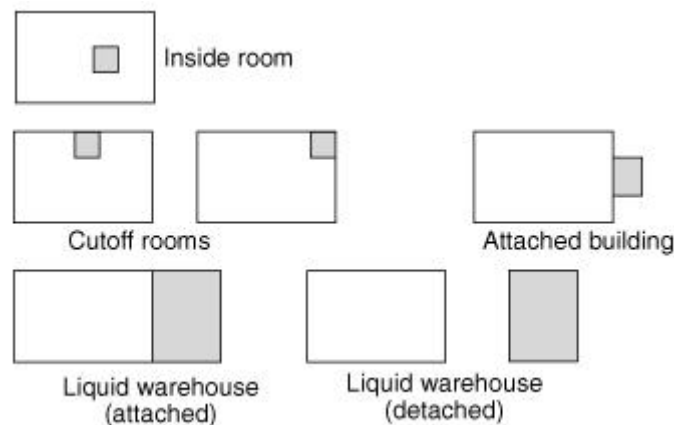

FIGURE A.6.4(b) Examples of the Various Inside Liquid Storage Areas. Shaded Areas are the Liquid Storage Areas.

A.6.4.2.4 Release of a Class IA liquid into a room or enclosure can result in the evolution of large quantities of flammable vapor. The ignition of this flammable mixture can result in a significant pressure rise, the production of hot combustion gases, and flame. Failure to adequately design a room or building for this type of event can result in the failure of the room/building walls and/or roof and the uncontrolled release of the hot combustion gases, flames, and pressure. An acceptable method of protection against this type of event is the use of damage-limiting construction consisting of a combination of pressure relieving and pressure-resistant construction as described in NFPA 68, *Guide for Venting of Deflagrations*, and other standards.

A.6.4.2.5 Spill containment can be accomplished by any of the following:

- (1) Noncombustible, liquidtight raised sills, curbs, or ramps of suitable height at exterior openings
- (2) Noncombustible, liquidtight raised sills, curbs, or ramps of suitable height, or other flow-diverting structures at interior openings
- (3) Sloped floors
- (4) Open-grate trenches or floor drains that are connected to a properly designed drainage system
- (5) Wall scuppers that discharge to a safe location or to a properly designed drainage system
- (6) Other means that are acceptable to the authority having jurisdiction

Where sills, curbs, or ramps are used, the appropriate height will depend on a number of factors, including the maximum expected spill volume, the floor area, and the existence of any drainage systems. Historically, curbs and sills have been 100 mm (4 in.) high.

A variety of curb, sill, and ramp heights can be used to obtain the desired containment volume. As a guide, 1 m² of water at a depth of 25 mm equals 25 L (1 ft² of water @ 1 in. depth = 0.62 gal). Once the total quantity of liquid containment has been established, the necessary curb, sill, or ramp height can then be calculated.

Where open-grate trenches are used, the volume of the trench should be able to contain the maximum expected spill volume or otherwise be connected to a properly designed drainage system.

It should be noted that these containment and drainage provisions address only fire protection concerns. Consult the appropriate environmental regulations for other restrictions that could apply. (*See 1.5.3.*)

A.6.4.4.1 The other arrangements referred to in the Exception include, but are not limited to, increases in pile height, pile size, or maximum total quantity stored, or use of multiple-row racks or high-rise warehouses.

A.6.5.2.4 Exception No. 2 is based on work done by FM Global, which showed that flammable liquids in plastic containers could cause uncontrollable fires under certain conditions of storage in general-purpose warehouses. A research project on flammable liquids container storage carried out by Underwriters Laboratories Inc., under the auspices of the National Fire Protection Research Foundation, has suggested a test protocol that can judge the capability of packaging systems to withstand a small ignition source or to minimize the rate at which the lading is released from the containers, so that the fire can be controlled by automatic sprinklers.

There is currently no nationally recognized consensus standard for conducting such tests.

A.6.6 Environmental concerns have dictated special handling of hazardous materials, chemicals, and wastes. Some of these have flammable and combustible liquid characteristics, in addition to their environmental and health problems, thus causing some questions as to how they should be stored and handled.

Several manufacturers have met this problem by designing and manufacturing movable, modular prefabricated storage lockers, working diligently with various building officials and authorities having jurisdiction. This results in a product that is intended to meet government standards and regulations for hazardous materials storage. Several municipalities have passed model ordinances covering the design, construction, and location of hazardous materials storage lockers. Design features can include, but are not limited to, the following:

- (1) Secondary spill containment sumps
- (2) Deflagration venting
- (3) Ventilation requirements, including mechanical ventilation where dispensing operations are expected
- (4) Electrical equipment for hazardous locations in accordance with NFPA 70, *National Electrical Code*
- (5) Static electricity control

- (6) Fire suppression systems (dry chemical or sprinklers)
- (7) Heavy structural design for the following:
 - (a) Security provisions
 - (b) Doors that lock and permit pallet loading
 - (c) Wind load, snow load, and storage load conditions
 - (d) Anchorage provisions
 - (e) Skid design, permitting relocation using lift trucks
- (8) Fire-rated exterior walls, if required
- (9) Interior partitions to segregate incompatible materials
- (10) Size limits to limit quantities that can be stored within preassembled or ready-to-assemble designs
- (11) Nonsparking floors
- (12) Shelving, if required
- (13) Heating or cooling units, if needed
- (14) Corrosion protection as required
- (15) Employee safety provisions (eye/face wash)
- (16) NFPA 704, *Standard System for the Identification of the Hazards of Materials for Emergency Response*, hazard symbols

Features provided are determined by specific storage requirements and needs of the owner, keeping in mind applicable regulations and ordinances that apply and the approval requirements of the authority having jurisdiction.

Several testing laboratories have developed internal procedures for the examination, testing, and listing or labeling of hazardous materials storage lockers submitted by manufacturers.

A.6.8 See Annex E for limitations of the protection criteria of Table 6.8.2(a) through Table 6.8.2(k), particularly for intermediate bulk containers and portable tanks having capacities greater than 230 L (60 gal).

A.6.8.1.3 Table A.6.8.1.3 provides examples of commonly used metal containers that are considered either relieving style or nonrelieving style for use in developing protected storage arrangements in accordance with Table 6.8.2(a) through Table 6.8.2(d) and Table 6.8.2(h).

Table A.6.8.1.3 Common Relieving- and Nonrelieving-Style Metal Containers

Container Type	Relieving Style	Nonrelieving Style
≤ 1 qt ¹	All	N/A
>1 qt and ≤ 6 gal ¹	Metal containers with plastic cap, or flexible or rigid plastic spout with plastic cap	Metal containers with steel spout and steel screw cap

Table A.6.8.1.3 Common Relieving- and Nonrelieving-Style Metal Containers

Container Type	Relieving Style	Nonrelieving Style
≤ 1 gal, friction lid	Metal containers with metal friction-fit covers (e.g., paint can lid)	N/A
1 gal and ≤ 6 gal (lug cover)	Metal containers with metal covers held in place with a mechanical friction-fit (e.g., lug-type) closure mechanism	N/A
>6 gal and ≤ 60 gal ^{2,3} (drums)	Metal containers, tight or open-head (drums) having at least one 2 in. plastic plug: (Note: cap seals, if used, need to be plastic and nonmetallic)	Open head metal containers with steel covers having no steel flange openings; or open head and tight head metal containers with steel flange openings where only steel plugs and/or cap seals are used
>60 gal and ≤ 793 gal	Metal portable tanks or metal intermediate bulk containers with at least one relief device conforming to the design, construction, and capacity of the container's section (see Section 6.2)	N/A

Note: For SI units, 1 gal = 3.8 L.

¹All containers ≤ 1 qt are considered relieving style because their failure is inconsequential.

²In full-scale fire tests, where containers were provided with both 19 mm (¾ in.) and 50 mm (2 in.) relieving vent openings and, in some cases, both vents were obstructed by pallet slats, rupture of containers did not occur. Because it is not possible to determine if all conceivable obstruction scenarios were represented, where drums are stacked more than one high, provide an additional 19 mm (¾ in.) or 50 mm (2 in.) pressure-relieving mechanism.

³The use of plastic plugs instead of steel plugs (bungs) in a steel drum in order to achieve a relieving-style container should contemplate the following issues in order to assure the safe storage of liquids:

- (1) The compatibility of the plastic plug materials and gaskets with the liquids being stored.
- (2) The stability and shelf life of the liquids being stored as the plastic plugs can admit water vapor, oxygen, and light.
- (3) The difference in expansion coefficients for plastic plugs and steel drums for those drums subject to temperature variations and hot or cold conditions.
- (4) The tooling issues involved with the use of plastic plugs as the torque levels are different from those levels used for steel plugs.
- (5) The training of fill line operators in order to avoid cross-threading and/or the stripping of threads.
- (6) The voiding of the United Nations (UN) rating on the steel drum by installing plastic plugs. If the user needs to install a plug other than the one originally provided by the container manufacturer, then the user should contact the manufacturer to ensure that the UN rating will still be valid.

A.6.8.1.6 Interpolation between 6.8.1.6(1) and 6.8.1.6(2) is allowed.

A.6.8.1.7 Unsaturated polyester resins (UPRs) are high molecular weight unsaturated polymers dissolved in a reactive monomer, usually styrene, in concentrations of 50 percent or less by weight. UPRs are combined with reinforcements such as fiberglass and/or fillers to produce a wide range of products. Examples of such products include automobile parts, bathroom tubs and shower stalls, cultured marble, and many products for architectural,

recreational, construction, and corrosion-resistant applications. UPRs are normally packaged in 208 L (55 gal) drums. The U. S. Department of Transportation classification for UPRs is “UN 1866, Resin Solution”; however, it should be noted that this classification includes many materials that are not unsaturated polyester resins.

A.6.8.2 Protected storage allowed under previous editions of this code can be continued if the class of liquids stored, the quantity of liquids stored, fire protection, and building configuration remain unchanged. Table A.6.8.2(a) and Table A.6.8.2(b), reprinted here from the 1993 edition of this code, can be used as a reference for storage arrangements in previously approved, protected, inside liquid storage areas.

For certain liquids such as ketones, esters, and alcohols, the minimum required densities established in the listing criteria for foam discharge devices are often higher than the general densities specified for protection of flammable and combustible liquids. When determining the design criteria for extinguishing systems using foam, it is important to ensure that the listing criteria, which are typically based on empirical data from fire tests, are not overlooked. Otherwise, the fire protection system design can be inadequate for proper protection.

ESFR sprinklers have been tested for protection of liquids only to the extent reflected in the tables in Section 6.8. Any other use of ESFR sprinklers for protection of liquids should be based on an engineering analysis that evaluates the potential failure of the sprinkler system based on a rapid growth fire or a large pool fire that would operate more sprinklers than are accommodated by the design area. The use of ESFR protection, particularly without provisions for the control of spread of liquid, presents the possibility of a liquid pool fire that could exceed the limited design operating area of an ESFR system.

The information in Table 6.8.2(a) through Table 6.8.2(k) was developed from full-scale fire tests. Where only one K-factor sprinkler is allowed, this was the only size proven to provide fire control. Where a choice of K-factors is allowed by the tables, each was able to provide fire control; however, the larger K-factor sprinklers sometimes demonstrated better fire control and further limited fire damage. Where only one response type of sprinkler is allowed, this is the only type of sprinkler proven to provide fire control. Where a choice of response characteristics (SR or QR) is allowed by the tables, each was able to provide fire control; however, the QR sprinklers sometimes demonstrated better fire control and further limited fire damage.

Table A.6.8.2(a) Storage Arrangements for Protected Palletized or Solid Pile Storage of

Liquid Class	Storage Level	Maximum Storage Height (ft)		Maxin Quantity pe
		Containers	Portable Tanks	Containers
IA	Ground floor	5	—	3,000
	Upper floors	5	—	2,000
	Basement	NP	NP	—
IB	Ground floor	6½	7	5,000
	Upper floors	6½	7	3,000

Table A.6.8.2(a) Storage Arrangements for Protected Palletized or Solid Pile Storage of

Liquid Class	Storage Level	Maximum Storage Height (ft)		Maximum Quantity per
		Containers	Portable Tanks	Containers
IC	Basement	NP	NP	—
	Ground floor	6½ ^b	7	5,000
	Upper floors	6½ ^b	7	3,000
II	Basement	NP	NP	—
	Ground floor	10	14	10,000
	Upper floors	10	14	10,000
III	Basement	5	7	7,500
	Ground floor	20	14	15,000
	Upper floors	20	14	15,000
	Basement	10	7	10,000

Notes:

(1) For SI units, 1 ft = 0.3 m; 1 gal = 3.8 L.

(2) NP = not permitted.

^aApplies only to cut-off rooms and attached buildings.

^bThese height limitations can be increased to 10 ft for containers of 5 gal capacity or less.

Table A.6.8.2(b) Storage Arrangements for Protected Rack Storage

Liquid Class	Type Rack	Storage Level
IA	Double row	Ground floor
	or	Upper floors
	single row	Basement
IB	Double row	Ground floor
	or	Upper floors
	single row	Basement
II	Double row	Ground floor
	or	Upper floors
	single row	Basement
III	Multirow,	Ground floor
	double row,	Upper floors
	or single row	Basement

Notes:

(1) For SI units, 1 ft = 0.3 m; 1 gal = 3.8 L.

(2) NP = not permitted.

^aMaximum quantity allowed on racks in cut-off rooms and attached buildings.

^bMaximum quantity allowed per rack section in liquid warehouses.

A.6.8.2.8 Most fire tests using foam-water protection schemes have been conducted with immediate foam solution discharge from the operating sprinklers. If an appreciable delay is encountered before properly proportioned foam is discharged, control of the fire might not be established. One method of accomplishing immediate foam solution discharge is by using an in-line balanced pressure (ILBP) proportioning system.

A.6.8.5.1 Paragraph 6.8.5.1 requires that control of liquid spread be provided to prevent a pool fire on the floor from spreading and opening more sprinkler heads than the design of the sprinkler system anticipates. For example, if the sprinkler system is designed to provide 18 mm/min over 280 m² (0.45 gpm/ft² over 3000 ft²), 6.8.5.1 requires that the spread of liquid also be limited to 280 m² (3000 ft²). Various means are available to achieve this control.

Typical methods use trench or spot drains that divide the floor of the storage area into rectangles having areas equal to or less than the design area of the sprinkler system. Drains are centered under racks, and the floor is sloped toward the drain trenches with a minimum slope of 1 percent. The floor is made highest at the walls. See Figure A.6.8.5.1(a) and Figure A.6.8.5.1(b). Trenches are arranged as described in NFPA 15, *Standard for Water Spray Fixed Systems for Fire Protection*, and as shown in Figure A.6.8.5.1(c). Note particularly the dimensions of the trenches, and note that the solid covering spans one-third of the width on either side of the open grate and the open grate spans the middle third. Spot drains can be similarly arranged.

Another method, shown in Figure A.6.8.5.1(d), uses spot drains located at building columns, where the area between any four columns does not exceed the design area of the sprinkler system. The floor is sloped to direct water flow to the drains.

Connections to the drains are provided at trapped sumps, arranged as described in NFPA 15 [see Figure A.6.8.5.1(e)]. To provide a safety factor, the drain pipes are sometimes sized to carry 150 percent of anticipated sprinkler discharge. The following equation can be used to calculate the flow of the drain pipe:

$$F = 1.5DA$$

where:

F = flow (gpm or L/min)

D = sprinkler design density (gpm/ft² or L/min/m²)

A = sprinkler design area (ft² or m²)

Additional information can be found in *Guidelines for Safe Warehousing of Chemicals*, Center for Chemical Process Safety, American Institute of Chemical Engineers.

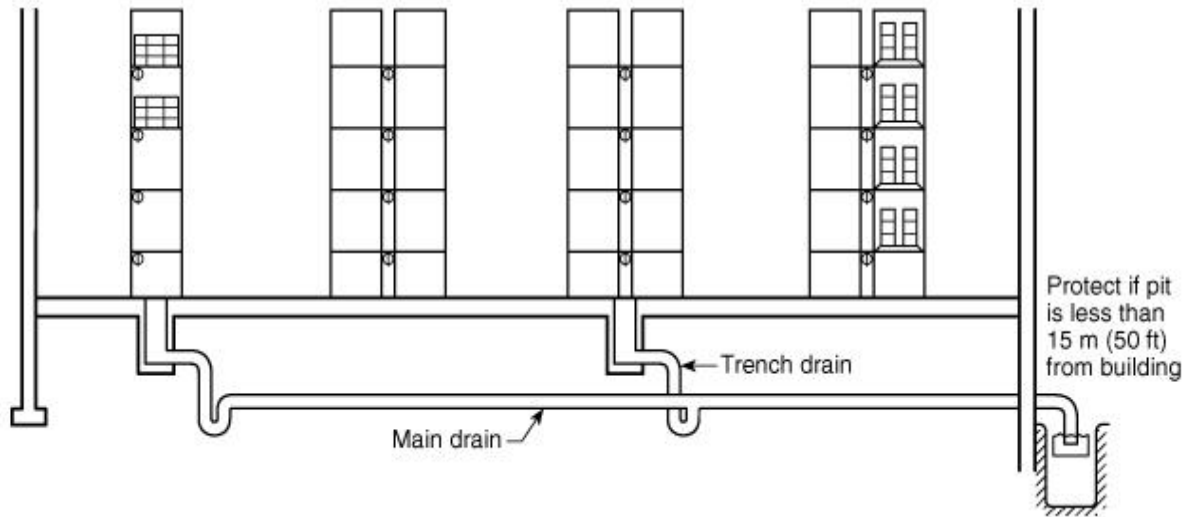

FIGURE A.6.8.5.1(a) General Scheme for Warehouse Spill Control of Liquids.

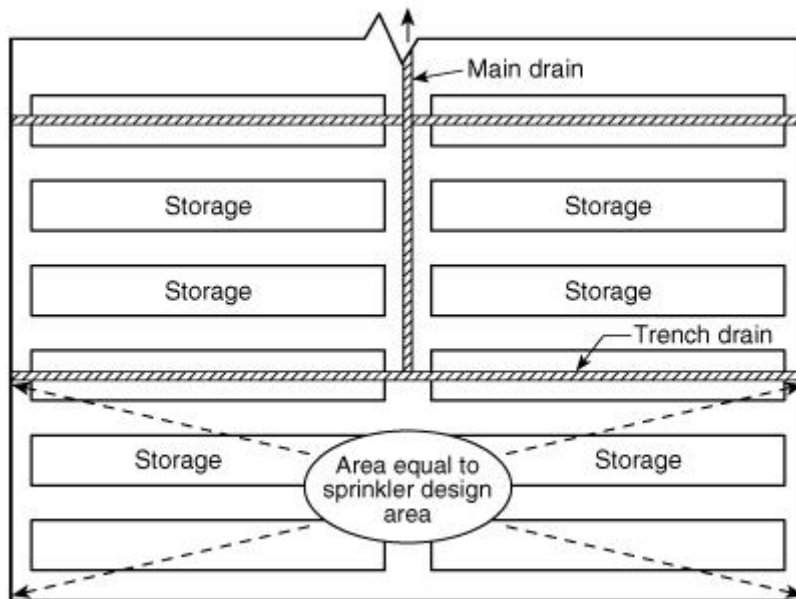

FIGURE A.6.8.5.1(b) Plan View of Warehouse Spill Control of Liquids.

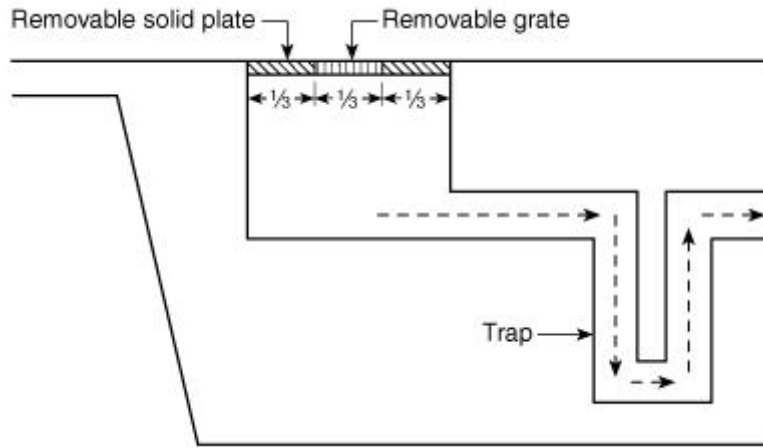

FIGURE A.6.8.5.1(c) Details of Drainage Trench Design.

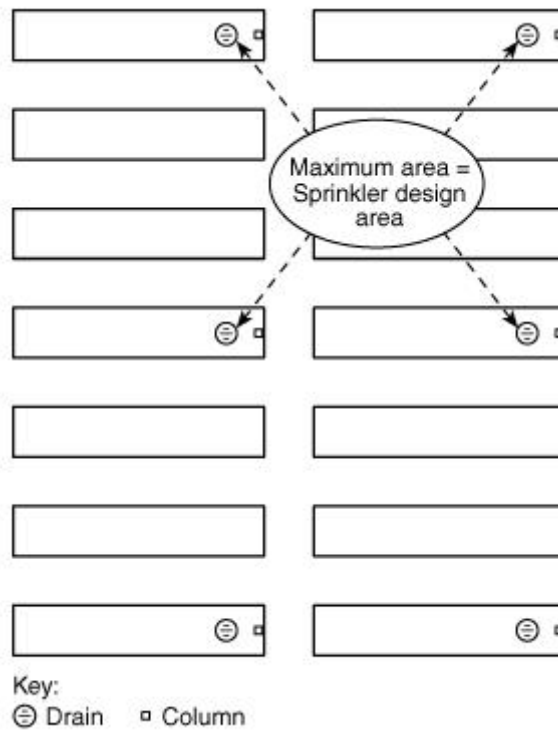

FIGURE A.6.8.5.1(d) Typical Arrangement of Floor Drains.

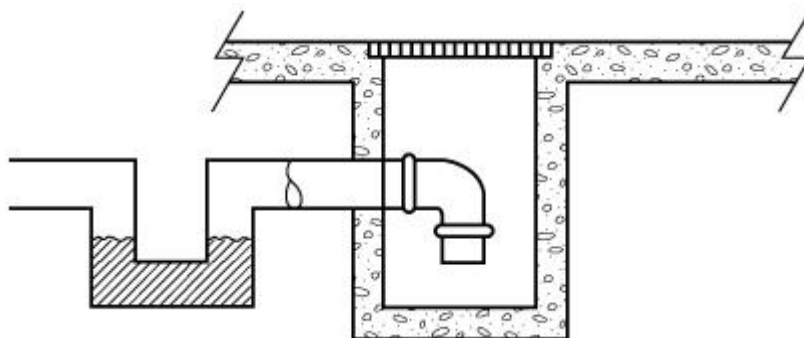

FIGURE A.6.8.5.1(e) Details of Liquid-Seal Trap.

A.6.10.1 The indiscriminate mixed storage of materials that have a high toxicity or high reactivity hazard that are also flammable liquids is a practice that could result in either a catastrophic release of toxic materials or an explosion. (See also Section 1.2 and A.1.2.)

A.6.10.2 Paragraph 4.2.3.2 of NFPA 505, *Fire Safety Standard for Powered Industrial Trucks Including Type Designations, Areas of Use, Conversions, Maintenance, and Operation*, states “In locations used for the storage of flammable liquids in sealed containers or liquefied or compressed flammable gases in containers, approved power-operated industrial trucks designated as Types CNS, DS, ES, GS, LPS, GS/CNS, or GS/LPS shall be permitted to be used where approved by the authority having jurisdiction.” Compared to the above types, industrial trucks that are designated DY and EE have significantly less potential for igniting flammable vapors (such as might result from a spill of Class I liquid) and should be used in inside liquid storage areas where conditions warrant.

A.7.1.2 These provisions might not provide adequate protection for operations involving hazardous materials or chemical reactions, nor do they consider health hazards resulting from exposure to such materials.

A.7.3.2.3 Equipment operated at pressures over 70 bar gauge (1000 psig or a gauge pressure of 7000 kPa) could require greater spacing.

A.7.3.3.1 See NFPA 220, *Standard on Types of Building Construction*.

A.7.3.3.2 API 2218, *Fireproofing Practices in Petroleum and Petrochemical Processing Plants*, contains guidance on selecting and installing fire-resistant coatings to protect exposed steel supports from a high-challenge fire exposure. It also contains a general discussion on determining need for such protection and estimating the extent of the area exposed.

A.7.3.3.4 NFPA 204, *Standard for Smoke and Heat Venting*, provides information on this subject.

A.7.3.3.5 NFPA 101, *Life Safety Code*, provides information on the design of exit facilities.

A.7.3.3.7 NFPA 68, *Guide for Venting of Deflagrations*, provides information on this subject.

A.7.3.4.2 Equipment in enclosed processing areas can deteriorate over time, and periodic

evaluation should be conducted to ensure that leakage rates have not increased or that the ventilation rate is adequate for any increase in leakage rates.

A.7.3.4.4 NFPA 91, *Standard for Exhaust Systems for Air Conveying of Vapors, Gases, Mists, and Noncombustible Particulate Solids*, and NFPA 90A, *Standard for the Installation of Air-Conditioning and Ventilating Systems*, provide information on this subject.

A.7.3.5.1 This might require curbs, scuppers, or special drainage systems to control the spread of fire. Annex A of NFPA 15, *Standard for Water Spray Fixed Systems for Fire Protection*, provides information on this subject.

A.7.3.7.8 The process area is not intended to be a liquid container storage area. However, it is recognized that containers of liquids are brought into the area to use in the processes and, that as a result of the processes, liquids could be filled into containers in the process area.

The amount of liquid in containers in the process area should be limited as much as possible. Full containers should not be stored in the process area but can be staged there. Only the amount of liquid needed for one continuous 24-hour period should be brought into the process area in full containers. Partial containers can remain in the process area as long as they do not increase the hazard present. Containers that were filled in the process area can remain there during the shift that they were filled but should be relocated to the appropriate storage area before the end of the workday or shift in the case of 24-hour-a-day operations.

A.7.3.8 Where the vapor space of equipment is usually within the flammable range, the probability of explosion damage to the equipment can be limited by inerting, by providing an explosion suppression system, or by designing the equipment to contain the peak explosion pressure that can be modified by explosion relief. Where the special hazards of operation, sources of ignition, or exposures indicate a need, consideration should be given to providing protection by one or more of the above means.

See NFPA 68, *Guide for Venting of Deflagrations*, and NFPA 69, *Standard on Explosion Prevention Systems*, for additional information on various methods of mitigating losses from explosions.

A.7.4.2 Mist explosions have occurred when heat transfer fluid that is above its boiling point has been released in an enclosed area. Consideration should be given to locating heaters or vaporizers either in a detached building or in a room with damage-limiting construction.

A.7.4.3 The system should be interlocked to stop circulation of the heat transfer fluid through the system and to shut off the system heater or vaporizer in the event of a fire, abnormally low pressure in the system, or operation of an approved heat detection system. Where the refractory inside the heater or vaporizer can retain enough heat to cause either breakdown of the heat transfer fluid or tube fouling if fluid circulation through the unit is stopped, circulation could have to be continued. In the event of a confirmed fire, it is desirable to subdivide the piping system by means of interlocked safety shutoff valves. A practical way of accomplishing this is to isolate all secondary-circulating loops from the primary loop that runs into and out of the vaporizer or heater.

A well-marked remote emergency shutoff switch or electrical disconnect should be provided

to shut down the entire system in the event of an emergency. This should be located either in a constantly attended location or at a location that would be accessible in the event of a leak or a fire.

If there are any process or utility lines running in or through rooms or areas containing parts of the heat transfer system, consideration should be given to providing emergency shutoff valves. They should be located so they are readily accessible in the event of a fire.

Where the liquid level in the system expansion tank is maintained by an automatically actuated supply pump taking suction from the heat transfer fluid storage tank, an interlock should be provided to shut down the supply pump when a high level indicator is actuated, regardless of whether the pump is in automatic or manual mode.

A.7.4.3.1 Heat transfer fluid systems have the potential for releasing large quantities of heated flammable or combustible liquid. Low point drains piped to a safe location provide the ability to remove heat transfer fluid from a breached piping system in order to minimize the total quantity of fluid released. An engineering analysis should be used to determine the location and design of low point drains. The engineering analysis should consider system inventory, the amount of heat transfer fluid that can be released in a specific fire area, the exposure created by a release, and the fire protection provided.

A.7.4.3.2 Where possible, the storage tank(s) should be located below the lowest system drain opening to permit gravity flow. Breather vents should be provided based on the maximum emptying or filling rates.

A.7.4.4 If stack gas from a heater or vaporizer is recovered to provide auxiliary heat for other equipment (e.g., rotary dryers), suitable dampers, isolation gates, burner control logic, or other means should be provided to ensure that all equipment is properly purged and will operate in a safe manner. The control logic should anticipate all possible operating modes of the individual pieces of equipment, whether operating singly or together, to ensure safe startup and shutdown under normal or upset conditions.

Instrumentation and interlocks should be provided to sound an alarm and to automatically shut down the fuel source to the heater or vaporizer when any of the following conditions are detected:

- (1) Low flow of heat transfer fluid through the heat exchange tubes of the heater, as measured at the discharge.
- (2) High temperature or pressure of the fluid at the heater or vaporizer outlet. The high-temperature interlock should be set at or below the manufacturer's maximum recommended bulk fluid temperature.
- (3) Low pressure at the heater or vaporizer outlet or elsewhere in the system. This interlock could require a bypass to allow for startup.
- (4) Low fluid level in the expansion tank.
- (5) Low liquid level in the vaporizer.
- (6) Sprinkler system flow in any area containing the heat transfer equipment or piping.

Alarm set points should be provided at levels below or above the automatic shutoff setpoints to monitor the above-mentioned variables and provide an opportunity for operators to correct the problem before conditions reach an unsafe level.

A.7.4.5.1 Where possible, piping should be run underground, outside, or in floor trenches. Overhead routing of heat transfer fluid piping should be minimized.

A.7.4.6.1 Historical records show that fires involving heat transfer fluids can be very severe and long lasting. It is recommended that automatic sprinkler or deluge protection be provided throughout all building areas potentially exposed to a heat transfer fluid spill fire.

A.7.4.7.1 Some factors that should be considered as part of such a review include the following:

- (1) *Infiltration of material being heated into the heat transfer system.* In this case, the system should be shut down and the internal leak point found and repaired as soon as possible.
- (2) *Leaks in the system.* Any leak should be corrected promptly regardless of how small. Corrections should be permanent, such as repacking valve stems and replacing leaky gaskets. Any heat transfer fluid released as a result of a leak or operation of a safety valve should be cleaned up immediately if it is or can come in contact with a hot surface. Other spills can be cleaned up at the first available opportunity.
- (3) *Pipe or equipment insulation that is soaked with heat transfer fluid.* In this case, the cause of the leak should be corrected promptly and the insulation replaced with clean, dry insulation.
- (4) *High temperature anywhere in the system.* In this case, operating procedures should specify shutdown of the heater or vaporizer fuel supply as soon as the temperature of the heat transfer fluid exceeds the manufacturer's recommended maximum bulk fluid temperature. Any corrective actions taken to correct a high temperature condition should only be done with the heat source shut off.

A.7.5.1 Incidental operations are operations that utilize liquids only as a limited activity to that which establishes the occupancy classification. Examples include automobile assembly, assembly of electronic equipment, furniture manufacturing, and areas within refineries, distilleries, and chemical plants where the use of liquids is incidental, such as in maintenance shops, office equipment, or vehicle repair shops. Some more detailed descriptions follow:

- (1) *Vehicle Assembly.* Vehicle assembly operations usually involve both process and incidental use of liquids. An example of a process operation would be paint storage and mixing utilized for application of the vehicle primer, color coats, and clear coats. For these operations, the requirements of Section 7.3 apply. Examples of incidental use would be sealer deck wipedown operations, windshield washer solvent dispensing, brake fluid filling, and final line paint repair operations. These operations might be continuous. However, the quantities of liquids used and the vapor exposures are significantly reduced from larger volume usage found within vehicle body component paint mixing and storage operations.

- (2) *Assembly of Electrical Equipment.* Examples of incidental use of liquids in these types of occupancies might include “photoresist” coating operations, “softbaking” operations, wave solder operations, and wipedown operations.
- (3) *Chemical Plant Maintenance Shop.* Incidental use of liquids is commonplace in maintenance shops located within a chemical plant. Examples are cutting oils used in a machine shop, Class II solvents for degreasing, and Class I and II paint solvents and fuels associated with automotive and industrial truck repair.
- (4) *Cleaning and Sanitation.* Under provisions established by the U.S. Food and Drug Administration (FDA) in 21 CFR, “GMP for Medical Devices,” Class I and Class II liquids can be used for cleaning and sanitation purposes. Limited quantities are used to remove manufacturing materials, mold release compounds, and other contaminants not intended to be on the final product. An example would be the use of isopropyl alcohol (IPA), transferred to a cleaning wipe via a plunger-type liquid-dispensing container. The cleaning wipe is then used to remove manufacturing materials not intended to be on the final product. The key point here is not that the liquid is not part of the final product, but that limited quantities of liquid are used and the use is incidental to the manufacturing operation that produces the product.

A.7.5.5(3) NFPA 91, *Standard for Exhaust Systems for Air Conveying of Vapors, Gases, Mists, and Noncombustible Particulate Solids*, provides information on the design and installation of mechanical ventilation.

A.7.6.3 Use of fixed fire protection systems, dikes, fire-rated barriers, or a combination of any of these can provide suitable protection from exposures.

A.7.6.4 The intent of this requirement is to prevent the spread of uncontrolled, spilled liquid from traveling beyond the loading or unloading area and exposing surrounding equipment and buildings.

A.7.6.6 The use of nonconductive materials in the fill pipe assembly should be avoided to prevent any electrical discontinuity in the piping of the system. Serious accidents have occurred when nonconductive materials, such as plastic or rubber hose, have been used in the fill pipe assembly.

A.7.6.10.4 NFPA 77, *Recommended Practice on Static Electricity*, provides additional information on protection against static electricity.

A.7.6.11.2 NFPA 77, *Recommended Practice on Static Electricity*, provides additional information on static electricity protection.

A.7.6.12 The term *switch loading* describes a situation that warrants special consideration.

When a tank is emptied of a cargo of Class I liquid, a mixture of vapor and air is left, which can be, and often is, within the flammable range. When such a tank is refilled with a Class I liquid, any charge that reaches the tank shell will be bled off by the required bond wire. Also, there will be no flammable mixture at the surface of the rising oil level because the Class I liquid produces at its surface a mixture too rich to be ignitable. This is the situation commonly existing in tank vehicles in gasoline service. If, as occasionally happens, a static

charge does accumulate on the surface sufficient to produce a spark, it occurs in a too-rich, nonignitable atmosphere and thus causes no harm.

A very different situation arises if the liquid is “switch loaded,” that is, when a Class II or Class III liquid is loaded into a tank vehicle that previously contained a Class I liquid.

Class II or Class III liquids are not necessarily more potent static generators than the Class I liquid previously loaded, but the atmosphere in contact with the rising oil surface is not enriched to bring it out of the flammable range. If circumstances are such that a spark should occur either across the oil surface or from the oil surface to some other object, the spark occurs in a mixture that can be within the flammable range, and an explosion can result.

It is emphasized that bonding the tank to the fill stem is not sufficient; a majority of the recorded explosions have occurred when it was believed the tank had been adequately bonded. The electrostatic potential that is responsible for the spark exists inside the tank on the surface of the liquid and cannot be removed by bonding. Measures to reduce the change of such internal static ignition can be one or more of the following:

- (1) Avoid spark promoters. Conductive objects floating on the oil surface increase the charge of sparking to the tank wall. Metal gauge rods or other objects projecting into the vapor space can create a spark gap as the rising liquid level approaches the projection. A common precaution is to require that fill pipes (downspouts) reach as close to the bottom of the tank as practicable. Any operation such as sampling, taking oil temperature, or gauging that involves lowering a conductive object through an opening into the vapor space on the oil should be deferred until at least 1 minute after flow has ceased. This will permit any surface charge to relax.
- (2) Reduce the static generation by one or more of the following:
 - (a) Avoid splash filling and upward spraying of oil where bottom filling is used.
 - (b) Employ reduced fill rates at the start of filling through downspouts, until the end of the spout is submerged. Some consider 0.9 m/sec (3 ft/sec) to be a suitable precaution.
 - (c) Where filters are employed, provide relaxation time in the piping downstream from the filters. A relaxation time of 30 seconds is considered by some to be a suitable precaution.
- (3) Eliminate the flammable mixture before switch loadings by gas freeing or inerting.

See NFPA 77, *Recommended Practice on Static Electricity*, and NFPA 385, *Standard for Tank Vehicles for Flammable and Combustible Liquids*, for further information.

A.7.7.19 Where practical, the collection basin should be drained to a remote location.

A.7.7.21 Because of the many variables involved, exact requirements cannot be provided. However, Table A.7.7.21 provides guidance on the level of fire protection typically provided at wharves and marine terminals handling flammable liquids.

Table A.7.7.21 Typical Fire Protection for Wharves and Marine Terminals

A.7.7.19 Where practical, the collection basin should be drained to a remote location.

A.7.7.21 Because of the many variables involved, exact requirements cannot be provided. However, Table A.7.7.21 provides guidance on the level of fire protection typically provided at wharves and marine terminals handling flammable liquids.

Table A.7.7.21 Typical Fire Protection for Wharves and Marine Terminals

Locations	Water Demand (gpm)	Hydrant Monitors ^a (gpm)	Hose Reels	Fire Extinguisher Dry Chemical		International Shore Connection
				30 lb	150 lb Wheeled	
Barge terminals	500–1000	Two 500	Two 1¼	2	NR	NR
Tankers 20,000 DWT and under	1000–2000	Two 500	Two 1¼	2	1	1
20,001–70,000 DWT	2000	Two 1000	Four 1¼ ^c	2	2 ^d	2
70,001 DWT and over	2000 ^e	Two 1000	Four 1¼ ^c	3	2 ^d	2
Sea islands	2000–4000 ^e	Three 1000	Four 1¼ ^c	4	2	3

Notes:

(1) For SI units, 1 gpm = 3.8 L/min; 1 gal = 3.8 L; 1 lb = 0.45 kg.

(2) NR = not required.

^aA minimum of two 38 mm (1½ in.) hydrant outlets should be provided at each monitor riser.

^bCan be provided by onshore mobile equipment.

^cOne hose reel at each berth should have foam capability.

^dThe proximity of adjacent berths can reduce total required.

^eUnder-dock systems are optional. Add water for under-dock system (0.16 × area).

^fUnder-dock systems are optional. Add foam for under-dock system (0.16 × 0.3 × 30 × area).

A.7.9.3 See NFPA 51B, *Standard for Fire Prevention During Welding, Cutting, and Other Hot Work*.

A.7.9.4 The prevention of electrostatic ignition in equipment is a complex subject. Refer to NFPA 77, *Recommended Practice on Static Electricity*, for guidance.

A.7.10.5 If the liquid knock-out vessel utilizes a pump for automatic liquid removal, consideration should be given to a low-level alarm and shutdown to avoid running the pump dry, resulting in a potential source of ignition.

A.7.10.7.2 Electrical enclosures that need to be opened frequently for maintenance (i.e., enclosures housing vapor processing system controls) have a higher potential for mechanical damage that could render the enclosures unable to contain an explosion. Additional inspection could be needed to ensure the integrity of the enclosure.

A.7.10.7.3 The most recent edition of API 2003, *Protection Against Ignition Arising Out of*
Copyright NFPA

Static, Lightning, and Stray Currents, can be used as a reference for protections against static ignition.

A.7.10.7.4 Spontaneous ignition can be a problem in the following:

- (1) Facilities where pyrophoric deposits can accumulate from the handling of oxygen-deficient vapors containing sulfur compounds or asphaltic materials. When air is introduced into the system, the pyrophoric materials can react, resulting in potential ignition and fire.
- (2) Facilities that handle fluids in such a way that mixing of hypergolic or otherwise incompatible materials can occur. Such mixing could occur with fluids remaining in the vapor recovery system from prior loading activities.
- (3) Facilities handling oxygenated hydrocarbons in carbon absorption units. Higher heats of absorption for these types of vapors can potentially lead to overheated carbon beds and increase the chance that an oxidation reaction can be initiated. *(For further information, refer to API Report, "An Engineering Analysis of the Effects of Oxygenated Fuels on Marketing Vapor Recovery Equipment.")*

A.7.10.7.5 Department of Transportation Coast Guard Regulation of the 33 CFR 154, Section 154.826(b), (c), and (d) can be used as a reference for vapor mover designs that minimize the potential for ignition.

A.7.10.7.6 The potential for ignition in the vapor collection system needs to be evaluated on a case-by-case basis.

If ignition occurs, flame propagation in piping systems containing vapor mixtures in the flammable range normally starts with low-speed burning (deflagration). As the flame moves through the piping, it accelerates and, within a short distance, can reach supersonic speeds (detonation). Initial low-speed flame propagation can be stopped by flame arrestors, liquid seals, or automatic fast-acting valve systems where designed, operated, and tested within the requirements of NFPA 69, *Standard on Explosion Prevention Systems*. Flame propagation can also be stopped for both deflagrations and detonations by use of detonation arrestors tested in accordance with U.S. Department of Transportation Coast Guard Regulations of the 33 CFR 154, Appendix A, or other procedures acceptable to the authority having jurisdiction, or automatic fast-acting valve systems tested under the appropriate conditions.

A.7.13.1.1 Other recognized fire prevention and control factors, involving construction, location, and separation, are addressed elsewhere in this chapter.

A.7.13.1.2 The wide range in size, design, and location of liquid-processing facilities precludes the inclusion of detailed fire prevention and control systems and methods applicable to all such facilities.

A.7.13.2.1 NFPA 10, *Standard for Portable Fire Extinguishers*, provides information on the suitability of various types of extinguishers.

A.7.13.3.2 Permanent connections to process water lines from the fire water system present an opportunity for contamination of the fire water with process fluids. Incidents have occurred where fire water was contaminated with flammable process liquids, with

subsequent increased fire damage and, in some cases, injury. Temporary connections are permitted to meet extraordinary needs, as in turnaround and inspection periods, tank cleaning, etc. However, care should be taken to address the potential for contamination. Where such use occurs frequently enough to justify a more robust arrangement, double block-and-bleed valves, removable spool pieces, or other means should be used to assure that no contamination can occur. Check valves alone are not sufficient.

Use of utility water sources, such as boiler feedwater, which are not contaminated, is acceptable for use as a supplemental fire water supply.

A.7.13.3.3 See NFPA 24, *Standard for the Installation of Private Fire Service Mains and Their Appurtenances*, for information on this subject.

A.7.13.3.4 See NFPA 13, *Standard for the Installation of Sprinkler Systems*, and NFPA 15, *Standard for Water Spray Fixed Systems for Fire Protection*, for information on these subjects.

A.7.13.4.1 One method of complying with this requirement could be through the installation of an automatic and/or manual fire alarm system as covered in *NFPA 72, National Fire Alarm Code*.

A.8.2.2 For additional information, see NFPA 497, *Recommended Practice for the Classification of Flammable Liquids, Gases, or Vapors and of Hazardous (Classified) Locations for Electrical Installations in Chemical Process Areas*.

A.8.2.4 NFPA 496, *Standard for Purged and Pressurized Enclosures for Electrical Equipment*, provides details for these types of installations.

Annex B Emergency Relief Venting for Fire Exposure for Aboveground Tanks

This annex is not a part of the requirements of this NFPA document but is included for informational purposes only.

B.1 General.

The requirements for emergency venting given in Table 4.2.5.2.3 and the modification factors in 4.2.5.2.6 are derived from a consideration of the following:

- (1) Probable maximum rate of heat transfer per unit area
- (2) Size of tank and the percentage of total area likely to be exposed
- (3) Time required to bring tank contents to boil
- (4) Time required to heat unwet portions of the tank shell or roof to a temperature where the metal will lose strength
- (5) Effect of drainage, insulation, and the application of water in reducing fire exposure and heat transfer

B.2 Derivation of Table 4.2.5.2.3.

Table 4.2.5.2.3 is based on a composite curve (see Figure B.2) that is composed of three straight lines when plotted on log–log graph paper. The curve can be defined in the following manner:

- (1) The first straight line is drawn between the points 400,000 Btu/hr at 20 ft² (1.86 m²) exposed surface area, and 4,000,000 Btu/hr at 200 ft² (18.6 m²) exposed surface area. The equation for this portion of the curve is $Q = 20,000A$, where Q is Btu/hr and A is the square feet of exposed shell area.
- (2) The second straight line is drawn between the points 4,000,000 Btu/hr at 200 ft² (18.6 m²) exposed surface area, and 9,950,000 Btu/hr at 1000 ft² (93 m²) exposed surface area. The equation for this portion of the curve is $Q = 199,300(A)^{0.566}$.
- (3) The third straight line is drawn between the points 9,950,000 Btu/hr at 1000 ft² (93 m²) exposed surface area, and 14,090,000 Btu/hr at 2800 ft² (260 m²) exposed surface area. The equation for this portion of the curve is $Q = 963,400(A)^{0.338}$.

The data for plotting the three lines are given in Table B.2.

Table B.2 Data for Figure B.2

$Q = 20,000A$		$Q = 199,300(A)^{0.566}$	
A	Q	A	Q
20	400,000	200	4,000,000
30	600,000	250	4,539,000
40	800,000	300	5,032,000
50	1,000,000	350	5,491,000
60	1,200,000	400	5,922,000
70	1,400,000	500	6,719,000
80	1,600,000	600	7,450,000
90	1,800,000	700	8,129,000
100	2,000,000	800	8,768,000
120	2,400,000	900	9,372,000
140	2,800,000	1000	10,000,000
160	3,200,000		
180	3,600,000		
200	4,000,000		

Note: For SI units, 1 ft² = 0.093 m²; 1 Btu/hr = 0.293 × 10⁻⁴ kW.

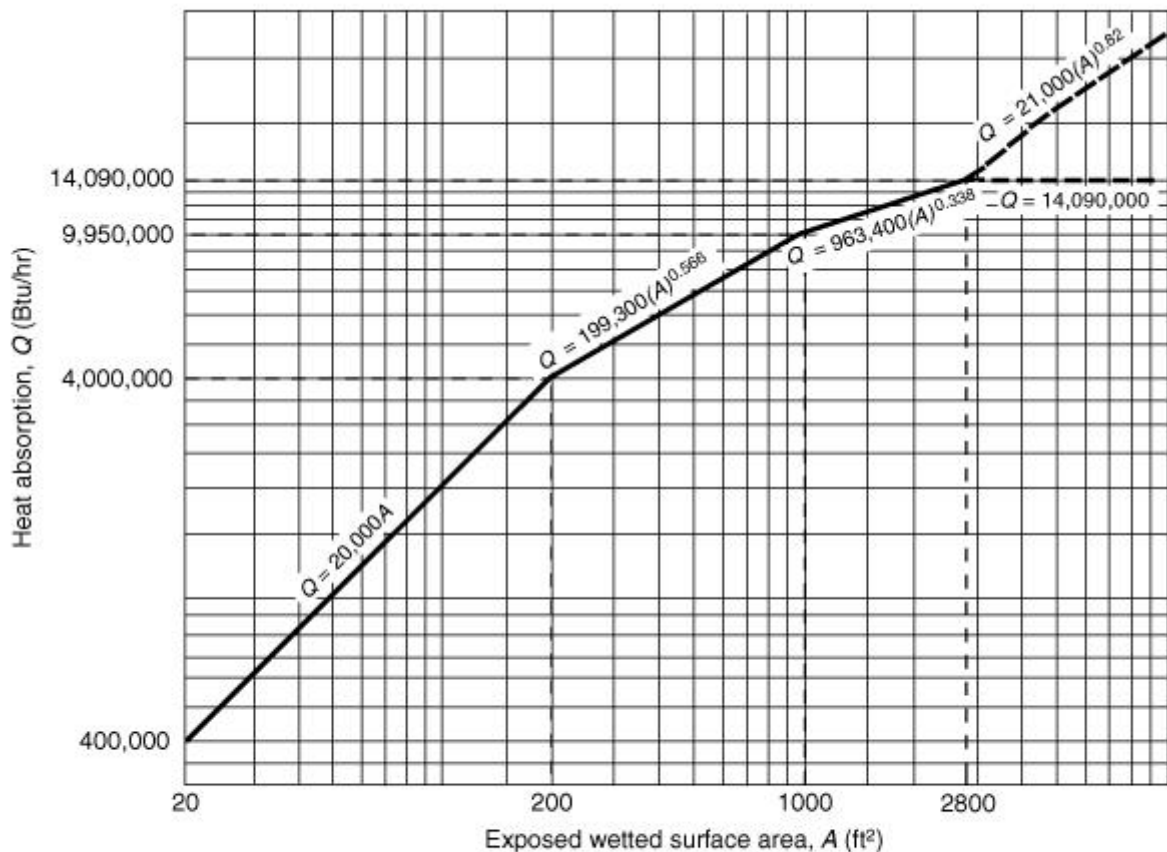

- Notes: (1) For SI units, 1 ft² = 0.09 m².
 (2) See Table B.4 for approximate wetted area for horizontal tanks.

FIGURE B.2 Curve for Determining Requirements for Emergency Venting During Fire Exposure.

B.2.1 For areas exceeding 260 m² (2800 ft²) it has been concluded that complete fire involvement is unlikely, and loss of metal strength from overheating will cause failure in the vapor space before development of maximum possible vapor evolution rate. Therefore, additional venting capacity beyond the vapor equivalent of 4100 kW (14,000,000 Btu/hr) shown in Table B.2 will not be effective or required.

B.2.2 For tanks and storage vessels designed for pressures over a gauge pressure of 6.9 kPa (1.0 psig), additional venting for exposed surfaces beyond 260 m² (2800 ft²) is believed to be desirable because, under these storage conditions, liquids are stored close to their boiling points. Therefore, the time to bring the container contents to boiling conditions is not necessarily significant. For these situations, a heat input value should be determined on the basis of the following:

$$Q = 21,000(A)^{0.82}$$

B.3 Estimation of Emergency Relief Venting for Specific Liquids.

The flow capacities estimated in Section B.2 are based on the assumption that the stored liquid will have the characteristics of hexane and the vapor liberated has been transposed to equivalent free air at 15.6°C (60°F) and 1 bar (14.7 psia or an absolute pressure of 101.3 kPa) by using appropriate factors in the following:

$$CFH = \frac{70.5Q}{L\sqrt{M}}$$

where:

CFH = cubic feet of free air per hour

70.5 = factor for converting pounds of gas to ft³ of air

Q = total heat input per hour (Btu)

L = latent heat of vaporization (Btu/lb)

M = molecular weight

No consideration has been given to possible expansion from the heating of the vapor above the boiling point of the liquid, its specific heat, or the difference in density between the discharge temperature and 15.6°C (60°F), because some of these changes are compensating.

Because tank vent valves are ordinarily rated in *CFH* standard air, the figures derived from Table 4.2.5.2.3 can be used with the appropriate tank pressure as a basis for valve selection.

Table B.3 gives constants that can be used to compute the vapor generated and equivalent free air for liquids other than hexane, where greater exactness is desired. Inspections of the table will show that the use of hexane in deriving Table 4.2.5.2.3 provides results that are within an acceptable degree of accuracy for the listed liquids.

Table B.3 Values of $L\sqrt{M}$ for Various Flammabl

Chemical	$L\sqrt{M}$
Acetaldehyde	1673
Acetic acid	1350
Acetic anhydride	1792
Acetone	1708
Acetonitrile	2000
Acrylonitrile	1930
n-Amyl alcohol	2025
iso-Amyl alcohol	1990
Aniline	1795
Benzene	1493
n-Butyl acetate	1432
n-Butyl alcohol	2185
iso-Butyl alcohol	2135
Carbon disulfide	1310
Chlorobenzene	1422
Cyclohexane	1414

Copyright NFPA

Table B.3 Values of $L\sqrt{M}$ for Various Flammabl

Chemical	$L\sqrt{M}$
Cyclohexanol	1953
Cyclohexanone	1625
o-Dichlorobenzene	1455
cis-Dichloroethylene	1350
Diethylamine	1403
Dimethylacetamide	1997
Dimethylamine	1676
Dimethylformamide	2120
Dioxane (diethylene ether)	1665
Ethyl acetate	1477
Ethyl alcohol	2500
Ethyl chloride	1340
Ethylene dichloride	1363
Ethyl ether	1310
Furan	1362
Furfural	1962
Gasoline	1370–1470
n-Heptane	1383
n-Hexane	1337
Hydrogen cyanide	2290
Methyl alcohol	2680
Methyl ethyl ketone	1623
Methyl methacrylate	1432
n-Octane	1412
n-Pentane	1300
n-Propyl acetate	1468
n-Propyl alcohol	2295
iso-Propyl alcohol	2225
Tetrahydrofuran	1428
Toluene	1500
Vinyl acetate	1532
o-Xylene	1538

Notes:

(1) For SI units, 1 Btu/lb = 2.3 kJ/kg.

(2) For data on other chemicals refer to available handbooks on properties of chemicals.

B.4 Estimation of Wetted Area for Horizontal Tanks.

Table B.4 gives the approximate wetted area for various sizes and configurations of

B.4 Estimation of Wetted Area for Horizontal Tanks.

Table B.4 gives the approximate wetted area for various sizes and configurations of horizontal tanks with flat heads, based on 75 percent of total shell area.

Table B.4 Approximate Wetted Areas for Horizontal Tanks with Flat Heads (Wetted Area Equals 75% Total Area in ft²)

Tank Length (ft)	Tank Diameter (ft)									
	3	4	5	6	7	8	9	10	11	12
3	32									
4	39	55								
5	46	65	88							
6	53	74	100	128						
7	60	84	112	142	173					
8	67	93	124	156	190	226				
9	74	102	136	170	206	245	286			
10	81	112	147	184	223	264	308	353		
11	88	121	159	198	239	283	329	377	428	
12	95	131	171	213	256	301	350	400	454	509
13	102	140	183	227	272	320	371	424	480	537
14	109	150	194	241	289	339	393	447	506	565
15	116	159	206	255	305	358	414	471	532	594
16	123	169	218	269	322	377	435	495	558	622
17	130	178	230	283	338	395	456	518	584	650
18	137	188	242	298	355	414	477	542	610	678
19		197	253	312	371	433	499	565	636	707
20		206	265	326	388	452	520	589	662	735
21		216	277	340	404	471	541	612	688	763
22		225	289	354	421	490	562	636	714	792
23		235	300	368	437	508	584	659	740	820
24		244	312	383	454	527	605	683	765	848
25			324	397	470	546	626	706	791	876
26			336	411	487	565	647	730	817	905
27			347	425	503	584	668	754	843	933
28			359	440	520	603	690	777	869	961
29			371	454	536	621	711	801	895	989
30			383	468	553	640	732	824	921	1018
31			395	482	569	659	753	848	947	1046
32				496	586	678	775	871	973	1074
33				510	602	697	796	895	999	1103
34				524	619	715	817	918	1025	1131
35				539	635	734	838	942	1051	1159

Table B.4 Approximate Wetted Areas for Horizontal Tanks with Flat Heads (Wetted Area Equals 75% Total Area in ft²)

Tank Length (ft)	Tank Diameter (ft)									
	3	4	5	6	7	8	9	10	11	12
42					751	866	987	1107	1233	1357
43					767	885	1008	1130	1259	1385
44						904	1029	1154	1284	1414
45						923	1051	1178	1310	1442
46						941	1072	1201	1336	1470
47						960	1093	1225	1362	1498
48						979	1114	1248	1388	1527
49						998	1135	1272	1414	1555
50							1157	1295	1440	1583
51							1178	1319	1466	1612
52							1199	1342	1492	1640
53							1220	1366	1518	1668
54							1246	1389	1544	1696
55							1263	1413	1570	1725
56								1437	1593	1753
57								1460	1622	1781
58								1484	1648	1809
59								1507	1674	1839
60								1531	1700	1866
61									1726	1894
62									1752	1923
63									1778	1951
64									1803	1979
65									1829	2007
66									1855	2036
67										2064
68										2092
69										2120
70										2149
71										2177
72										2205

Note: For SI units, 1 ft = 0.3 m; 1 ft² = 0.09 m².

Annex C Temporarily Out of Service, Closure in Place, or Closure by Removal of Underground Tanks

This annex is not a part of the requirements of this NFPA document but is included for informational purposes only.

Copyright NFPA

C.1 General.

C.1.1 Care is required not only in the handling and use of flammable or combustible liquids but also in the process of rendering temporarily out of service, closing, or removing tanks that have held flammable or combustible liquids. This is particularly true of underground service station tanks that are most frequently used for the storage of motor fuel and occasionally for the storage of other flammable or combustible liquids, such as crankcase drainings, which can contain some gasoline. Through carelessness, explosions have occurred because flammable or combustible liquid tanks have not been properly conditioned before being rendered temporarily out of service, closed, or removed.

C.1.2 In order to prevent accidents caused by improper conditioning, it is recommended that the procedures outlined in this annex be followed when underground tanks are temporarily taken out of service, closed, or removed.

C.1.3 Underground tanks taken out of service can be safeguarded or disposed of by any one of the following three means:

- (1) Placement in a temporarily out-of-service condition. Tanks should be rendered temporarily out of service only when it is planned that they will be returned to active service within a reasonable period or pending closure in place or closure by removal.
- (2) Permanent closure in place, with proper safeguarding.
- (3) Permanent closure by removal.

C.1.4 In cases where tanks are either rendered temporarily out of service or permanently closed, records should be kept of tank size, location, date of closure, and method used for placing the closed tank in a safe condition.

C.1.5 Procedures for carrying out each of the methods in C.1.3 of disposing of underground tanks are described in Section C.2 through Section C.6. No cutting torch or other flame- or spark-producing equipment should be used until the tank has been completely purged or otherwise rendered safe. In each case, the steps given should be carried out successively.

C.2 Rendering Tanks Temporarily Out of Service.

C.2.1 When the underground storage tank system (UST) is temporarily out of service for less than 3 months, the owners and operators should comply with the following:

- (1) Continue operation and maintenance of corrosion protection. Requirements can be found in U.S. Environmental Protection Agency (EPA), 40 CFR 280.31, "Technical Standards and Requirements for Owners and Operators of Underground Storage Tanks."
- (2) Continue operation and maintenance of any release detection in accordance with U.S. EPA, 40 CFR 280, Subpart D, or empty the UST system by removing all materials so that no more than 25 mm (1 in.) of residue, or 0.3 percent by weight of the total capacity of the UST system, remains in the system.

C.2.2 When a UST system is temporarily out of service for 3 months or more, owners and

operators should also comply with the following requirements:

- (1) Leave vent lines open and functioning
- (2) Cap or plug all other lines such as fill line, gauge opening, pump suction, and ancillary equipment and secure against tampering

C.3 Permanent Closure.

When a UST system is temporarily closed for more than 12 months, owners and operators should permanently close the UST system in accordance with U.S. EPA, 40 CFR 280.71–280.74. An extension of this 12-month period can be granted by the implementing agency. However, before such an extension can be applied for, a site assessment should be completed in accordance with U.S. EPA, 40 CFR 280.72.

C.4 Closure of Underground Tanks in Place.

C.4.1 At least 30 days before beginning closure procedures, owners and operators should notify the implementing agency of their intent to close unless such action is in response to corrective action proceedings.

C.4.2 Closure of tanks either in place or by removal requires the owners and operators to measure for the presence of a release where contamination is most likely to be present at the UST site. This requirement can be satisfied if one of the external release detection methods allowed in 40 CFR 280.43(e) and (f) is operating in accordance with the requirements in Part 280.43 at the time of closure and indicates no release has occurred.

C.4.3 Prepare a safe workplace by following the special safety precautions and cleaning and closure procedures in either of the following documents:

- (1) API 1604, *Removal and Disposal of Used Underground Petroleum Storage Tanks*
- (2) NEIWPC, *Tank Closure Without Tears: An Inspector's Safety Guide*

C.4.4 Safe work preparation should include the following:

- (1) No smoking in the area.
- (2) Shutting down all open flame and spark-producing equipment not necessary for the removal of the underground tank.
- (3) Using only hand tools to expose tank fittings and preparing for the vapor-freeing procedures.
- (4) Controlling static electricity or providing a conductive path to discharge static electricity by bonding or grounding equipment and vehicles.
- (5) Roping off tank area from pedestrian and vehicular traffic.
- (6) Locating and marking all utility lines on site.
- (7) Determining meteorological conditions. Vapor accumulation can occur on still and high-humidity days. Under these conditions, test the area for vapor accumulation (*refer to C.4.10*) and if present either provide additional forced ventilation or delay

the job until there is a breeze and it is less humid. Excavated soil should be tested for vapor release. Artificial ventilation or repeated turning of excavated soil might be necessary to avoid ignitable concentration of vapors.

- (8) Ensuring that personnel are wearing hard hats, safety shoes, and safety glasses and that a combustible gas indicator is available. Providing any other safety measures or methods that might be required to meet local requirements.

C.4.5 Remove all flammable or combustible liquid and residue from the tank and from all connecting lines.

C.4.6 Residual product and solids should be disposed of properly.

C.4.7 Excavate to the top of the tank.

C.4.8 Disconnect the suction, inlet, gauge, and all other tank fixtures. The vent line should remain connected until the tank is purged.

C.4.9 Either purge the tank of flammable vapors or inert the potentially explosive atmosphere in the tank.

C.4.9.1 Purging or ventilating the tank replaces the flammable vapors in the tank with air, reducing the flammable mixture of fuel and oxygen below the lower explosive limit or lower flammable limit (LFL). Two methods can be used to introduce air into the tank. One is the use of a “diffused-air blower” to pump air into the bottom of the tank through the fill pipe or a properly bonded air-diffusing pipe. The second method is the use of an “eductor-type air mover,” typically driven by compressed air. It draws vapors out of the tank and brings fresh air into the tank. The vent pipe can be used to exhaust vapors 3.7 m (12 ft) above grade and 0.9 m (3 ft) from any roof lines.

C.4.9.2 Inerting the tank does not replace the flammable vapors but instead reduces the concentration of oxygen to a level insufficient to support combustion (*refer to C.4.10*). Two inert gases can be used. Carbon dioxide gas can be generated by crushing and distributing dry ice evenly over the bottom of the tank. The dry ice will release carbon dioxide as it warms. Nitrogen gas can be pumped into the tank from a hose through the fill hole to the bottom of the tank. Oxygen will be reintroduced into the tank unless all holes are effectively plugged except for the vent line.

C.4.10 The tank should be tested to determine if it is safe by one of the following procedures:

- (1) When purging, a combustible gas indicator is used to measure the reduction in the concentration of flammable vapors. The meter reads from 0 to 100 percent of the LFL. The goal is to achieve a reading of 10 to 20 percent LFL for petroleum tanks.
- (2) When inerting, an oxygen meter is used to determine when a tank has been successfully inerted. The meter reads from 0 to 100 percent oxygen content. The goal is to achieve a reading of 1 to 10 percent, which is safe for most petroleum products.

C.4.11 Fill the tank completely with an inert solid material. One or more holes can be cut in the tank top if existing tank openings are not adequate for the introduction of the inert

material. Cap or remove remaining underground piping. The tank can now be backfilled.

C.5 Closure by Removal of Underground Tanks.

C.5.1 Observe all procedures listed under Section C.4, except for C.4.11, filling the tank with an inert solid material and backfilling the excavation.

C.5.2 After the tank has been made safe by following purging or inerting procedures and before it is removed from the excavation, plug or cap all accessible holes. One plug should have a 3 mm ($\frac{1}{8}$ in.) vent hole to prevent the tank from being subjected to excessive differential pressure caused by temperature changes. This vent should be positioned on top of the tank during subsequent transportation or storage.

C.5.3 Excavate around the tank to uncover it for removal. Remove the tank from the excavation and check for corrosion holes in the tank shell. Use screwed boiler plugs to plug any corrosion holes.

C.5.4 Tanks should be labeled with information about the former contents, present vapor state, vapor-freeing treatment method, and a warning against reuse.

C.5.5 Tanks should be removed from the site promptly and preferably the same day as taken from the ground because additional vapor can be released from liquid absorbed in tank wall corrosion or residues. However, before removal, the tank atmosphere must be checked to ensure the flammable vapor concentration does not exceed safe levels.

C.6 Disposal of Tanks.

C.6.1 If the reuse of a tank is permitted by the controlling jurisdiction, the tank should be certified that it is tight, structurally sound, and will meet all requirements of a new installation.

C.6.2 The storage of used tanks should be in secure areas where the public will not have access. Tanks should be rendered safe consistent with C.4.9 and C.4.10 and vented consistent with C.5.2.

C.6.3 If a steel tank is to be disposed of, it should be retested for flammable vapors and, if necessary, again rendered gas-free. Tanks that have been lined internally or coated externally with fiberglass, epoxy-based, or similar materials might not be accepted by scrap processors. Before releasing to a scrap metal dealer, a sufficient number of holes or openings should be made in the tank to render it unfit for further use. NFPA 326, *Standard for the Safeguarding of Tanks and Containers for Entry, Cleaning, or Repair*, provides information on safe procedures for such operations.

C.6.4 If the tank to be disposed of is nonmetallic or is a steel tank lined internally or coated externally with fiberglass, epoxy-based, or similar materials, it might not be accepted by scrap metal dealers. An alternative disposal method would be to cut up the tank in sections suitable for disposal in a sanitary landfill.

C.7 Record Keeping.

Record keeping is required to demonstrate compliance with closure requirements under 40

CFR 280.74. The results of the excavation zone assessment required in Part 280.72 should be maintained for at least 3 years after completion of permanent closure.

C.8 Resources.

Other resources to check for information related to safety during tank closure include the following:

- (1) API 1604, *Removal and Disposal of Used Underground Petroleum Storage Tanks*
- (2) API 1631, *Interior Lining of Underground Storage Tanks*
- (3) API 2015, *Cleaning Petroleum Storage Tanks*
- (4) API 2217A, *Guidelines for Work in Inert Confined Spaces in the Petroleum Industry*
- (5) API 2219, *Safe Operating Guidelines for Vacuum Trucks in Petroleum Service*
- (6) OSHA 2226, *Excavation & Trenching Operations*
- (7) NIOSH, *Criteria for Recommended Standard for Working in Confined Spaces*
- (8) NIOSH 87–113, *A Guide to Safety in Confined Spaces*
- (9) NFPA 69, *Standard on Explosion Prevention Systems* (Table with minimum oxygen levels necessary to support combustion for various products.)
- (10) NFPA 77, *Recommended Practice on Static Electricity*
- (11) NFPA 326, *Standard for the Safeguarding of Tanks and Containers for Entry, Cleaning, or Repair*
- (12) NFPA 306, *Standard for the Control of Gas Hazards on Vessels* (Practical procedures for vapor-freeing tanks and testing guidance.)
- (13) NEIWPC, *Tank Closure Without Tears: An Inspector's Safety Guide*

Annex D Development of Fire Protection Criteria Shown in Section 6.8 and Suggested Fire Protection for Some Containers of Flammable and Combustible Liquids Not Covered in Section 6.8

This annex is not a part of the requirements of this NFPA document but is included for informational purposes only.

D.1 General.

The development of suppression-oriented protection criteria for liquids in containers relies almost exclusively on the evaluation of large-scale fire test data. Characterization of fire development, fire spread to adjacent containers/materials, suppression system activation, and suppression system effectiveness based on first principles is not well established. Reliance on actual test data for all situations and scenarios is not, however, practical from a cost

Copyright NFPA

standpoint. Development of NFPA 30 protection criteria, therefore, relies on data from representative test scenarios. Alternative materials and scenarios are then evaluated in terms of the specific test data, historical test data, and engineering experience with the hazards. Pending the complete development of engineering tools to evaluate hazards, this approach represents the best method to meet the NFPA policy that codes and standards be scientifically based.

D.2 Summary of Fire Protection Design Criteria.

In developing the fire protection criteria set forth in Section 6.8, the NFPA 30 Container Protection Task Group evaluated numerous fire tests, 147 of which have been summarized in the *Directory of Fire Tests Involving Storage of Flammable and Combustible Liquids in Containers*, 3rd Ed. This directory was authored by David P. Nugent, Schirmer Engineering Corporation and is available by special arrangement with Schirmer Engineering Corporation from the Society of Fire Protection Engineers. Users of this code who wish to investigate details of the fire tests on which Section 6.8 is based are referred to this directory.

The summaries in Table D.2(a) through Table D.2(k) provide a brief justification statement for each entry in Table 6.8.2(a) through Table 6.8.2(k). Each entry in Table 6.8.2(a) through Table 6.8.2(k) includes a fire test reference number that appears in the last column of each table and is keyed to one of the following tables. The test numbers given in the justification statements refer to the tests reported in Nugent's directory. As noted, in some cases the NFPA 30 Container Protection Task Group exercised some judgment in evaluating the test data in order to develop fire protection criteria for various combinations of class of liquid, container type and size, and storage arrangement.

**Table D.2(a) Summary of Fire Test References
for Table 6.8.2(a)**

Ref. No.	Technical Justification and Test Identifier in Directory
1	Results of Test S-42, with extrapolation of data to allow increase in maximum ceiling height from 8.2 m (27 ft) to 9.1 m (30 ft).
2	Results of Test S-40, with extrapolation of data to allow increase in maximum ceiling height from 8.2 m (27 ft) to 9.1 m (30 ft).
3	Results of Tests S-22 through S-44, with emphasis on Test S-40, in which no ceiling sprinklers operated. Test S-26 justifies increasing maximum container size from 3.8 L (1 gal) to 19 L (5 gal).
4	Extrapolation of data in Ref. No. 3. Reduced hazard of Class IIIB liquids justifies increase in allowable storage height and maximum ceiling height and decrease in required ceiling sprinkler design area.

**Table D.2(a) Summary of Fire Test References
for Table 6.8.2(a)**

Ref. No.	Technical Justification and Test Identifier in Directory
5	Based on data in Ref. No. 3 above. Potential for larger spill justifies increase in ceiling sprinkler design density and disallowing quick-response sprinklers. In addition, Tests 572 through 576 indicate the need for face sprinklers at the first level at each rack upright to prevent collapse of the rack due to fire.
6	Results of Tests S-22 through S-44. Reduced hazard of Class IIIB liquids justifies increase in allowable storage height and maximum ceiling height and decrease in required ceiling sprinkler design density. Increased container size justifies increase in ceiling sprinkler design area compared to Ref. No. 4.
7	Results of Test S-31.
8	Results of Tests S-22 through S-44, with emphasis on Test S-40. Use of relieving-style container is expected to reduce potential for container rupture, but could contribute to rate of heat release during a fire.
9	Based on data in Ref. No. 4 and recognition that there is little advantage to use of relieving-style containers for Class IIIB liquids.
10	Results of Tests S-22 through S-46. See also Ref. No. 5. Increase in ceiling sprinkler design density justifies in-rack sprinklers at every other level, rather than at every level. In addition, Tests 572 through 576 indicate the need for face sprinklers at the first level at each rack upright to prevent collapse of the rack due to fire.
11	Based on data in Ref. No. 6 and recognition that there is little advantage to use of relieving-style containers for Class IIIB liquids.
12	Based on protection criteria recommended for portable tanks in Appendix D of 1993 edition of NFPA 30 and on results of Tests S-45 and S-46. In addition, Tests 572 through 576 indicate the need for face sprinklers at the first level at each rack upright to prevent collapse of the rack due to fire.

**Table D.2(a) Summary of Fire Test References
for Table 6.8.2(a)**

Ref. No.	Technical Justification and Test Identifier in Directory
13	Based on protection criteria recommended for portable tanks in Appendix D of 1993 edition of NFPA 30 and data in Ref. No. 6 and recognition that there is little advantage to use of relieving-style containers for Class IIIB liquids.

**Table D.2(b) Summary of Fire Test References
for Table 6.8.2(b)**

Ref. No.	Technical Justification and Test Identifier in Directory
1	Results of Test S-15.
2	Results of Test S-5 and Tests S-13 through S-15, with particular emphasis on Test S-5.
3	Results of Test S-5 and Tests S-13 through S-18, with application of engineering judgment to Test S-13.
4	Results of Test S-5 and Tests S-19 through S-21. Larger container size justifies increased ceiling sprinkler design density over that specified in Ref. No. 2.
5	Results of Test S-5 and Tests S-13 through S-18 and protection criteria recommended in Appendix D, Table D-2.2 of 1993 edition of NFPA 30. Quick-response sprinklers are allowed based on experience in testing containers not greater than 19 L (5 gal) capacity.
6	Results of Test S-5 and Tests S-13 through S-21 and protection criteria recommended in Appendix D, Table D-2.2 of 1993 edition of NFPA 30.
7	Results of Test S-5 and Tests S-13 through S-21 and protection criteria recommended in Appendix D, Table D-2.2 of 1993 edition of NFPA 30.
8	Results of Test S-18, with consideration given to Tests S-16 and S-17.
9	Results of Test S-5 and Tests S-19 through S-21. Use of relieving-style containers justifies increase in maximum ceiling height.

**Table D.2(b) Summary of Fire Test References
for Table 6.8.2(b)**

Ref. No.	Technical Justification and Test Identifier in Directory
10	Based on data in Ref. Nos. 4 and 9. Increased ceiling sprinkler design density allows storage two tiers high.
11	Based on data in Ref. No. 5 and recognition that there is little advantage to use of relieving-style containers for Class IIIB liquids.
12	Based on data in Ref. No. 6 and recognition that there is little advantage to use of relieving-style containers for Class IIIB liquids.
13	Based on data in Ref. No. 7 and recognition that there is little advantage to use of relieving-style containers for Class IIIB liquids.
14	Based on protection criteria recommended in Appendix D, Table D-2.2 of 1993 edition of NFPA 30, with consideration given to results of Tests S-19 through S-21.
15	Based on protection criteria recommended in Appendix D, Table D-2.2 of 1993 edition of NFPA 30, with consideration given to results of Tests S-19 through S-21.
16	Based on protection criteria recommended in Appendix D, Table D-2.2 of 1993 edition of NFPA 30, with consideration given to results of Tests S-19 through S-21.
17	Based on protection criteria recommended in Appendix D, Table D-2.2 of 1993 edition of NFPA 30, with consideration given to results of Tests S-19 through S-21.

**Table D.2(c) Summary of Fire Test References
for Table 6.8.2(c)**

Ref. No.	Technical Justification and Test Identifier in Directory
1	Results of Test S-33, with consideration given to results of Tests S-32 and S-34.
2	Results of Tests S-45 and S-46.
3	Results of Tests S-45 and S-46. Reduced hazard of Class IIIB liquids justifies in-rack sprinklers at every other level, rather than at every level.

**Table D.2(c) Summary of Fire Test References
for Table 6.8.2(c)**

Ref. No.	Technical Justification and Test Identifier in Directory
4	Results of Test S-33, with consideration given to results of Tests S-32 and S-34. Use of relieving-style containers justifies reduction in in-rack sprinkler design criteria, compared to that specified in Ref. No. 1.
5	Results of Tests S-45 and S-46. Use of relieving-style containers justifies reduction in in-rack sprinkler design criteria, compared to that specified in Ref. No. 1.
6	Based on data in Ref. No. 3.

**Table D.2(d) Summary of Fire Test
References for Table 6.8.2(d)**

Ref. No.	Technical Justification and Test Identifier in Directory
1	Results of Test S-12, with extrapolation of data to allow increase in maximum ceiling height from 7.6 m (25 ft) to 9.2 m (30 ft).
2	Results of Test S-6, with extrapolation of data to allow increase in maximum ceiling height from 7.6 m (25 ft) to 9.2 m (30 ft).
3	Results of Test S-6 and Tests S-19 through S-21, with extrapolation of data to allow increase in maximum ceiling height from 7.6 m (25 ft) to 9.2 m (30 ft).
4	Results of Test S-51.
5	Based on data in Ref. No. 3. Use of relieving-style containers allows storage two tiers high.
6	Results of Test S-55.
7	Results of Test S-56.

**Table D.2(e) Summary of Fire Test
References for Table 6.8.2(e)**

Ref. No.	Technical Justification and Test Identifier in Directory
1	Results of Tests P-21 through P-31.

**Table D.2(e) Summary of Fire Test
References for Table 6.8.2(e)**

Ref. No.	Technical Justification and Test Identifier in Directory
---------------------	---

**Table D.2(f) Summary of Fire Test
References for Table 6.8.2(f)**

Ref. No.	Technical Justification and Test Identifier in Directory
1	Results of Test S-47.

**Table D.2(g) Summary of Fire Test
References for Table 6.8.2(g)**

Ref. No.	Technical Justification and Test Identifier in Directory
1	Results of Tests P-32 through P-35.
2	Results of Tests P-40 through P-43.
3	Results of Tests P-36 through P-38.

**Table D.2(h) Summary of Fire Test
References for Table 6.8.2(h)**

Ref. No.	Technical Justification and Test Identifier in Directory
1	Results of Test S-68.
2	Results of Test S-70.
3	Results of Test S-60.
4	Results of Test S-62.
5	Results of Test S-65.
6	Results of Tests S-57, S-58, and S-59.
7	Results of Test S-66.

**Table D.2(i) Summary of Fire Test
References for Table 6.8.2(i)**

Ref. No.	Technical Justification and Test Identifier in Directory
1	Results of Tests P-48, P-49, and P-50.
2	Results of Tests P-51, P-52, and P-53.

**Table D.2(j) Summary of Fire Test
References for Table 6.8.2(j)**

Ref. No.	Technical Justification and Test Identifier in Directory
1	Results of Tests P-54 and P-55.

**Table D.2(k) Summary of Fire Test
References for Table 6.8.2(k)**

Table D.2(k) Summary of Fire Test References for Table 6.8.2(k)

Ref. No.	Technical Justification and Test Identifier in Directory
1	Results of Tests S-77 through S-82.

D.3 Recommended Design Criteria for Class IA Liquids.

There are a number of commodities for which there was no or insufficient test data to develop definitive protection tables. One example is Class IA liquids. Table D.3(a) through Table D.3(c) contain the protection that was contained in Appendix D of the 1993 edition of NFPA 30 for Class IA liquids.

Additional useful information for evaluating fire risk can be found in the technical report, “A Fire Risk Analysis Model for Assessing Options for Flammable and Combustible Liquid Products in Storage and Retail Occupancies” by Dr. John R. Hall, Jr., NFPA.

Table D.3(a) Foam-Water Sprinkler Protection for Single- or Double-Row — Metal (for Nonmiscible or Miscible Liquids >50%)

Liquid Class	Container Size and Arrangement (gal)	Storage Height (ft)	Ceiling Height (ft)	Ceiling		1
				Sprinkler Type		
				Orifice ¹	Response ²	
IA	>5 and ≤60	25	30	STD or LO	SR	

Notes:

(1) For SI units, 1 ft = 0.3 m; 1 psi = 6.9 kPa; 1 gal = 3.8 L; 1 gpm/ft² = 40.7 L/min/m² = 40.7 mm/min.

(2) Space in-rack sprinklers on maximum 9 ft centers, staggered vertically. Base design on 30 gpm per head, v upper three levels. Sprinklers are STD or LO, QR or SR, 165°F-operating temperature, with shields. Hydraulic three levels operating simultaneously when using a pre-primed foam-water system installed in accordance with *Sprinkler and Foam-Water Spray Systems*, and maintained according to NFPA 25, *Standard for the Inspection Systems*.

¹ELO sprinklers are preferred when installed according to the requirements of NFPA 13, *Standard for the Installation* (pressure). STD = standard orifice, LO = large orifice, ELO = extra-large orifice.

²SR = standard response.

³High-temperature ceiling sprinklers.

Table D.3(b) Water Sprinkler Protection for Single- or Double-Row R — Metal (for Nonmiscible or Miscible Liquids >50%)

Liquid Class	Container Size and Arrangement (gal)	Storage Height (ft)	Ceiling Height (ft)	Ceiling	
				Sprinkler Type	
				Orifice ¹	Response ²

**Table D.3(b) Water Sprinkler Protection for Single- or Double-Row R
— Metal (for Nonmiscible or Miscible Liquids >50%)**

Liquid Class	Container Size and Arrangement (gal)	Storage Height (ft)	Ceiling Height (ft)	Ceiling	
				Sprinkler Type	
				Orifice ¹	Response ²
IA	≤ 5	25	30	LO or ELO	SR
	>5 and ≤ 60	25	30	LO or ELO	SR

Notes:

(1) For SI units, 1 ft = 0.3 m; 1 psi = 6.9 kPa; 1 gal = 3.8 L; 1 gpm/ft² = 40.7 L/min/m² = 40.7 mm/min.

(2) Space in-rack sprinklers on maximum 9 ft centers staggered vertically, 30 gpm per head, STD or LO, QR, sprinklers each level (upper three levels) operating. Eight sprinklers operating, if only one level.

¹ELO sprinklers are preferred when installed according to the requirements of NFPA 13, *Standard for the Inst* pressure). STD = standard orifice, LO = large orifice, ELO = extra-large orifice.

²SR = standard response.

³High-temperature ceiling sprinklers.

**Table D.3(c) Water Sprinkler Protection of Bulk or Palletized Stor:
— Metal (for Nonmiscible or Miscible Liquids >50%)**

Liquid Class	Container Size and Arrangement (gal)	Storage Height (ft)	Ceiling Height (ft)	Sprinkler Type	
				Orifice ¹	Re
				IA	≤ 5
>5 and ≤ 60	5 (1-high)	N/A	LO or ELO		

Notes:

(1) For SI units, 1 ft = 0.3 m; 1 psi = 6.9 kPa; 1 gal = 3.8 L; 1 gpm/ft² = 40.7 L/min/m² = 40.7 mm/min.

(2) Minimum hose stream demand 750 gpm for 2 hours.

¹ELO sprinklers are preferred when installed according to the requirements of NFPA 13, *Standard for the Inst* pressure). STD = standard orifice, LO = large orifice, ELO = extra-large orifice.

²SR = standard response.

³High-temperature ceiling sprinklers.

D.4 Recommended Design Criteria for High Flash Point Class IIIB Liquids.

Table D.4(a) provides recommended sprinkler system design criteria for Class IIIB liquids having flash points greater than 230°C (450°F). [See also Table D.4(b)].

**Table D.4(a) Water Sprinkler Protection for Single-, Double-, or Multi-Row Open Fram
Point ≥ 450°F in Plastic Containers (for nonmiscible combustible liquids or miscible co
volume)**

D.4 Recommended Design Criteria for High Flash Point Class IIIB Liquids.

Table D.4(a) provides recommended sprinkler system design criteria for Class IIIB liquids having flash points greater than 230°C (450°F). [See also Table D.4(b)].

Table D.4(a) Water Sprinkler Protection for Single-, Double-, or Multi-Row Open Rack Point $\geq 450^\circ\text{F}$ in Plastic Containers (for nonmiscible combustible liquids or miscible combinations)

Liquid Type or Closed-Cup Flash Point ($^\circ\text{F}$)	Container Size (gal)	Maximum Building or Ceiling Height (ft)	Packaging Type	Maximum Storage Height (ft)	Minimum Aisle Width (ft)	Rack Width (ft)
≥ 450	≤ 5	30	Cartoned	25	8	≤ 9
				15	8	≤ 9
			Uncartoned or mixed cartoned and uncartoned	25	8	≤ 9

Note: For SI units, 1 ft = 0.3 m.

See Table D.4(b) for references to fire tests on which the protection criteria given in this table are based.

Table D.4(b) Summary of Fire Test References for Table D.4(a)

Ref. No.	Technical Justification and Test Identifier in Directory
1	Results of Tests P-21 through P-31.
2	Results of Test P-46.
3	Results of Tests P-56 and P-57.
4	Results of Test P-44.

D.4.1 Fire Protection Scheme C.

Copyright NFPA

D.4.1.1 In-rack sprinklers should be installed in accordance with Figure D.4.1.1(a) and Figure D.4.1.1(b). Vertical baffles should not be provided between in-rack sprinklers.

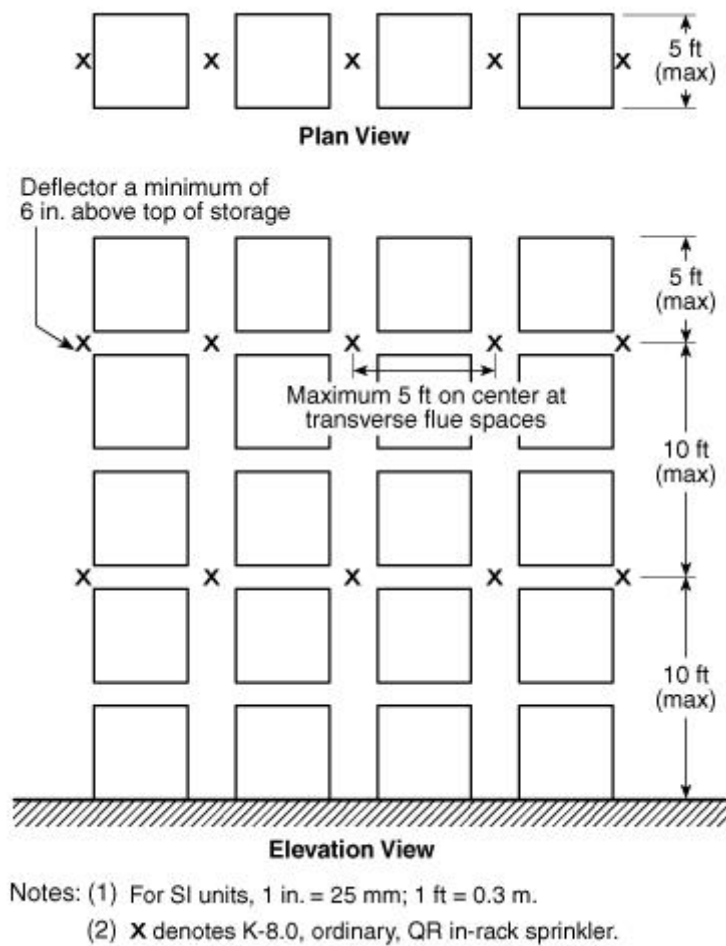

FIGURE D.4.1.1(a) Single-Row Rack Sprinkler Layout.

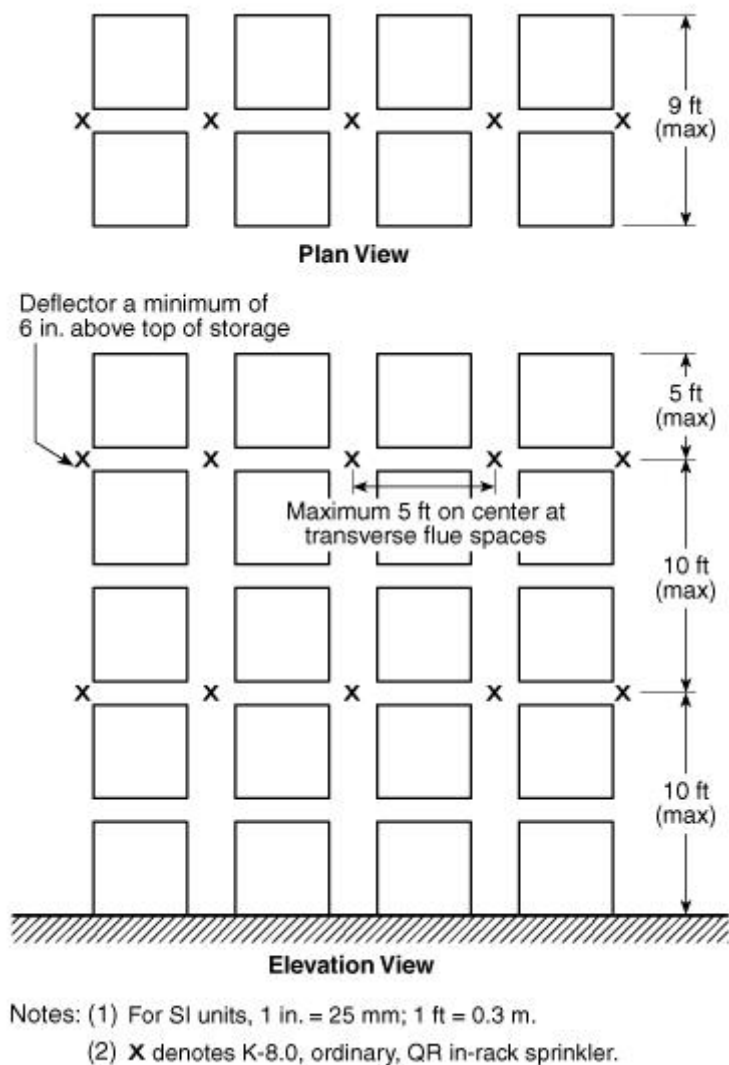

FIGURE D.4.1.1(b) Double-Row Rack Sprinkler Layout.

D.4.1.2 Listed or approved K-8.0 in., ordinary temperature-rated, quick response in-rack sprinklers should be installed. The in-rack sprinklers should be designed to provide 113 L/min (30 gpm) out of the hydraulically most remote eight sprinklers if one level is installed or the most remote fourteen sprinklers (seven on two levels) if two or more levels are provided.

D.4.1.3 Ceiling sprinklers should be designed to provide a minimum density of 12.2 mm/min (0.3 gpm/ft² or 12.2 L/min per m²) over the most remote 185 m² (2000 ft²) using K-8.0 or K-11.2 orifice, ordinary temperature-rated, standard response spray sprinklers.

D.4.1.4 The ceiling and in-rack sprinkler demands should be balanced at the point of connection to the water supply. A 1900 L/min (500 gpm) hose stream allowance should be provided.

D.5 Recommended High-Expansion Foam Fire Protection for Nonmiscible Liquids.

Table D.5 provides recommended design criteria for high-expansion foam protection for Class IB, Class IC, Class II, and Class III liquids in plastic containers in corrugated cardboard cartons.

Table D.5 High-Expansion Foam Protection of Single- and Double-Row, Open-Frame R: Plastic Containers

Liquid Class (non-polar liquids)	Container Size (gal)	Maximum Storage Height (ft)	Maximum Ceiling Height (ft)	Maximum Submergence Time (minutes)
IB, IC, II, IIIA, IIIB	≤ 1 ^a	18	33	2

^aLiquids in polyethylene or polypropylene containers packaged in corrugated cardboard cartons.

^bSee Table D.2.7 for references to fire tests on which fire protection criteria are based.

D.5.1 The foam system should be designed and installed in accordance with NFPA 11A, *Standard for Medium- and High-Expansion Foam Systems*, with this section, and with Table D.5.

D.5.2 There should be at least two foam generator units drawing fresh inlet air from an area outside of the area being protected.

D.5.3 Submergence time should not exceed 2 minutes for either sprinklered or unsprinklered areas. Failure of a single foam generator should not result in a submergence time exceeding 4 minutes.

D.5.4 The foam system should be activated by a supplemental detection system capable of detecting a fire originating anywhere within the storage area. Foam system activation should be preceded by a 20 second pre-activation room egress alarm.

D.5.5 Storage of liquids in plastic containers should be in a room separated from other occupancies by minimum 2-hour fire-rated construction. The storage room should be equipped with automatic self-closing Class A or B doors that are interlocked to the detection system.

D.5.6 The roof or ceiling of the storage area should be provided with either of the following:

- (1) A minimum 1-hour fire-resistive protection for roof or ceiling structural members
- (2) Ceiling sprinklers at a minimum density of 18.3 L/min per m² (0.45 gpm) over the entire room to protect against high ceiling temperatures during the time required for foam submergence.

D.5.7 Liquid containment should be provided for rooms storing liquids in plastic containers. The liquid containment should provide 100 mm (4 in.) minimum containment. Where ceiling sprinkler protection is used, a drainage and containment system capable of retaining at least 20 minutes of sprinkler discharge should be provided.

D.5.8 Rack storage should be limited to single- or double-row racks. Bay width should not

exceed 2.7 m (9 ft).

D.5.9 Racks should be provided with vertical barriers meeting the following requirements:

- (1) Barriers should be constructed of plywood at least 10 mm thickness ($\frac{3}{8}$ in.) or by sheet-metal of at least 22 gauge thickness.
- (2) Barriers should be located at each rack upright and should extend from rack face through the flue space to the opposite rack face of the storage rack assembly.

D.5.10 Aisle width should not be not less than 2.3 m (7.5 ft). See Table D.5.

D.5.11 These recommendations are based on a series of fire tests conducted by Ansul, Inc. to explore the efficacy of high-expansion foam fire protection on fires involving flammable liquids in plastic containers.

Annex E Suggested Test Protocol for Developing Fire Protection for Containers of Flammable and Combustible Liquids

This annex is not a part of the requirements of this NFPA document but is included for informational purposes only.

E.1 Introduction.

The development of fire protection criteria for liquids in containers relies almost exclusively on the evaluation of data from large-scale fire tests and engineering judgment. Characterization of fire development, fire spread to adjacent containers or materials, suppression system activation, and effectiveness of the suppression system based on first principles (i.e., governing scientific theory) is not well established. Reliance on actual test data for all situations and scenarios is not, however, practical from a cost standpoint. The development of the fire protection criteria in Section 6.8 of this code, therefore, relies on data from representative test scenarios and assessment of the risk. Alternative materials and scenarios are then evaluated in terms of the specific test data, historical test data, engineering experience with the hazards, and an assessment of the risk. Pending complete development of engineering tools to evaluate the fire hazards of flammable and combustible liquids, this approach represents the best method to meet the NFPA policy that codes and standards be scientifically based.

This annex provides an example protocol for the testing of flammable and combustible liquids stored in containers. In many cases, test data are then interpolated or extrapolated to develop fire protection design criteria by which the stored commodities can be considered protected. The term *protected* could be interpreted as defining storage where there is essentially zero risk of an uncontrolled incident. Because zero risk is unattainable, it is important that designers and regulators be aware of the limitations when applying the protection criteria based on fire test data and engineering extrapolation. The limitations of the protection criteria are also described in this annex.

With the introduction and widespread use of larger containers, such as intermediate bulk containers (IBCs), and the introduction of alternative container materials, there is a need to

Copyright NFPA

evaluate these materials from a fire performance standpoint. There is a need to provide manufacturers, warehouses, and enforcement officials with guidance on developing and evaluating protection criteria where data are not currently available. The following example test protocol is intended to outline guidance for conducting representative fire tests to establish protection criteria for liquids in containers. Specifically, this outline is developed for liquids in large containers [i.e., greater than 20 L (5.3 gal)]. While there is a substantial amount of data for smaller containers, there is a lack of data for large containers. (See E.2.5 and E.2.6). Most of these data are for 55 gal (208 L) drums.

E.2 Example Fire Test Protocol for Evaluating Liquids in Large Containers.

Important variables in evaluating hazards for liquids in small containers have been identified (Nugent, 1994). These include liquid properties, container design and size, packaging material, ignition scenario, storage arrangement, and sprinkler system design parameters.

Of particular importance for large containers is control of pressure in the container to prevent a violent rupture and the prevention of a large discharge of liquid. While these are a problem with smaller containers, the hazard to test facilities and personnel increases dramatically for larger containers. A fundamental measure of performance is the limitation of pressure buildup in the container and maintenance of container integrity to prevent a large spill. Prevention of a violent rupture should be tempered by the discharge of liquid and associated heat release through pressure-relieving mechanisms. The pressure-relieving mechanisms can be a designed-in feature or can be inherent in the container material. Container integrity, along with pile or rack stability, is important to prevent a large discharge of liquid. Suppression systems might not be adequate to control a large release of liquid. Engineering tools are available to evaluate specific consequences of uncontrolled pool fires on facility integrity (Gewain, 1996).

The information that follows is provided to aid in the development of protection criteria similar to that developed in Table 6.8.2(a) through Table 6.8.2(d) for steel drums. The intent is to provide guidance for the acceptance of alternative materials/designs under the “protected” classification of stored liquids. The primary basis of this outline is previous testing of drum storage (e.g., Newman et al., 1975).

E.2.1 Storage Configuration.

E.2.1.1 Facility. If containers are to be protected indoors, tests should be conducted in an enclosed facility with minimal impact from the outside environment. In particular, the building height should be representative of the proposed indoor storage height. Building height affects response time of the suppression system, penetration of suppression agent through the fire plume, and response of building structural elements to the threat.

E.2.1.2 Storage Array. A representative array should be selected (e.g., solid pile storage or rack storage). Arrays should consider the width of aisles to adjacent stored materials and whether these materials have higher or lower ignition and fire growth characteristics.

E.2.1.3 Container. The container storing the liquid should be representative of a production-type unit, unless the evaluation is a scoping series to determine container effects. Potential venting capabilities of a container should be identified (i.e., the thermally “weak

link” of the constructed assembly). If the container will have an outer wrapping, packaging, or pallet, this should be considered in the overall “container” system.

E.2.1.4 Liquid in Container. The most hazardous liquid to be stored should be evaluated. The hazard of a liquid should be assessed based on its volatility (vapor pressure), heat of combustion, specific gravity, miscibility (water solubility), ignition temperature, flash point, fire point, boiling point, and vapor density. The NFPA 30 rating system, based on flash point, vapor pressure, and boiling point, can be used as a guide to assess the hazard. The other properties should be considered, as they can affect both the hazard and the suppression system effectiveness.

E.2.1.5 Liquid Classes. Class IA liquids should be considered independently from other liquids because of their inherent hazards. Protection criteria can be developed for different classes of liquids, for example, motor oils that have protection criteria different from those for Class IB liquids. For a maximum reasonable hazard, n-heptane has been used for general evaluation for liquids up to and including Class IB. When tests are performed on large containers, water can be substituted in place of the actual flammable liquid to improve the overall safe conduct of the test. It is important to include liquid in the container. Internal pressure should be recorded. The liquid also serves as a heat sink for the container. Structural failure of the container can occur where there is no liquid interfacing with the container (Newman et al., 1975). The container ullage (vapor space) should be representative of actual conditions.

E.2.2 Protection System.

E.2.2.1 The protection system proposed for adoption should be represented in the actual test (e.g., deluge sprinkler system, wet or dry pipe closed-head system, foam system, or gaseous agent system). Where system actuation is dependent on auxiliary equipment (e.g., detectors), these devices should be included in the test with representative spacing and response characteristics.

E.2.2.2 For sprinkler suppression systems, representative application rates and sprinkler spacing that would be proposed for adoption should be used.

E.2.2.3 For tests involving closed-head sprinklers, appropriate sprinkler orifice sizes, temperature rating, and response time index (RTI) should be identified and utilized.

E.2.2.4 For deluge and gaseous agent system tests, appropriate detection equipment proposed for protection should be used in testing.

E.2.2.5 For foam system tests, prepriming or the actual foam discharge time from sprinklers should be addressed. The foam concentrate should be listed or approved for the type of liquid.

E.2.3 Fire Scenario.

E.2.3.1 The fire scenario is crucial in determining the hazard of the stored product. It is recognized that an installed suppression system might not be able to protect against an absolute worst-case scenario (e.g., the total release of multiple storage containers). For large containers, the rapid release of contents can pose a significant challenge to an installed

suppression system. This is particularly true if it is a highly volatile liquid (e.g., Class I liquid). The philosophy for determining protection effectiveness is predicated on a reasonable anticipated threat. Even with an installed suppression system, there is some risk of a significant loss. Part of this risk is associated with suppression system reliability, which should be addressed in the actual design/specification of protection systems.

E.2.3.2 A representative scenario for large containers was developed during drum storage tests (Newman et al., 1975). The scenario was a liquid gravity leak of 2 to 15 gpm (7.6 to 56.7 L/min) from a hole at or near the bottom of a container. This leak can be simulated by flow from a pipe. If containers are stacked or placed more than one high, then the simulated container leak should be placed high in the total array. The leak should be allowed to flow prior to ignition, simulating fuel spread after the mishap and a delay in ignition. In the tests, 10 gal (38 L) of liquid was allowed to spill before ignition. Additional details on the effects of spill rate and initial spill size for tests involving an aqueous film-forming foam suppression system are provided in other references (Young, et al., 1975).

An alternative worst-case scenario could be the total release of liquid from a large container, with ignition delayed until the contents are totally discharged. Ignition of this large pool fire can severely challenge an installed suppression system.

E.2.3.3 If the scenario involves a flowing fuel fire, the recommended length of the test should be equal to the total time of the flow from one container. Alternatively, the evaluation can be terminated shortly after total extinguishment. Time should be allowed to determine any post-extinguishment pressure buildup in containers or subsequent container failure due to inadequate cooling. For water and foam systems, fire control will likely be the measure of performance instead of extinguishment because it is unlikely that the three-dimensional running fuel fire will be extinguished with these agents. If a larger spill rate is used, a reduced test time equal to the time to discharge the contents of one container can be appropriate. The length of a pool fire test would be based on the success or failure of the suppression system to control/extinguish the fire. For portable tanks and intermediate bulk containers, a specific length of fire protection time can be identified.

E.2.4 Measures of Performance.

E.2.4.1 Criteria. Acceptable performance should include, but not be limited to, the following:

- (1) Prevent pressure buildup in containers or actual violent ruptures
- (2) Prevent substantial loss of liquid from a container
- (3) Limit the number of sprinklers operating
- (4) Prevent ignition of adjacent target arrays or failure to control a fire in an adjacent target array
- (5) Limit temperature of structural or rack steel
- (6) Control sustained ceiling gas temperatures
- (7) Prevent collapse of the stored containers or arrays

E.2.4.2 Type of Container. The type of container material will affect the establishment of the performance criteria. The prevention of a violent rupture is an important characteristic. The loss of some liquid from a container (particularly by controlled venting) can be deemed acceptable or even preferable. Catastrophic failure of a container (e.g., total content release) can be deemed unacceptable. The resulting large spill might not be controlled (particularly if water sprinklers are used) and can lead to cascading container failures.

E.2.4.3 Preliminary Testing. Scoping tests can be required to determine failure mechanisms and worst-case situations for specific container materials. An example of scoping tests performed to determine failure mechanisms of small metal and plastic containers is detailed in a research report by Hill (1991). Steel drum failure mechanisms are described in a research report by Newman and others (1975). There is a lack of published information on large container failure mechanisms, particularly for IBCs and nonmetallic or composite drums (e.g., fiber drums).

E.2.4.4 Pressure Buildup. 1.0 bar (15 psi or 103 kPa) is an example of a critical pressure in steel drums, above which violent rupture can occur (Newman et al., 1975). Many drums are now rated at 3.0 bar (44 psi or 300 kPa), and some might be rated as high as 4.8 bar (70 psi or 480 kPa).

E.2.4.5 Loss of Liquid. Loss of any substantial amount of liquid from a container is generally considered as a criterion for failure. For the originally involved container, this can be loss of contents at a rate greater than the design scenario spill rate. Fire spread to the outer limits of the test array is generally considered a failure. For adjacent or target arrays, the level of fire involvement should be considered. Loss due to vapor venting can be considered acceptable. For metallic containers, loss of liquid to a violent rupture can be considered unacceptable.

E.2.4.6 Number of Sprinklers Operating and Operating Time. The number of sprinklers operating and their operating time can be used as a judgment of overall suppression system effectiveness. As the number of sprinklers operating increases, the probability of overall success decreases. The philosophy in combustible/flammable liquid protection has shifted from traditional warehouse success criteria, where a “success” could be judged for a test involving the operation of 30 or more sprinklers. The trend in liquid protection is for more rapid actuation and cooling/control through the use of lower RTI, intermediate level, larger orifice, and ESFR sprinklers.

E.2.4.7 Ignition of Target Arrays. Prevention of the ignition of adjacent targets (e.g., across aisles) is a fundamental measure of performance. If target arrays ignite, adequate protection should be provided (e.g., through the use of in-rack sprinklers or increased suppression agent rate).

E.2.4.8 Integrity of Structural Steel. Structural steel, in the form of building columns, beams, or rack elements, potentially fails at about 650°C to 700°C (about 1200°F to 1300°F). Scenarios where elements reach this temperature for any prolonged time can be judged unsuccessful for “protected” situations.

E.2.4.9 Integrity of Storage Array. Collapse of stored containers inherently increases the risk of container liquid discharge. It also increases the potential for shielding of a flowing fuel

or pool fire, with a resulting increase in violent rupture potential or catastrophic liquid discharge.

E.2.4.10 Spills. Spills of any magnitude might not be suppressed by water-only suppression systems. Water can act to cool containers, but it also spreads the pool fire. For situations where there is the potential for large spills, floor drainage systems can be used to mitigate the spread of burning liquids. The area contained within the drains can be considered for establishing sprinkler design operating areas. Alternatively, foam-water sprinkler systems can be used to control/suppress floor pool fires to prevent burning liquid spread. Where there is rack storage, in-rack sprinklers at every level have demonstrated good cooling for drum storage (Newman et al., 1975).

E.2.4.11 Test Documentation. Test documentation should include test setup, results, and damage assessment. Photographic and video documentation is desirable.

E.2.5 Probability of a Fire Incident and Reliability of Suppression Systems.

E.2.5.1 Inherent in the current “unprotected” and “protected” concepts of Chapter 4 is a qualitative judgment of unacceptable and acceptable risk. If all other relevant fire and property loss parameters are equal, “unprotected” facilities have a greater relative risk of experiencing an uncontrolled fire that will result in a large loss than will “protected” facilities. An essential part of a risk analysis is identifying all the factors that will contribute to the probability of a fire incident. In addition, the factors leading to a nonoperable suppression system need to be identified. Only after comparing these two probabilities, fire event and system failure, can an accurate assessment of risk be accomplished.

Minimizing the risk in either unprotected or protected facilities can be accomplished by reducing the probability of a fire. These types of “fire safety” practices are common and range from good housekeeping and other management program controls to inherently less combustible and ignitable process and facility designs. This encompasses a broad range of elements, but all contribute to lessening the probability of a fire. In undertaking a risk-based approach to fire safety, as many as possible of these contributing elements should be identified. Once this is done, steps should be taken, within the set of identified elements, to reduce or eliminate their individual probability of occurring.

E.2.5.2 In facilities where fire suppression systems are used to reduce the risk of loss due to fire, the suppression system should be examined to determine its reliability. Suppression systems are multicomponent assemblies and determining the reliability of the system involves knowing or estimating, within acceptable limits, the probabilities of failure of the individual components or subsystems. It is also essential to understand the conceptual design of the system as it relates to interaction of the components. One method of assessing reliability is by using the system schematics to construct fault trees. The fault trees then serve as system models and the failure probabilities are propagated through calculation to determine the overall probability of system failure. The fault trees can be extended by additional “AND” logic gates (fire event at the same time as system failure) to determine the suppression system’s conditional probability of failure.

E.2.5.3 As with any quantitative probabilistic analysis, the quality of the data used to determine the estimated failure probabilities tends to be the weak link in the analysis. Data on

component failure rates and estimates of fire event probability can lack adequate rigor. Incorporating expert opinion on system performance can be desirable or even required, if data are lacking. In addition, the uncertainty inherent in all statistical analysis should be reported for the failure probabilities.

E.2.6 Limitations of Testing and Protection Criteria. The objective of fire testing of large containers is to evaluate plausible scenarios. Attempts have been made to address variables that would contribute to failure or successful protection. All scenarios and probabilities are not addressed by virtue of the limited number of large-scale tests that can be practically conducted and inherent risks that are deemed acceptable, even with protected storage. Protection can be interpreted to mean control, suppression, or extinguishment of a fire for any given scenario. Subsection E.2.6 outlines issues and limitations associated with protected storage.

E.2.6.1 Ignition/Threat Scenarios. Worst-case scenarios (i.e., arson or terrorism) associated with breaches of multiple large containers have not been investigated. In such a scenario, the suppression system could also be rendered inoperative. Protected storage, as intended by this code, does not address this scenario. Attempts have been made in testing to develop a reasonable scenario that is challenging to the commodity and plausible under routine warehouse conditions. Different packaging systems could be more or less vulnerable to different scenarios. Small containers stored in corrugated cartons appear more vulnerable to small ignition sources because of delayed sprinkler actuation. Large containers could also react differently to the initiating scenario, depending on construction of the package. Large containers are typically tested with a relatively small initiating spill and a running fuel source. A large initial spill (i.e., where all the fuel in a container has emptied and is ignited) has not been tested. The relatively short duration of a large, thin spill fire is considered to be addressed by the threat of a much longer duration, shielded running fuel fire. A full range or combination of tests of initial spill size and spill rate has not been made. The philosophy in large container testing is to assume an initial container breach and provide control such that multiple containers do not breach and contribute to a much larger spill.

E.2.6.2 Water and Foam Sprinklers. Water sprinklers will not extinguish most flammable or combustible liquid fires. At best, water sprinklers will control or extinguish the fire in any associated combustible packaging material. Yet, most of the systems used in the protection criteria tables in Section 6.8 of this code are based on water sprinklers, based on the recognition of the following:

- (1) A large spill with small containers is unlikely, although not impossible, provided the sprinklers operate to control cascading breaching of containers.
- (2) There is sufficient cooling of larger containers to prevent multiple container breaching.

For large containers, some form of spill containment (e.g., by drainage) is required for protected storage. The intent is to limit the size of the spill and the resulting area of sprinkler operation. There has been little quantification of the appropriate design factors and effectiveness of drainage systems. For example, will protection be provided for a 370 m² (4000 ft²) area that is fully involved in fire? The duration of the fire could influence the

effectiveness of such protection.

Foam sprinklers are generally effective on pool (floor) fires but are likely to be ineffective on running, three-dimensional spill fires. Again, total control or extinguishment of the fire cannot be assured.

E.2.6.3 Anticipated Duration of the Fire. For large containers, particularly those greater than 208 L (55 gal) in capacity, there is an inherent assumption that manual fire-fighting efforts will be initiated to finalize control and extinguishment of the fire. For example, foam systems are required to have a duration of 15 minutes. This implies that some action will be taken when the system has been expended. The protection criteria for composite intermediate bulk containers were developed based on a 30-minute fire resistance for the container. Again, action to secure the situation after this time is assumed. The protection criteria for containers greater than 225 L (60 gal) capacity, as outlined in Table 6.8.2(a) through Table 6.8.2(d) and Table 6.8.2(i), provide reasonable containment confidence for a 30-minute fire exposure. Due to the capacity of intermediate bulk containers and portable tanks, it is imperative that response by a private fire brigade or public fire department be capable of initiating fire suppression activities promptly within this period.

Detection, notification, and prompt action by responsible personnel are implicit in the protection criteria. The protection system per se provides thermal detection. In some cases, more rapid detection could be desired. Considerations in evaluating appropriate detection requirements include level of fire department staffing, availability of an on-site fire brigade, and availability of off-site notification by a private service company.

Compliance with local and federal hazardous materials rules and regulations could result in delayed fire department action at the scene of a warehouse fire. Fire departments should also respond to fires in these occupancies with foam fire-fighting equipment to effect final extinguishment. The authority having jurisdiction should assess the capability of the fire department to effectively respond to the incident when implementing the protection criteria in this code. The selection of an approach to fire protection for these occupancies is influenced by the authority having jurisdiction, potential community or environmental exposures, investment at risk, insurance considerations, and business continuity.

E.2.7 References.

Gewain, R. G., "Fire Protection of Aerosol Products," *Southern Building Magazine*, September/October, 1996, pp 10–12.

Hill, J. P., "International Foam-Water Sprinkler Research Project: Task 3 — Range Finding Tests," Factory Mutual Research Report J.I. OTOR6.RR, prepared for the National Fire Protection Research Foundation, Norwood, MA, July 1991.

Newman, R. M., Fitzgerald, P. M., and Young, J. R., "Fire Protection of Drum Storage Using 'Light Water' Brand AFFF in a Closed-Head Sprinkler System," Factory Mutual Research Corporation Report FMRC Ser. No. 22464, RC75-T-16, Norwood, MA, March 1975.

Nugent, D. P., "Fire Tests Involving Storage of Flammable and Combustible Liquids in Small Containers," *Journal of Fire Protection Engineering* 6(1):1994; 1–10.

Copyright NFPA

Young, J. K., and Fitzgerald, P. M., “The Feasibility of Using ‘Light Water’ Brand AFFF in a Closed-Head Sprinkler System for Protection Against Flammable Liquid Spill Fires,” Factory Mutual Research Report FMRC Ser. No. 22352, RC75-T-4, Norwood, MA, January 1975.

E.2.8 Bibliography. Please note that reports by Factory Mutual Research Corporation (FMRC) cited in the bibliography might not be available to the general public. FMRC reports cited in the references are on file at NFPA Headquarters in the NFPA 30 committee files.

Allahdadi, F. A., Luehr, C., Morehouse, T., and Campbell, P., “Modeling Response of Tanks Containing Flammables to Fire Impingement,” ESL-TR-87-53, Engineering and Services Laboratory, Tyndall AFB, FL, July 1988.

American Petroleum Institute, API 2000, “Venting Atmospheric and Low Pressure Storage Tanks,” API, Washington, DC, 1982.

Bainbridge, B. L., and Keltner, N. R., “Heat Transfer to Large Objects in Large Pool Fires,” SAND-87-0641C, Sandia National Laboratories, Albuquerque, NM, 1987.

Birk, A. M., “Modeling the Effects of a Torch-Type Fire Impingement on a Rail or Highway Tanker,” *Fire Safety Journal* 15:1989; 277–296.

Committee on Hazardous Materials, Division of Chemistry and Chemical Technology, National Research Council (ed.), Pressure-Relieving Systems for Marine Cargo Bulk Liquid Containers, National Academy of Sciences, Washington, DC, 1973.

Factory Mutual Laboratories, Research Project No. 11365, November 2, 1949, “Fire Tests of Vent Fittings for Paint Drums,” Laboratory Report No. 13604, February 1958; 26.

Hall, J. R., Gandhi, P. D., and Sheppard, D. T., *Fire Risk Analysis for Flammable and Combustible Liquid Project — Containers in Storage and Retail Occupancies*, National Fire Protection Research Foundation, Quincy, MA, February, 1994.

Hall, J. R., “A Fire Risk Analysis Model for Assessing Options for Flammable and Combustible Liquid Products in Storage and Retail Occupancies,” *Fire Technology*, Vol. 31, No. 4, pp 291–306.

Johnson, M. R., “Temperatures, Pressures and Liquid Levels of Tank Cars Engulfed in Fires — Volume I, Results of Parametric Analyses,” DOT/FRA/OR&D-84/08.11, Federal Railroad Administration, Washington, DC, June 1984.

McLain, W. H., “Investigation of the Fire Safety Characteristics of Portable Tanks — Polyethylene Tanks Containing Flammable Liquids,” Report No. CG-M-1-88, U.S. Coast Guard Marine Technical and Hazardous Materials Division, Avery Point, CT, March 1988.

Nugent, D. P., Freeman, J. L., and Oliszewicz, M. P., *Guidelines for Safe Warehousing of Chemicals*, Center for Chemical Process Safety, American Institute of Chemical Engineers, New York NY, 1998, pp 113–119.

Richards, R. C., and White, K. T., “Fire Exposure Tests of Polyethylene and 55 Gallon Steel Drums Loaded with Flammable Liquids, Phase I,” Report No. CG-D-116-76, Department of Transportation, U.S. Coast Guard, Washington, DC, September 1976.

Copyright NFPA

Richards, R. C., and Munkenbeck, G. J., "Fire Exposure Tests of Polyethylene and 55 Gallon Steel Drums Loaded with Flammable Liquids, Phase II," Report No. CG-D-86-77, Department of Transportation, U.S. Coast Guard, Washington, DC, August 1977.

Rogerson, J. E., "Flammable and Combustible Liquid Drum Storage Problems," American Institute of Chemical Engineers Summer National Meeting Progress, Paper No. 63, 1981.

Russell, L. H. and Canfield, J. A., "Experimental Measurement of Heat Transfer to a Cylinder Immersed in a Large Aviation Fuel Fire," *Journal of Heat Transfer*, August 1973.

Scheffey, J. L., *International Intermediate Bulk Container Fire Test Project — Scoping Tests*, National Fire Protection Research Foundation, Quincy, MA, September, 1996.

Scheffey, J. L., Sheppard, D. T., and Stepan D., *International Intermediate Bulk Container Fire Test Project — Required Delivered Density Tests*, National Fire Protection Research Foundation, Quincy, MA, April, 1997.

Scheffey, J. L., Pabich, M., and Sheppard, D. T., *International Intermediate Bulk Container Fire Test Project — Phase IIA — Evaluation of Large Arrays*, National Fire Protection Research Foundation, Quincy, MA, April 1998.

Scheffey, J. L., Pabich, M., and Sheppard, D. T., *International Intermediate Bulk Container Fire Test Project — Phase IIB — Verification Tests and Development of Standardized Evaluation*, National Fire Protection Research Foundation, Quincy, MA, April, 1998.

Schemel, S. D., et al., "Methodology for Determining Reliability of a Foam Suppression System Using Fuzzy Set Theory and Fault Tree Analysis," *Proceedings of the International Conference and Workshop on Reliability and Risk Management*, Center for Chemical Process Safety, American Institute of Chemical Engineers, 1998.

Silicone Products Department of General Electric, "Bulging and Rupture Characteristics of 55-Gallon, Steel Closed-Top Drums at Known Pressure," Company Report No. R-65-Ch-SD-529, September 30, 1965.

Sumitra, P. S. and Troup, J. M. A., "The Effect on Sprinkler Protection of Using Thin Pallets for Palletized Barreled Whiskey Storage," FMRC J.I. OEOR1.RR, RC 79-T-60, March 1980.

Sumitra, P. S. and Troup, J. M. A., "Fire Protection Requirements for Six-Barrel High Palletized Storage of Distilled Spirits," FMRC J.I. OC2R6.RR, RC 78-T-42, February 1979.

Sumitra P. S. and Troup, J. M. A., "The Protection Requirements for Six-Barrel High Palletized Storage of Distilled Spirits, Phase II," FMRC J.I. OEOR1.RR, RC 79-T-66, November 1979.

Tavares, R. and Delichatsios, M. A., "Pressure Relief in Flammable-Liquid Drums by Pressure-Activated and Plastic Bunds," FMRC J.I. OFOR4.RA 070(A), Factory Mutual Research Corporation, Norwood, MA, March 1981.

Technical Report on Storage of Palletized Isopropyl Alcohol, Project 96NK33044/NC1838, Prepared for HSB Industrial Risk Insurers, Underwriters Laboratories, Inc., Northbrook, IL, April 18, 1997.

Copyright NFPA

Technical Report of Running Alcohol Fuel Fires Within Rack Storage of Plastic Drums, Project NC183897NK31221, Revised Draft, Underwriters Laboratories Inc., Northbrook, IL, July 15, 1998.

Yao, C., "Flammable Liquid Drum Fire Protection System Development," FMRC Report No. 16425, prepared for the Manufacturing Chemists Association, Norwood, MA, May 5, 1967.

Annex F Fugitive Emissions Calculations

This annex is not a part of the requirements of this NFPA document but is included for informational purposes only.

F.1 Introduction.

An alternative method of providing adequate ventilation for an enclosed area is by making a reasonable estimate of fugitive emissions from hydrocarbon-handling equipment within the enclosed area and providing sufficient diluent ventilation. Application of this method requires certain calculations, and one technique is described in Section F.2.

In calculating the ventilation rate required, the anticipated hydrocarbon leakage rate (under normal conditions) should be determined. Then, sufficient dilution air should be added to the space in question to ensure that the concentration of flammable vapor/gas is maintained below 25 percent of the lower flammable limit (LFL) for all but periods of process upset, abnormal operation, or equipment rupture, or breakdown.

Fugitive emission factors for specific hydrocarbon-handling equipment can be obtained from emission testing at specific facilities or from existing publications. A few existing publications are API's *Fugitive Hydrocarbon Emissions from Petroleum Production Operations*, Volumes I and II, 1980; *EPA/Radian Study* conducted in 1979; and *EPA Protocols for Generating Unit-Specific Emission Estimates for Equipment Leaks of VOC and HAP*, 1987 (Document No. 87-222-124-10-02). All emission data used should be reviewed to assure emission rates are representative of actual conditions during normal operations.

F.2 Calculation Technique.

In the following example, the required ventilation rate will be determined for an enclosed area on a cold-weather, offshore platform containing production equipment that measures 18 m (60 ft) by 36 m (120 ft) by 12 m (40 ft) high. The following procedure should be followed:

- (1) List the total applicable hydrocarbon-handling components and their anticipated total hydrocarbon fugitive emissions. The fugitive emissions equipment component leak rates can be obtained from emission measurements at the facility in question, from one of the existing publications listed in Section F.1, or from other studies that are representative of the equipment involved.
- (2) The total number of specific components handling hydrocarbons should be obtained by an actual field count for existing equipment or from the design drawings for

proposed equipment. Note that components handling gas should be listed separately from those handling liquid hydrocarbons.

- (3) Determine the total anticipated gas emission (pounds/day) for each component by multiplying the number of components by the applicable prediction factor. This product is the total gas emission anticipated for that specific type component.
- (4) Subtotal the total anticipated gas emissions (pounds/day) for all components to obtain the total gas service emission rate.
- (5) Repeat Steps (2) through (4) to determine the hydrocarbon liquids total anticipated emissions.
- (6) Add the subtotals from Steps (4) and (5) to determine the total anticipated emissions.
- (7) Convert the total hydrocarbon emission from pounds/day to pounds/hour. For the example chosen, assume that the total anticipated hydrocarbon emissions is 297.26 lb/day. Dividing by 24, the conversion yields 12.39 lb/hr.
- (8) Calculate the average mole weight of the hydrocarbon emissions. An example follows:

83% methane (Molecular Wt = 16)
13% ethane (Molecular Wt = 30)
4% butane (Molecular Wt = 58)
<u>100%</u>

$0.83 \times 16 = 13.28$
$0.13 \times 30 = 3.90$
$0.04 \times 58 = 2.32$
Total = 19.50

To simplify further calculations, the 19.5 is rounded to 20, and 20 is used as the average mole weight of the hydrocarbon emissions mixture.

- (9) Calculate the cubic feet/pound-mole at the estimated ambient temperature of the area. This calculation is made utilizing the fact that the volume of 1 pound-mole of an ideal gas is 359 ft³ at 32°F and 14.7 psia. From the Gas law ($PV = nRT$) and Charles' Gas law ($V_1T_2 = V_2T_1$), and from the fact that volume at constant pressure varies proportionately to the ratio of temperatures when the temperature is expressed in degrees Rankine (°F + 460), calculate the actual volume. Assuming an ambient temperature of 88°F, an example follows:

At 88°F and 14.7 psia, 359 ft³ of ideal gas would occupy:

$$359 \left(\frac{460 + 88}{460 + 32} \right) \text{ or } 400 \text{ ft}^3$$

- (10) Determine the total hydrocarbon leak rate in cubic feet per minute (cfm) using the following equation:

$$G = \frac{(E)(V)}{60(mw)}$$

where:

G = leak rate (cfm)
 E = emissions rate (lb/hr)
 V = volume (ft³/lb-mole)
 60 = min/hr
 mw = average mole weight

In our example, E equals 12.39 lb/hr, and the average mole weight is 20; therefore, G can be calculated as follows:

$$G = (12.39 \text{ lb/hr}) \left(\frac{400 \text{ ft}^3 / \text{lb-mole}}{60 \text{ min/hr}} \right) 20$$

$$G = 4.13 \text{ cfm}$$

- (11) As per NFPA 69, *Standard on Explosion Prevention Systems*, the hydrocarbon concentration can be expressed by the following equation:

$$C = \left(\frac{G}{Q} \right) (1 - e^{-kn})$$

where:

C = concentration of hydrocarbon in air, % expressed as a decimal
 G = leak rate (cfm)
 Q = fresh air introduction rate (cfm)
 k = mixing efficiency factor = 0.2 to 0.9
 n = number of air changes

The factor $(1 - e^{-kn})$ can be considered equal to 1 because as the number of air changes (n) approaches steady state (i.e., approximately three air changes), this factor approaches unity.

As an example, if the leakage rate is assumed to be 4.13 cfm, 100 percent LFL methane is assumed (5 percent concentration), and it is desired to maintain a 25 percent LFL mixture, the required fresh air introduction rate can be determined as follows:

$$Q = \frac{4.13 \text{ cfm}}{(0.25 \times 0.05)}$$

$$Q = 330 \text{ cfm}$$

- (12) Due to the variations in emission factors for processing equipment, the calculated

rate should be multiplied by a safety factor of 4. The required ventilation rate is determined as follows:

$$Q = 330 \text{ cfm} \times 4$$

$Q = 1320 \text{ cfm}$, the minimum ventilation rate

Thus, minimum ventilation to achieve adequate ventilation for an enclosed area of the size given in the example that contains the fugitive emissions sources assumed is 1320 cfm.

- (13) Depending on the size of the enclosed area and the equipment configuration, supplemental internal recirculation could be advisable to avoid areas of stagnation. With higher local concentrations where recirculation is justified, it should be designed with adequate air movement and direction to minimize “dead” areas where vapor can collect. If other criteria are lacking, a recirculation rate of 1 cfm/ft² of floor area can be used.
- (14) If conditions exist where there is a substantial risk of a large flammable vapor release in a confined space and the calculated rate of diluent ventilation is not sufficient to dilute and disperse the released vapor to below the LFL within 4 hours, then supplemental emergency ventilation should be produced. This can be by natural ventilation through panels or louvers, or by switching recirculation fans to full fresh air make-up, or exhaust. Consideration should be given to the travel direction of ventilated vapor to avoid its reaching an ignition source outside the enclosed space being ventilated.
- (15) The preceding procedure is adapted from “Module Ventilation Rates Quantified,” *Oil and Gas Journal*.

Annex G Sample Ordinance Adopting NFPA 30

This annex is not a part of the requirements of this NFPA document but is included for informational purposes only.

G.1

The following sample ordinance is provided to assist a jurisdiction in the adoption of this code and is not part of this code.

ORDINANCE NO. _____

An ordinance of the *[jurisdiction]* adopting the 2003 edition of NFPA 30, *Flammable and Combustible Liquids Code*, and documents listed in Chapter 2 of that *code*; prescribing regulations governing conditions hazardous to life and property from fire or explosion; providing for the issuance of permits and collection of fees; repealing Ordinance No.

_____ of the *[jurisdiction]* and all other ordinances and parts of ordinances in conflict therewith; providing a penalty; providing a severability clause; and providing for publication;

Copyright NFPA

and providing an effective date.

BE IT ORDAINED BY THE *[governing body]* OF THE *[jurisdiction]*:

SECTION 1 That the *[complete document title]* and documents adopted by Chapter 2, three (3) copies of which are on file and are open to inspection by the public in the office of the *[jurisdiction's keeper of records]* of the *[jurisdiction]*, are hereby adopted and incorporated into this ordinance as fully as if set out at length herein, and from the date on which this ordinance shall take effect, the provisions thereof shall be controlling within the limits of the *[jurisdiction]*. The same are hereby adopted as the *code* of the *[jurisdiction]* for the purpose of prescribing regulations governing conditions hazardous to life and property from fire or explosion and providing for issuance of permits and collection of fees.

SECTION 2 Any person who shall violate any provision of this code or standard hereby adopted or fail to comply therewith; or who shall violate or fail to comply with any order made thereunder; or who shall build in violation of any detailed statement of specifications or plans submitted and approved thereunder; or failed to operate in accordance with any certificate or permit issued thereunder; and from which no appeal has been taken; or who shall fail to comply with such an order as affirmed or modified by or by a court of competent jurisdiction, within the time fixed herein, shall severally for each and every such violation and noncompliance, respectively, be guilty of a misdemeanor, punishable by a fine of not less than \$ _____ nor more than \$ _____ or by imprisonment for not less than _____ days nor more than _____ days or by both such fine and imprisonment. The imposition of one penalty for any violation shall not excuse the violation or permit it to continue; and all such persons shall be required to correct or remedy such violations or defects within a reasonable time; and when not otherwise specified the application of the above penalty shall not be held to prevent the enforced removal of prohibited conditions. Each day that prohibited conditions are maintained shall constitute a separate offense.

SECTION 3 Additions, insertions, and changes æ that the *[year]* edition of NFPA 30, *[complete document title]* is amended and changed in the following respects:

List Amendments

SECTION 4 That ordinance No. _____ of *[jurisdiction]* entitled *[fill in the title of the ordinance or ordinances in effect at the present time]* and all other ordinances or parts of ordinances in conflict herewith are hereby repealed.

SECTION 5 That if any section, subsection, sentence, clause, or phrase of this ordinance is, for any reason, held to be invalid or unconstitutional, such decision shall not affect the validity or constitutionality of the remaining portions of this ordinance. The *[governing body]* hereby declares that it would have passed this ordinance, and each section, subsection, clause, or phrase hereof, irrespective of the fact that any one or more sections, subsections, sentences, clauses, and phrases be declared unconstitutional.

SECTION 6 That the *[jurisdiction's keeper of records]* is hereby ordered and directed to cause this ordinance to be published.

[NOTE: An additional provision may be required to direct the number of times the ordinance is to be published and to specify that it is to be in a newspaper in general circulation. Posting

Copyright NFPA

may also be required.]

SECTION 7 That this ordinance and the rules, regulations, provisions, requirements, orders, and matters established and adopted hereby shall take effect and be in full force and effect [time period] from and after the date of its final passage and adoption.

Annex H Informational References

H.1 Referenced Publications.

The following documents or portions thereof are referenced within this code for informational purposes only and are thus not part of the requirements of this document unless also listed in Chapter 2.

H.1.1 NFPA Publications. National Fire Protection Association, 1 Batterymarch Park, P.O. Box 9101, Quincy, MA 02269-9101.

NFPA 10, *Standard for Portable Fire Extinguishers*, 2002 edition.

NFPA 11A, *Standard for Medium- and High-Expansion Foam Systems*, 1999 edition.

NFPA 13, *Standard for the Installation of Sprinkler Systems*, 2002 edition.

NFPA 14, *Standard for the Installation of Standpipe and Hose Systems*, 2003 edition.

NFPA 15, *Standard for Water Spray Fixed Systems for Fire Protection*, 2001 edition.

NFPA 16, *Standard for the Installation of Foam-Water Sprinkler and Foam-Water Spray Systems*, 2003 edition.

NFPA 24, *Standard for the Installation of Private Fire Service Mains and Their Appurtenances*, 2002 edition.

NFPA 25, *Standard for the Inspection, Testing, and Maintenance of Water-Based Fire Protection Systems*, 2002 edition.

NFPA 30, *Flammable and Combustible Liquids Code*, 1993 edition.

NFPA 30B, *Code for the Manufacture and Storage of Aerosol Products*, 2002 edition.

NFPA 31, *Standard for the Installation of Oil-Burning Equipment*, 2001 edition.

NFPA 51B, *Standard for Fire Prevention During Welding, Cutting, and Other Hot Work*, 2003 edition.

NFPA 58, *Liquefied Petroleum Gas Code*, 2001 edition.

NFPA 68, *Guide for Venting of Deflagrations*, 2002 edition.

NFPA 69, *Standard on Explosion Prevention Systems*, 2002 edition.

NFPA 70, *National Electrical Code*®, 2002 edition.

NFPA 72®, *National Fire Alarm Code*®, 2002 edition.

Copyright NFPA

NFPA 77, *Recommended Practice on Static Electricity*, 2000 edition.

NFPA 90A, *Standard for the Installation of Air-Conditioning and Ventilating Systems*, 2002 edition.

NFPA 91, *Standard for Exhaust Systems for Air Conveying of Vapors, Gases, Mists, and Noncombustible Particulate Solids*, 1999 edition.

NFPA 101[®], *Life Safety Code[®]*, 2003 edition.

NFPA 204, *Standard for Smoke and Heat Venting*, 2002 edition.

NFPA 220, *Standard on Types of Building Construction*, 1999 edition.

NFPA 306, *Standard for the Control of Gas Hazards on Vessels*, 2003 edition.

NFPA 326, *Standard for the Safeguarding of Tanks and Containers for Entry, Cleaning, or Repair*, 1999 edition.

NFPA 329, *Recommended Practice for Handling Releases of Flammable and Combustible Liquids and Gases*, 1999 edition.

NFPA 385, *Standard for Tank Vehicles for Flammable and Combustible Liquids*, 2000 edition.

NFPA 496, *Standard for Purged and Pressurized Enclosures for Electrical Equipment*, 2003 edition.

NFPA 497, *Recommended Practice for the Classification of Flammable Liquids, Gases, or Vapors and of Hazardous (Classified) Locations for Electrical Installations in Chemical Process Areas*, 1997 edition.

NFPA 505, *Fire Safety Standard for Powered Industrial Trucks Including Type Designations, Areas of Use, Conversions, Maintenance, and Operation*, 2002 edition.

NFPA 704, *Standard System for the Identification of the Hazards of Materials for Emergency Response*, 2001 edition.

Fire Protection Guide to Hazardous Materials, 2002.

Flammable and Combustible Liquids Code Handbook, 1996.

NFPA Haz-Mat Quick Guide.

Hall, John R., Jr., Ph.D., “A Fire Risk Analysis Model for Assessing Options for Flammable and Combustible Liquid Products in Storage and Retail Occupancies,” *Fire Technology*, Vol. 31, No. 4, November 1995, pp 291–306.

H.1.2 Other Publications.

H.1.2.1 AIChE Publication. American Institute of Chemical Engineers, 345 East 47th Street, New York, NY 10017.

Fisher, H.G. and Forrest, H.S., “Protection of Storage Tanks from Two-Phase Flow Due to Fire Exposure,” *Process Safety Progress*, Vol. 14, July, 1995, pp. 183-199.

Copyright NFPA

Guidelines for Pressure Relief and Effluent Handling Systems, 1998.

Houser, J., et al, "Vent Sizing for Fire Considerations: External Fire Duration, Jacketed Vessels, and Heat Flux Variations Owing to Fuel Consumption," *Journal of Loss Prevention in the Process Industries*, Vol. 14 No. 5, September 2001, pp. 403-412.

Nugent, D.P., Freeman, J.L., and Oliszewicz, M.P., *Guidelines for Safe Warehousing of Chemicals*, 1998.

H.1.2.2 API Publications. American Petroleum Institute, 1220 L Street, NW, Washington, DC 20005.

API 12RI, *Setting, Maintenance, Inspection, Operation, and Repair of Tanks in Production Service*.

API 620, *Recommended Rules for the Design and Construction of Large, Welded, Low-Pressure Storage Tanks*, 10th edition, 2001.

API Standard 650, *Welded Steel Tanks for Oil Storage*, 10th edition, 1998.

API 653, *Tank Inspection, Repair, Alteration, and Reconstruction*, 3rd edition, 2001.

API 1604, *Removal and Disposal of Used Underground Petroleum Storage Tanks*, 3rd edition, 1996.

API RP 1615, *Installation of Underground Petroleum Storage Systems*, 5th edition, 1996.

API 1631, *Interior Lining of Underground Storage Tanks*, 5th edition, 2001.

API RP 1632, *Cathodic Protection of Underground Petroleum Storage Tanks and Piping Systems*, 3rd edition, 1996.

API 2003, *Protection Against Ignition Arising Out of Static, Lightning, and Stray Currents*, 6th edition, 1998.

API 2015, *Cleaning Petroleum Storage Tanks*, 6th edition, 2001.

API 2015A, *A Guide to Controlling the Lead Hazard Associated with Tank Entry and Cleaning*.

API 2015B, *Cleaning Open Top and Covered Floating Roof Tanks*.

API 2217A, *Guidelines for Work in Inert Confined Spaces in the Petroleum Industry*, 2nd edition, 1987.

API 2218, *Fireproofing Practices in Petroleum and Petrochemical Processing Plants*, 2nd edition, 1999.

API 2219, *Safe Operating Guidelines for Vacuum Trucks in Petroleum Service*, 2nd edition, 1999.

API 2350, *Overflow Protection for Storage Tanks in Petroleum Facilities*, 2nd edition, 1996.

"An Engineering Analysis of the Effects of Oxygenated Fuels on Marketing Vapor Recovery Equipment," September 1990.

Copyright NFPA

Fugitive Hydrocarbon Emissions from Petroleum Production Operations, Volumes I and II, 1980.

H.1.2.3 Association of Canadian Distillers Publication. Association of Canadian Distillers, Suite 518, 90 Rue Sparks, Ottawa, Ontario, K1P 5B4, Canada.

“Fire Tests of Distilled Spirits Storage Tanks,” Client Report CR-5727.1.

H.1.2.4 ASTM Publications. American Society for Testing and Materials, 100 Barr Harbor Drive, West Conshohocken, PA 19428-2959.

ASTM D 86, *Standard Method of Test for Distillation of Petroleum Products*, 2000.

ASTM D 92, *Standard Test Method for Flash and Fire Points by Cleveland Open Cup*, 1998.

ASTM D 323, *Standard Method of Test for Vapor Pressure of Petroleum Products (Reid Method)*, 1999.

ASTM D 4206, *Standard Test Method for Sustained Burning of Liquid Mixtures Using the Small Scale Open-Cup Apparatus*, 2001.

ASTM D 4207, *Standard Test Method for Sustained Burning of Low Viscosity Liquid Mixtures by the Wick Test*.

ASTM E 119, *Standard Test Methods for Fire Tests of Building Construction and Materials*, 2000.

ASTM E 502, *Standard Test Method for Selection and Use of ASTM Standards for the Determination of Flash Point of Chemicals by Closed Cup Methods*, 1994.

ASTM Manual on Flash Point Standards and Their Use.

H.1.2.5 NACE Publications. National Association of Corrosion Engineers, 1440 South Creek Drive, Houston, TX 77084.

NACE Standard RP-0169, *Recommended Practice, Control of External Corrosion of Underground or Submerged Metallic Piping Systems*, 1996.

NACE Standard RP-0285, *Recommended Practice, Corrosion Control of Underground Storage Tank Systems by Cathodic Protection*, 1995.

H.1.2.6 NEIWPCC Publication. New England Interstate Water Pollution Control Commission, 85 Merrimac Street, Boston, MA 02114.

Tank Closure Without Tears: An Inspector’s Safety Guide, May 1988.

H.1.2.7 Oil and Gas Journal Publication. PennWell Publishing Co., 3050 Post Oak Boulevard, Houston, TX 77056.

“Module Ventilation Rates Quantified,” W. E. Gale, December 23, 1985, p. 41.

H.1.2.8 PEI Publications. Petroleum Equipment Institute, P.O Box 2380, Tulsa, OK 74101-2380.

PEI RP100, *Recommended Practices for Installation of Underground Liquid Storage Systems*, 1990.

PEI RP200, *Recommended Practices for Installation of Aboveground Storage Systems for Motor Vehicle Fueling*, 1994.

H.1.2.9 SFPE Publication. Society of Fire Protection Engineers, 7315 Wisconsin Avenue, Suite 1225 W, Bethesda, MD 20814.

Directory of Fire Tests Involving Storage of Flammable and Combustible Liquids in Small Containers, by David P. Nugent, Schirmer Engineering Corporation.

H.1.2.10 STI Publication. Steel Tank Institute, 570 Oakwood Road, Lake Zurich, IL 60047.

STI-P₃, *Specification and Manual for External Corrosion Protection of Underground Steel Storage Tanks*, 1996.

STI R931, *Double Wall AST Installation and Testing Instructions*, 1993.

STI RP892, *Recommended Practice for Corrosion Protection of Underground Piping Networks Associated with Liquid Storage and Dispensing Systems*, 1991.

STI SP001, *Standard for Inspection of In-Service Shop Fabricated Aboveground Tanks for Storage of Combustible and Flammable Liquids*, 2001.

STI, ACT-100®, *Specification for External Corrosion Protection of FRP Composite Steel Underground Tanks*, F894, 1997.

H.1.2.11 UL Publications. Underwriters Laboratories Inc., 333 Pfingsten Road, Northbrook, IL 60062.

UL 142, *Standard for Steel Aboveground Tanks for Flammable and Combustible Liquids*, 1993.

UL 1316, *Standard for Glass-Fiber-Reinforced Plastic Underground Storage Tanks for Petroleum Products, Alcohols, and Alcohol-Gasoline Mixtures*, 1983.

UL 1709, *Standard for Rapid Rise Fire Tests of Protection Materials for Structural Steel*, 1994.

UL 1746, *Standard for External Corrosion Protection Systems for Steel Underground Storage Tanks*, 1993.

UL 2085, *Standard for Protected Aboveground Tanks for Flammable and Combustible Liquids*, 1997.

H.1.2.12 ULC Publication. Underwriters' Laboratories of Canada, 7 Crouse Road, Scarborough, Ontario MIR 3A9, Canada.

ULC-S603.1M, *Standard for Galvanic Corrosion Protection Systems for Steel Underground Tanks for Flammable and Combustible Liquids*.

H.1.2.13 U.S. Government Publications. U.S. Government Printing Office, Washington,

Copyright NFPA

DC 20402.

EPA Protocols for Generating Unit-Specific Emission Estimates for Equipment Leaks of VOC and HAP, 1987 (Document No. 87-222-124-10-02).

EPA/Radian Study, 1979.

Title 21, *Code of Federal Regulations*, “GMP for Medical Devices.”

Title 29, *Code of Federal Regulations*, Part 1910.106.

Title 33, *Code of Federal Regulations*, Parts 154–156, “Navigation and Navigable Waterways.”

Title 40, *Code of Federal Regulations*, Part 280, “Technical Standards and Requirements for Owners and Operators of Underground Storage Tanks.”

Title 46, *Code of Federal Regulations*, Parts 30, 32, 35, and 39, “Shipping.”

Title 49, *Code of Federal Regulations*, Parts 100–199, “Hazardous Materials Transportation.”

National Institute for Occupational Safety and Health (NIOSH), *Criteria for Recommended Standard for Working in Confined Spaces*, 1979.

NIOSH 87–113, *A Guide to Safety in Confined Spaces*, 1987.

Occupational Health & Safety Administration (OSHA) 2226, *Excavation & Trenching Operations*, 1990.

H.1.3 References for Annex E.

Gewain, R. G., “Fire Protection of Aerosol Products,” *Southern Building Magazine*, September/October, 1996, pp. 10–12.

Hill, J. P., “International Foam-Water Sprinkler Research Project: Task 3 — Range Finding Tests,” Factory Mutual Research Report J.I. OTOR6.RR, prepared for the National Fire Protection Research Foundation, Norwood, MA, July 1991.

Newman, R. M., Fitzgerald, P. M., and Young, J. R., “Fire Protection of Drum Storage Using ‘Light Water’ Brand AFFF in a Closed-Head Sprinkler System,” Factory Mutual Research Corporation Report FMRC Ser. No. 22464, RC75-T-16, Norwood, MA, March 1975.

Nugent, D. P., “Fire Tests Involving Storage of Flammable and Combustible Liquids in Small Containers,” *Journal of Fire Protection Engineering* 6(1):1994; 1–10.

Young, J. K., and Fitzgerald, P. M., “The Feasibility of Using ‘Light Water’ Brand AFFF in a Closed-Head Sprinkler System for Protection Against Flammable Liquid Spill Fires,” Factory Mutual Research Report FMRC Ser. No. 22352, RC75-T-4, Norwood, MA, January 1975.

H.2 Informational References.

The following documents or portions thereof are listed here as informational resources only.

Copyright NFPA

They are not a part of the requirements of this document.

Allahdadi, F. A., Luehr, C., Morehouse, T., and Campbell, P., "Modeling Response of Tanks Containing Flammables to Fire Impingement," ESL-TR-87-53, Engineering and Services Laboratory, Tyndall AFB, FL, July 1988.

American Petroleum Institute, API 2000, "Venting Atmospheric and Low Pressure Storage Tanks," API, Washington, DC, 1982.

Bainbridge, B. L., and Keltner, N. R., "Heat Transfer to Large Objects in Large Pool Fires," SAND-87-0641C, Sandia National Laboratories, Albuquerque, NM, 1987.

Birk, A. M., "Modeling the Effects of a Torch-Type Fire Impingement on a Rail or Highway Tanker," *Fire Safety Journal* 15:1989; 277–296.

Committee on Hazardous Materials, Division of Chemistry and Chemical Technology, National Research Council (ed.), Pressure-Relieving Systems for Marine Cargo Bulk Liquid Containers, National Academy of Sciences, Washington, DC, 1973.

Factory Mutual Laboratories, Research Project No. 11365, November 2, 1949, "Fire Tests of Vent Fittings for Paint Drums," Laboratory Report No. 13604, February 1958; 26.

Hall, J. R., Gandhi, P. D., and Sheppard, D. T., *Fire Risk Analysis for Flammable and Combustible Liquid Project — Containers in Storage and Retail Occupancies*, National Fire Protection Research Foundation, Quincy, MA, February, 1994.

Hall, J. R., "A Fire Risk Analysis Model for Assessing Options for Flammable and Combustible Liquid Products in Storage and Retail Occupancies," *Fire Technology*, Vol. 31, No. 4, pp 291–306.

Houser, J., et al., "Vent Sizing for Fire Considerations: External Fire Duration, Jacketed Vessels, and Heat Flux Variations Owing to Fuel Consumption," *Journal of Loss Prevention in the Process Industries*, Vol. 14, pp. 403–412.

Johnson, M. R., "Temperatures, Pressures and Liquid Levels of Tank Cars Engulfed in Fires — Volume I, Results of Parametric Analyses," DOT/FRA/OR&D-84/08.11, Federal Railroad Administration, Washington, DC, June 1984.

McLain, W. H., "Investigation of the Fire Safety Characteristics of Portable Tanks — Polyethylene Tanks Containing Flammable Liquids," Report No. CG-M-1-88, U.S. Coast Guard Marine Technical and Hazardous Materials Division, Avery Point, CT, March 1988.

Nugent, D.P., Freeman, J.L., and Oliszewicz, M.P., *Guidelines for Safe Warehousing of Chemicals*, Center for Chemical Process Safety, American Institute of Chemical Engineers, New York NY, 1998, pp 113–119.

Richards, R. C., and White, K. T., "Fire Exposure Tests of Polyethylene and 55 Gallon Steel Drums Loaded with Flammable Liquids, Phase I," Report No. CG-D-116-76, Department of Transportation, U.S. Coast Guard, Washington, DC, September 1976.

Richards, R. C., and Munkenbeck, G. J., "Fire Exposure Tests of Polyethylene and 55 Gallon Steel Drums Loaded with Flammable Liquids, Phase II," Report No. CG-D-86-77,

Department of Transportation, U.S. Coast Guard, Washington, DC, August 1977.

Rogerson, J. E., "Flammable and Combustible Liquid Drum Storage Problems," American Institute of Chemical Engineers Summer National Meeting Progress, Paper No. 63, 1981.

Russell, L. H. and Canfield, J. A., "Experimental Measurement of Heat Transfer to a Cylinder Immersed in a Large Aviation Fuel Fire," *Journal of Heat Transfer*, August 1973.

Scheffey, J. L., *International Intermediate Bulk Container Fire Test Project — Scoping Tests*, National Fire Protection Research Foundation, Quincy, MA, September, 1996.

Scheffey, J. L., Sheppard, D. T., and Steppan D., *International Intermediate Bulk Container Fire Test Project — Required Delivered Density Tests*, National Fire Protection Research Foundation, Quincy, MA, April, 1997.

Scheffey, J. L., Pabich, M., and Sheppard, D. T., *International Intermediate Bulk Container Fire Test Project — Phase IIA — Evaluation of Large Arrays*, National Fire Protection Research Foundation, Quincy, MA, April 1998.

Scheffey, J. L., Pabich, M., and Sheppard, D. T., *International Intermediate Bulk Container Fire Test Project — Phase IIB — Verification Tests and Development of Standardized Evaluation*, National Fire Protection Research Foundation, Quincy, MA, April, 1998.

Schemel, S. D., et al., "Methodology for Determining Reliability of a Foam Suppression System Using Fuzzy Set Theory and Fault Tree Analysis," *Proceedings of the International Conference and Workshop on Reliability and Risk Management*, Center for Chemical Process Safety, American Institute of Chemical Engineers, 1998.

Silicone Products Department of General Electric, "Bulging and Rupture Characteristics of 55-Gallon, Steel Closed-Top Drums at Known Pressure," Company Report No. R-65-Ch-SD-529, September 30, 1965.

Sumitra, P. S. and Troup, J. M. A., "The Effect on Sprinkler Protection of Using Thin Pallets for Palletized Barrelled Whiskey Storage," FMRC J.I. OEOR1.RR, RC 79-T-60, March 1980.

Sumitra, P. S. and Troup, J. M. A., "Fire Protection Requirements for Six-Barrel High Palletized Storage of Distilled Spirits," FMRC J.I. OC2R6.RR, RC 78-T-42, February 1979.

Sumitra P. S. and Troup, J. M. A., "The Protection Requirements for Six-Barrel High Palletized Storage of Distilled Spirits, Phase II," FMRC J.I. OEOR1.RR, RC 79-T-66, November 1979.

Tavares, R. and Delichatsios, M. A., "Pressure Relief in Flammable-Liquid Drums by Pressure-Activated and Plastic Bunds," FMRC J.I. OFOR4.RA 070(A), Factory Mutual Research Corporation, Norwood, MA, March 1981.

Technical Report on Storage of Palletized Isopropyl Alcohol, Project 96NK33044/NC1838, Prepared for HSB Industrial Risk Insurers, Underwriters Laboratories, Inc., Northbrook, IL, April 18, 1997.

Technical Report of Running Alcohol Fuel Fires Within Rack Storage of Plastic Drums, Project NC183897NK31221, Revised Draft, Underwriters Laboratories Inc., Northbrook, Copyright NFPA

IL, July 15, 1998.

Yao, C., “Flammable Liquid Drum Fire Protection System Development,” FMRC Report No. 16425, prepared for the Manufacturing Chemists Association, Norwood, MA, May 5, 1967.

H.3 References for Extracts.

The following documents are listed here to provide reference information, including title and edition, for extracts given throughout this code as indicated by a reference in brackets [] following a section or paragraph. These documents are not a part of the requirements of this document unless also listed in Chapter 2 for other reasons.

NFPA 1, *Uniform Fire Code*TM, 2003 edition.

NFPA 45, *Standard on Fire Protection for Laboratories Using Chemicals*, 2000 edition.

NFPA 52, *Compressed Natural Gas (CNG) Vehicular Fuel Systems Code*, 2002 edition.

NFPA 55, *Standard for the Storage, Use, and Handling of Compressed Gases and Cryogenic Fluids in Portable and Stationary Containers, Cylinders, and Tanks*, 2003 edition.

NFPA 101[®], *Life Safety Code*[®], 2003 edition.

NFPA 307, *Standard for the Construction and Fire Protection of Marine Terminals, Piers, and Wharves*, 2000 edition.

Formal Interpretation

Formal Interpretation

NFPA 30

Flammable and Combustible Liquids Code

2003 Edition

Reference: 1.1, Scope
F.I. 84-4

Background: Tank trailers and semi-trailers are loaded with flammable or combustible liquid and moved to a storage yard. There, the tank vehicles may be kept for days, weeks, or months before being shipped to another location or being moved to another part of the same plant site. Some of the tank vehicles are not road-worthy.

Question: Do such tank vehicles, used for the temporary storage of flammable and combustible liquids, need to meet the requirements of NFPA 30 for drainage, impoundment, separation distances, etc.?

Answer: Yes.

Issue Edition: 1984

Reference: 1-1

Date: April 1987

Copyright © 2003 All Rights Reserved
NATIONAL FIRE PROTECTION ASSOCIATION

Formal Interpretation

NFPA 30

Flammable and Combustible Liquids Code

2003 Edition

Reference: 1.1.1, 1.1.2(1), 7.3.7.1

F.I. 93-1 (NFPA 30)

Question: Since the term "solid" is not defined by NFPA 30, is it the intent of Subsections 1.1.1 and 1.1.2(1) of NFPA 30 that a combustible material, having a melting point at or above 100°F, be outside the scope of NFPA 30 and exempt from NFPA 30's requirements?

Answer: Yes.

Issue Edition: 1993

Reference: 1-1.1, 1-1.3, 5-4.1.1

Issue Date: March 7, 1995

Effective Date: March 27, 1995

Copyright © 2003 All Rights Reserved
NATIONAL FIRE PROTECTION ASSOCIATION

Formal Interpretation

NFPA 30

Flammable and Combustible Liquids Code

2003 Edition

Reference: 3.3.5

F.I. 81-1

Question: Is it the intent of NFPA 30 that Fuel Oil #6 be considered a boil-over liquid, as per the definition of boil-over, viz., crude oil (or certain other liquids) and as per the applicability of Table 4.3.2.1.3 of NFPA 30 governing boil-over liquids?

Answer: No.

Issue Edition: 1981

Reference: 1-2

Date: April 1981

Copyright © 2003 All Rights Reserved
NATIONAL FIRE PROTECTION ASSOCIATION

Formal Interpretation

NFPA 30

Flammable and Combustible Liquids Code

2003 Edition

Reference: 4.3.1.3

F.I. 87-1

Background: Chapter 1 of NFPA 30 defines a portable tank as “any closed vessel having a liquid capacity over 60 U.S. gallons and not intended for fixed installation”.

Paragraph 6.1.1 of NFPA 30 states “This chapter shall apply to the storage of . . . portable tanks not exceeding 660 gallons individual capacity . . . For portable tanks exceeding 660 gallons, Chapter 2 shall apply”.

Question: Does a portable tank that:

- does not exceed 660 gallons;
- is located at least 50 feet from the battery limits of any process area or from any building;
- is elevated above grade on steel angle iron supports;
- can be and is routinely moved by means of an industrial (fork-lift) truck;
- is used to refuel portable compressors and welding generators;

need to comply with the requirement for protection by “materials having a fire resistance rating of not less than 2 hours”, as set forth for tanks in 4.3.1.3.

Answer: No.

Issue Edition: 1987

Reference: 2-5.1, 2-5.2, 2-5.3

Date: December 1987

Copyright © 2003 All Rights Reserved
NATIONAL FIRE PROTECTION ASSOCIATION

Formal Interpretation

NFPA 30

Flammable and Combustible Liquids Code

2003 Edition

Reference: 4.3.4

F.I. 90-1

Background: Hydraulic elevator systems commonly use low-pressure tanks as accumulator reservoirs to contain the hydraulic oil that is pumped into and out of the hydraulic cylinder. The question has arisen whether these reservoirs are subject to the provisions of NFPA 30, specifically the provisions of 4.3.4. Specific provisions for such accumulator tanks are not mentioned in any other code, including the ANSI standards that deal specifically with elevator systems.

Question: Are the hydraulic accumulator reservoirs of a hydraulic elevator system subject to the provisions of NFPA 30, paragraph 4.3.4, Installation of Tanks Inside of Buildings?

Answer: No.

Issue Edition: 1990

Reference: 2-5

Issue Date: January 22, 1991

Effective Date: February 11, 1991

Copyright © 2003 All Rights Reserved
NATIONAL FIRE PROTECTION ASSOCIATION

Formal Interpretation

NFPA 30

Flammable and Combustible Liquids Code

2003 Edition

Reference: 5.5.6

FI N/A

Question: Does the requirement for check valves for automatic protection against back-flow in 5.5.6 apply to marine unloading facilities?

Answer: Paragraphs 7.7.7 through 7.7.11 are applicable to marine flammable and combustible liquids wharves at bulk plants and provide exceptions and additions to Chapter 3, including 5.5.6. Use of check valves in tanker and barge unloading lines is not mandatory, but 7.7.9(4) requires the installation of block valves to control flow in the event of physical damage.

Issue Edition: 1976

Reference: 3-6.1

Issue Date: January, 1978

Reissued: January, 1994

Copyright © 2003 All Rights Reserved
NATIONAL FIRE PROTECTION ASSOCIATION

Formal Interpretation

NFPA 30

Flammable and Combustible Liquids Code

2003 Edition

Reference: 6.2

F.I. 90-2

Background: An intermediate bulk container (IBC), referred to in Section 6.2 of NFPA 30 as a "portable tank," that is constructed of a blow-molded plastic bottle, of 61 to 660 gallons capacity, that is structurally supported by a metal overpack and is attached to a pallet. The plastic overpack provides primary liquid containment. The sheet metal overpack provides structural rigidity and impact protection, but is not liquidtight.

Question: Does a container such as described meet the intent of the phrase "approved metal portable tank" as cited in Section 6.2 of NFPA 30?

Answer: No.

Issue Edition: 1990

Reference: 4-2

Issue Date: January 22, 1991

Effective Date: February 11, 1991

Copyright © 2003 All Rights Reserved
NATIONAL FIRE PROTECTION ASSOCIATION

Formal Interpretation

NFPA 30

Flammable and Combustible Liquids Code

2003 Edition

Reference: 6.2.3.1

F.I. 81-2

Question: Is it the intent of NFPA 30, 6.2.3.1 to exempt kerosene fuel with a flash point of 150°F stored in 2- to 2¹/₂-gallon non-listed plastic containers for retail sales from the requirements of 6.2.1 and 6.2.3?

Answer: No.

Issue Edition: 1981

Reference: 4-2.3.1

Date: December 1982

Copyright © 2003 All Rights Reserved
NATIONAL FIRE PROTECTION ASSOCIATION

Formal Interpretation

NFPA 30

Flammable and Combustible Liquids Code

2003 Edition

Reference: Table A.6.8.2(b)

F.I. 84-3

Question 1: Does the column in Table A.6.8.2(b), headed "Maximum Quantity of Containers (gal)" apply to the total quantity allowed in a single rack?

Answer: Yes.

Question 2: Does the column in Table A.6.8.2(b), headed "Maximum Quantity of Containers (gal)" also apply to the total quantity allowed in the entire fire area?

Answer: Yes

Issue Edition: 1984

Reference: Table 4-6.1(b)

Date: April 1987

Reissued: August 1995

Copyright © 2003 All Rights Reserved
NATIONAL FIRE PROTECTION ASSOCIATION

Formal Interpretation

NFPA 30

Flammable and Combustible Liquids Code

2003 Edition

Reference: Table 8.2.2

F. I. No.: 30-03-1

Background: In Table 8.2.2, the electrical area classification for “Office and rest rooms”, “Garages for other than tank vehicles”, and “Indoor warehousing where there is no flammable liquid transfer” is listed as “Ordinary”, i.e., no area classification applies. However, each of these three entries includes a qualifying statement that reads “If there is any opening to these rooms within the extent of an indoor classified location, the room shall be classified the same as if the wall, curb, or partition did not exist”

Question: Is it the intent of the qualifying statement to require that the classified area extend through the opening(s) only to the distance specified by Table 8.2.2 for the specific source(s) that requires area classification?

Answer: Yes.

Issue Edition: 2003

Reference: Table 8.2.2

Issue Date: May 8, 2006

Effective Date: May 28, 2006

Copyright © 2006 All Rights Reserved
NATIONAL FIRE PROTECTION ASSOCIATION

Tentative Interim Amendment

NFPA 30

Flammable and Combustible Liquids Code

2003 Edition

Reference: 6.2.1, A.6.2.1, 6.2.3, Table 6.2.3
TIA 03-1 (NFPA 30)
(SC-04-7-12/Log 793)

Pursuant to Section 5 of the NFPA Regulations Governing Committee Projects, the National Fire Protection Association has issued the following Tentative Interim Amendment to NFPA 30, *Flammable and Combustible Liquids Code*, 2003 edition. The TIA was processed by the Flammable and Combustible Liquids Committee, and was issued by the Standards Council on July 15, 2004, with an effective date of August 4, 2004.

A Tentative Interim Amendment is tentative because it has not been processed through the entire standards-making procedures. It is interim because it is effective only between editions of the standard. A TIA automatically becomes a proposal of the proponent for the next edition of the standard; as such, it then is subject to all of the procedures of the standards-making process.

1. *Revise Subsection 6.2.1 to read as follows:*

6.2.1* Only the following approved containers, intermediate bulk containers, and portable tanks shall be used for Class I, Class II, and Class IIIA liquids.

2. *Add a new Annex item to 6.2.1 to read as follows:*

A.6.2.1 It is not the intent of Section 6.2 to regulate containers and packaging systems for Class IIIB liquids, except as required for protected storage in accordance with Section 6.8.

3. *Revise Subsection 6.2.3 to read as follows:*

6.2.3 The maximum allowable size of a container, intermediate bulk container, or metal portable tank for Class I, Class II, and Class IIIA liquids shall not exceed that specified in Table 6.2.3.

4. *In Table 6.2.3, in the last column heading, change the column heading from Class III to Class IIIA.*